

ALICANTE / MARBELLA 100

PL> INSTRUKCJA MONTAŻU
D >MONTAGEANLEITUNG
GB>ASSEMBLY INSTRUCTIONS
NL>HANDLEIDING VOOR DE MONTAGE
F >MODEL D'EMPLOI
CZ> POKYNY PRO INSTALACI
SK> INSTRUKCJA MONTAŽUNÁVOD

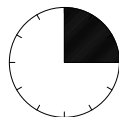

280
minut
minuten
minutes
minutes

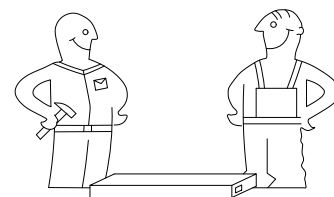
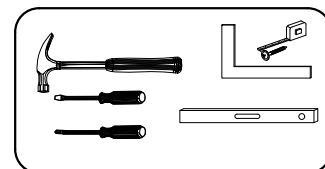

NA INŠTALÁCIU
HR> UPUTE ZA MONTAŽU
SRB> УПУТСТВО ЗА УГРАДЊУ
I >ISTRUZIONI PER L'INSTALLAZIONE
E >INSTRUCCIONES DE INSTALACIÓN

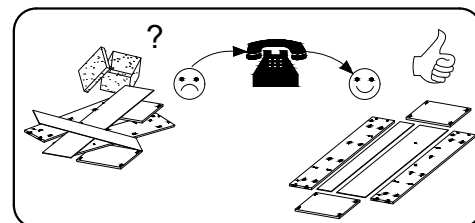
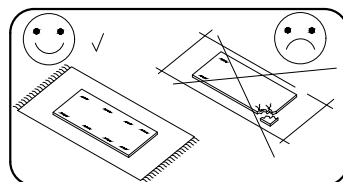
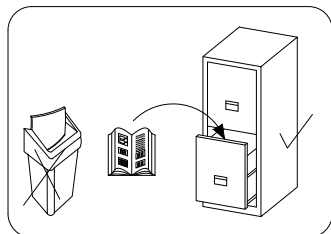

**Uwaga / Achtung / Caution / Opgelet / Attention /
Pozornost / Pozornost' / Pažnja / Пажња / Attenzione / Atención**



PL>Czyszczenie należy wykonać wyłącznie za pomocą ściereczki lub lekko nawilżonego ręcznika.
Nie stosować środków czyszczących do szorowania.

Szanowny kliencie, jeśli podczas montażu stwierdzisz uszkodzenie lub brak części, proszę podaj jej kod alfanumeryczny lub zaznacz ją na instrukcji montażu i prześlij wraz z protokołem reklamacyjnym

D >Bitte nur mit einem Staubtuch oder leicht feuchtem Lappen reinigen. Keine scheuerenden Putzmittel verwenden.

Sehr geehrter Kunde, sollte ein Teil fehlen oder beschädigt sein, kreuzen Sie dies bitte deutlich auf der Montageanleitung an und schicken Sie die Montageanleitung mit ein.

GB>Please only clean with a duster or a damp cloth. Do not use any abrasive cleaners.

Dear customer, should there be any piece missing or damaged, kindly mark this piece clearly on the attached assembly instructions and return them to us.

NL>Reinig alleen met een stofdoek of een lichtjes vochtige doek. Gebruik geen schurende poetsmiddelen.

Geachte klant, in het geval van beschadiging of ontbrekende onderdelen tijdens de montage, gelieve de alfanumerieke code in de montagehandleiding te vermelden of te markeren en samen met het klachtenprotocol mee te sturen

F >Le nettoyage se fait uniquement à l'aide d'un torchon ou d'une serviette légèrement mouillée.

Cher client, en cas de dommages ou de pièces manquantes lors du montage, veuillez fournir ou marquer le code alphanumérique dans le manuel de montage et l'envoyer avec le protocole de réclamation

CZ>Čištění by mělo být prováděno pouze hadříkem nebo mírně navlhčeným hadříkem.
Nepoužívejte abrazivní čisticí prostředky.

Vážený zákazníku, pokud při montáži zjistíte poškozený nebo chybějící díl, uveďte jeho alfanumerický kód nebo jej označte v montážním návodu a zašlete spolu s reklamačním protokolem

SK>Čistenie by sa malo vykonávať iba handričkou alebo mierne navlhčenou utierkou. Nepoužívajte čistiace prostriedky na drhnutie..

Vážený zákazník, ak pri montáži nájdete poškodený alebo chýbajúci diel, uveďte jeho alfanumerický kód alebo ho označte na montážnom návode a zašlite spolu s reklamačným protokolom

HR>Čišćenje se smije vršiti samo krpom ili blago navlaženim ručnikom. Nemojte koristiti sredstva za čišćenje.

Poštovani kupče, ako tijekom sastavljanja nađete oštećeni dio ili dio koji nedostaje, molimo da dostavite njegov alfanumerički kod ili ga označite u priručniku za sastavljanje i pošaljite ga zajedno s protokolom reklamacije

SRB>Чишћење треба вршити само крпом или благо влажним пешкиром.Немојте користити средства за чишћење.

Поштовани купче, ако током монтаже нађете оштећен или недостаје део, наведите његов алфанумерички код или га означите у приручнику за монтажу и пошаљите га заједно са рекламационим протоколом

I>La pulizia deve essere effettuata esclusivamente con un panno o un asciugamano leggermente inumidito.
Non utilizzare detergenti per sgrassare











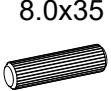

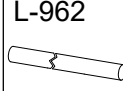

Gentile cliente, se durante il montaggio riscontri danni o parti mancanti, ti preghiamo di fornire il suo codice alfanumerico o segnarlo sulle istruzioni di montaggio e inviarlo insieme al rapporto di reclamo.

E>La limpieza sólo debe realizarse con un paño o toalla ligeramente humedecida.
No utilice agentes de limpieza para fregar.

Estimado cliente, si durante el montaje encuentra daños o faltan piezas, por favor proporcione su código alfanumérico o márkuelo en las instrucciones de montaje y envíelo junto con el informe de reclamación

Karta servisowa /Service Karte /Service card /Service kaart /Carte de service/ služební karta/služobný preukaz/servisna kartica/сервисна картица /Carta di servizio /Tarjeta de servicio

**AKCESORIA / ZUBEHÖR / ACCESSORIES / ACCESSOIRES / ACCESSOIRES / PŘÍSLUŠENSTVÍ / DOPLNKY / PRIBOR / ПРИБОР
ACCESSORI / ACCESORIOS**

 8.0x35 D	 A	 B	 X	 Ø3.5x16 H	 L1	 GW	 L-962 V1
16	16	16	16	18	9	70	1
 M	 Ø4.0x25 P	 N	 L-965 Y	 Z	 ALICANTE F4		 MARBELLA F3
6	12	2	4	6	1	1	

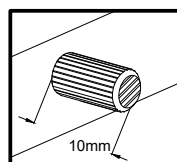
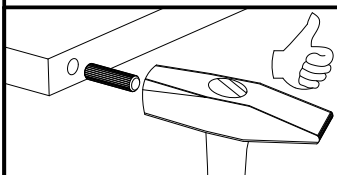
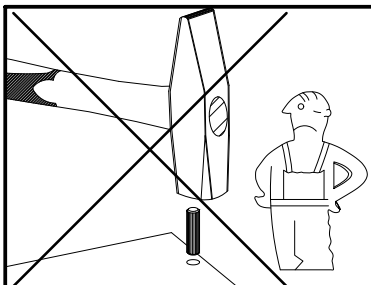

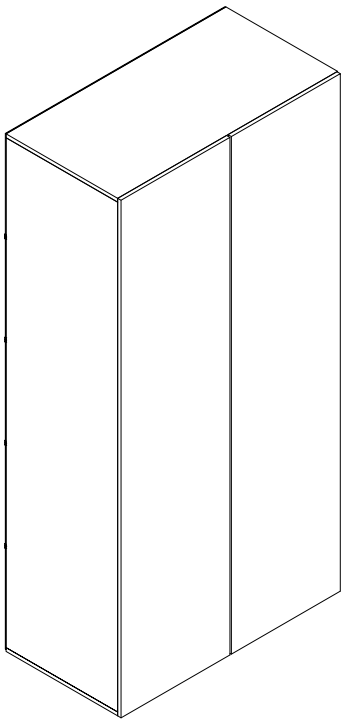

1.	1	1002	501	16
2.	1	1002	501	16
3.	1	1968	500	16
4.	1	1968	500	16
5.	5	995	398	3
6.	1	968	490	16
8.	2	1995	495	16

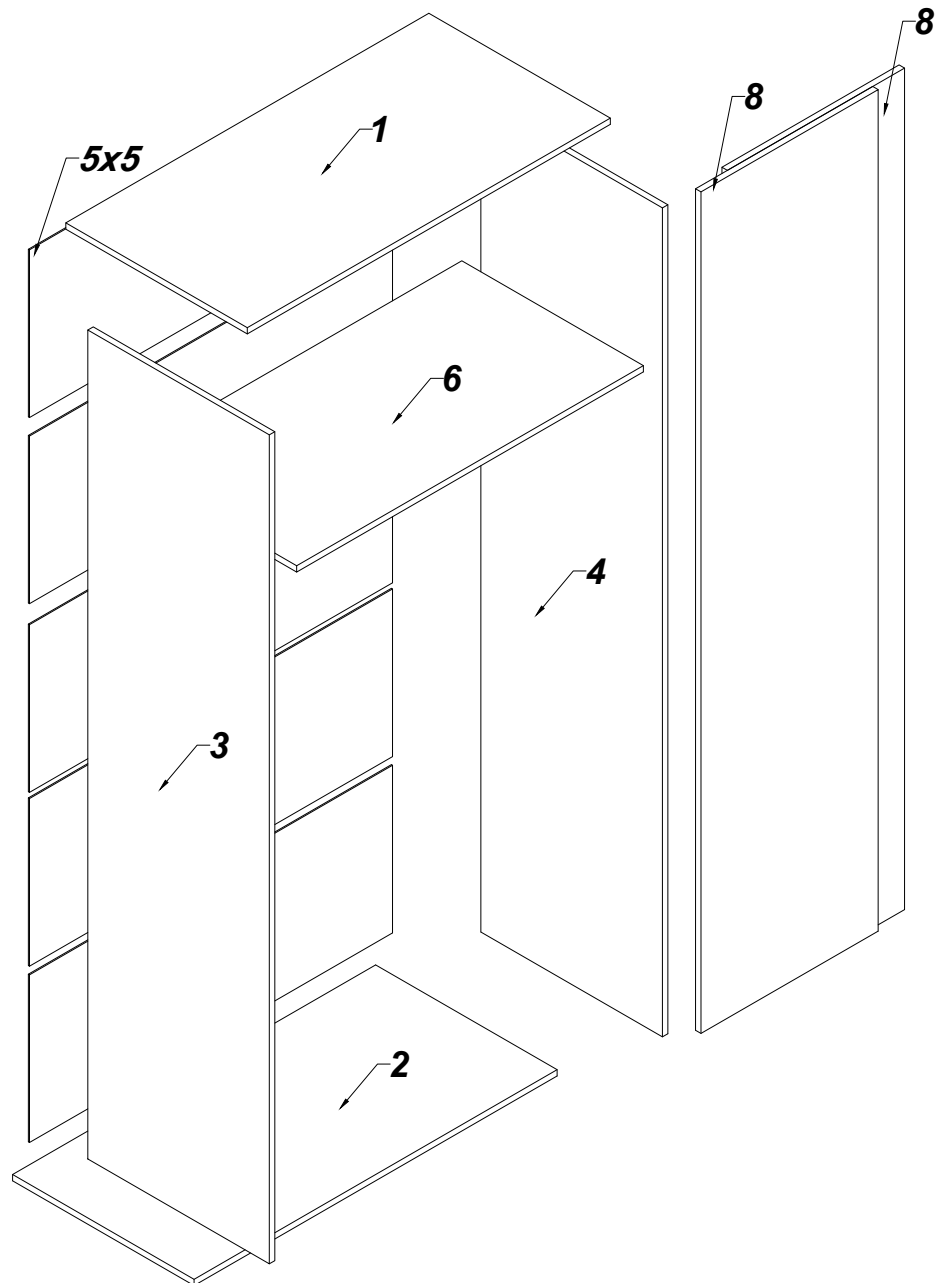

1

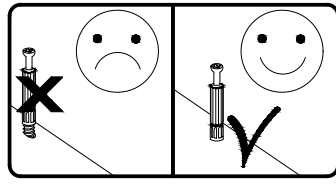
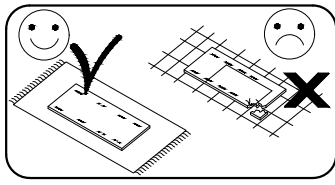
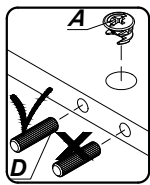

8.0x35 D	A	B
6	2	6
N	L1	Ø3.5x16 H
1	3	1

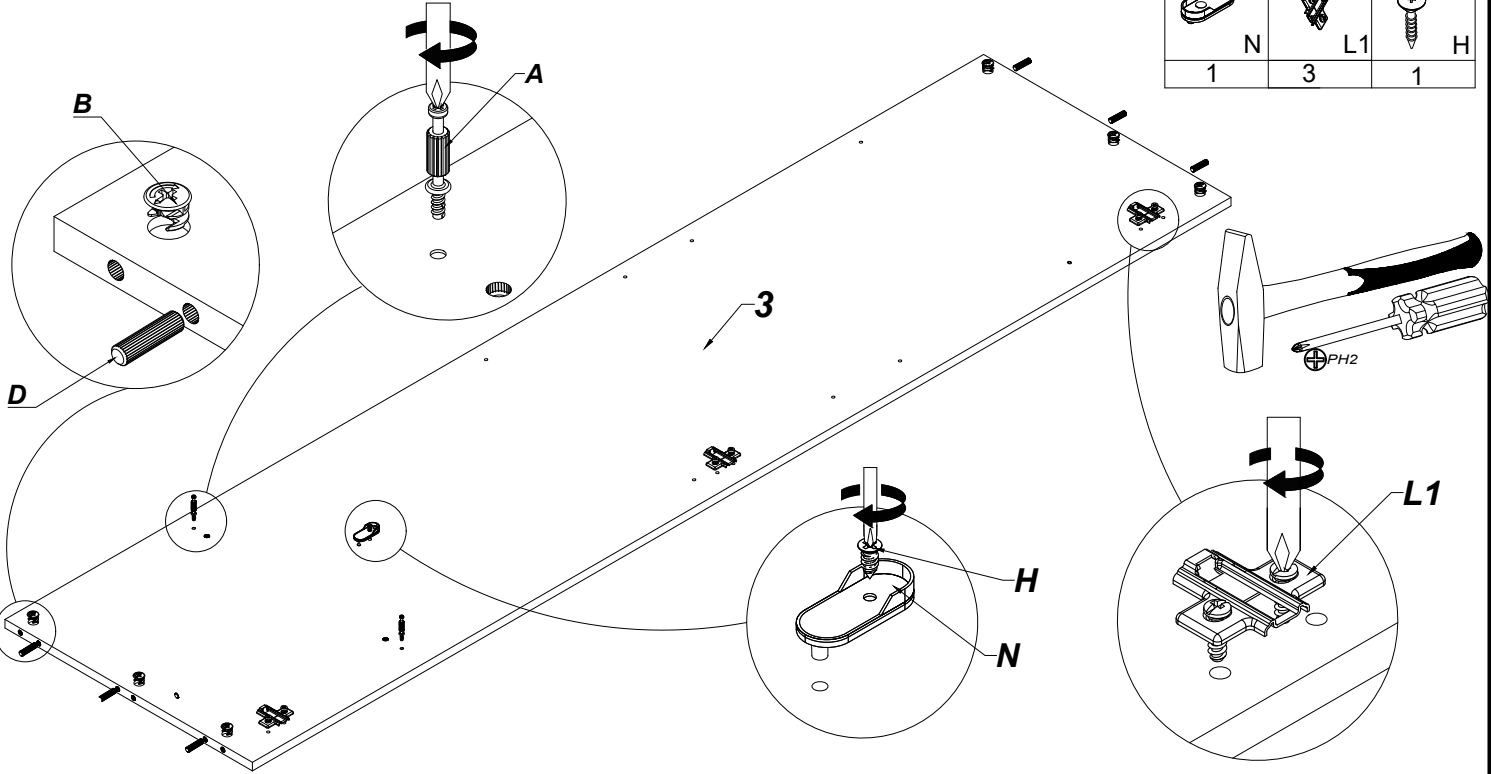

2

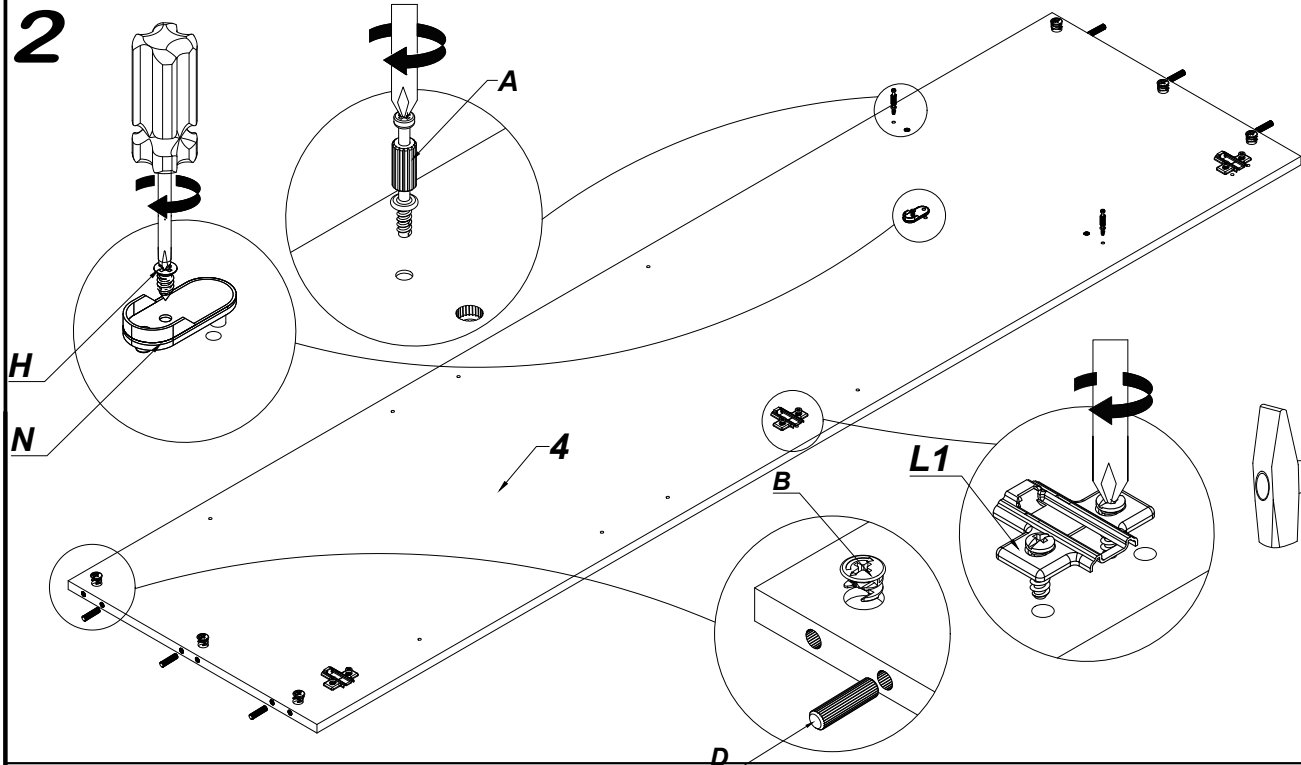

8.0x35 D	A
6	2
N	L1
1	3
B	Ø3.5x16 H
6	1

3

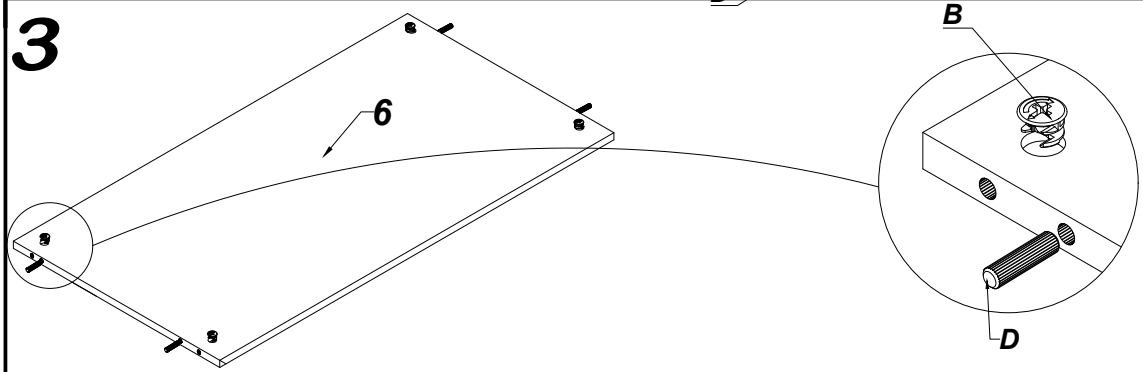

B	8.0x35 D
4	4

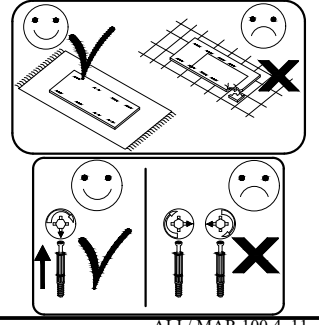

4

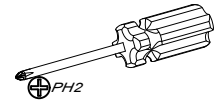
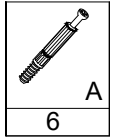
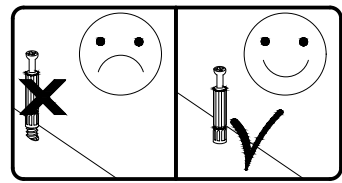
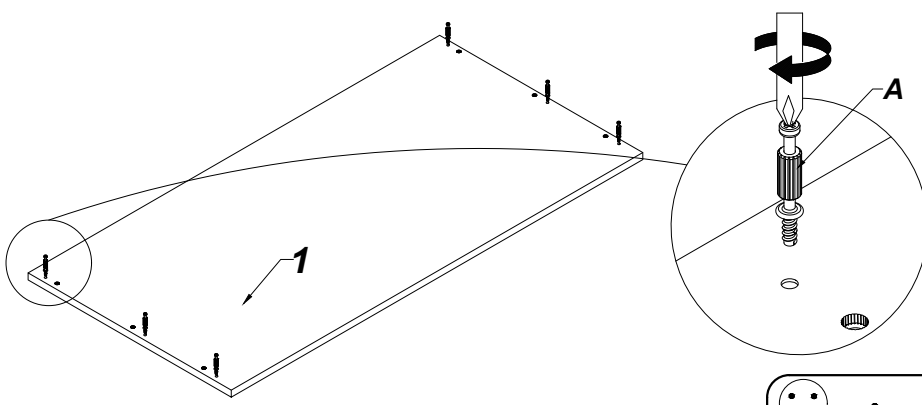

5

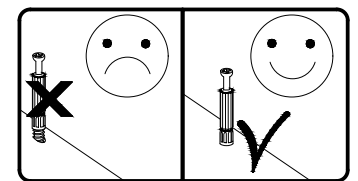
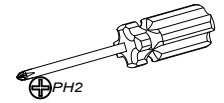
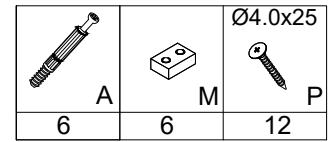
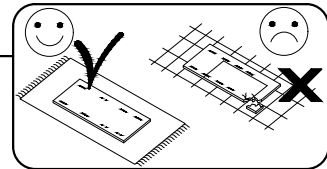
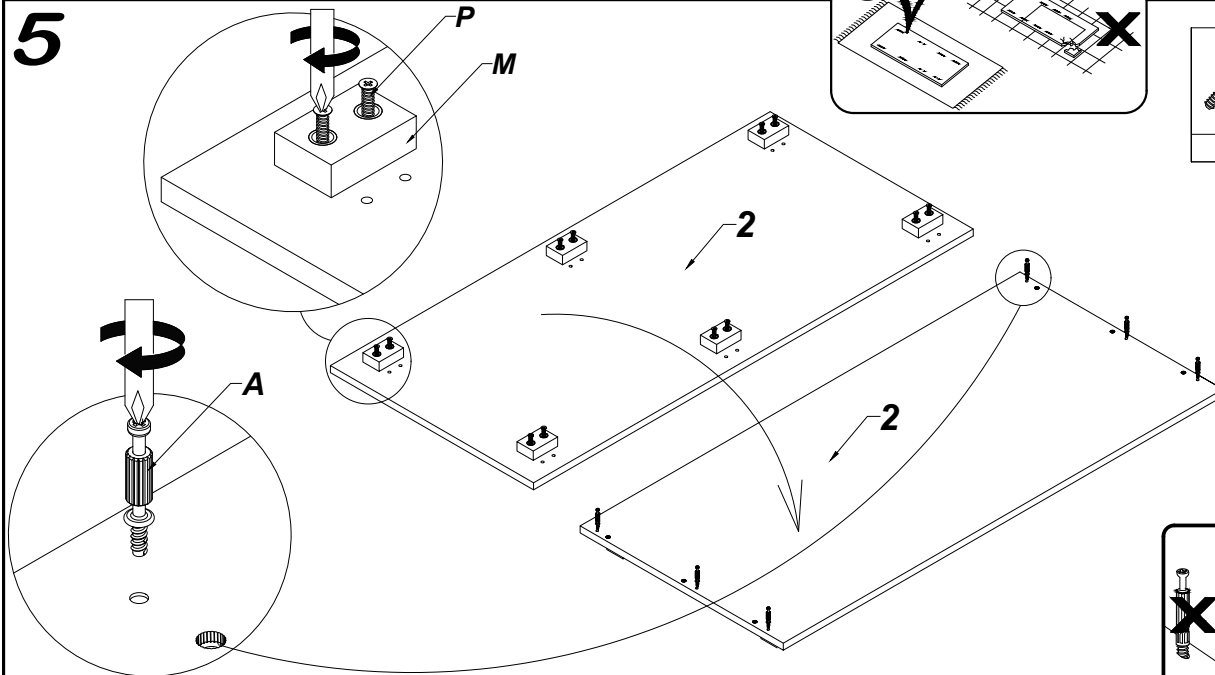

6

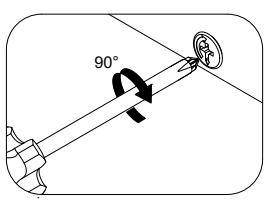
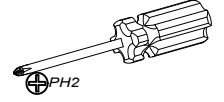
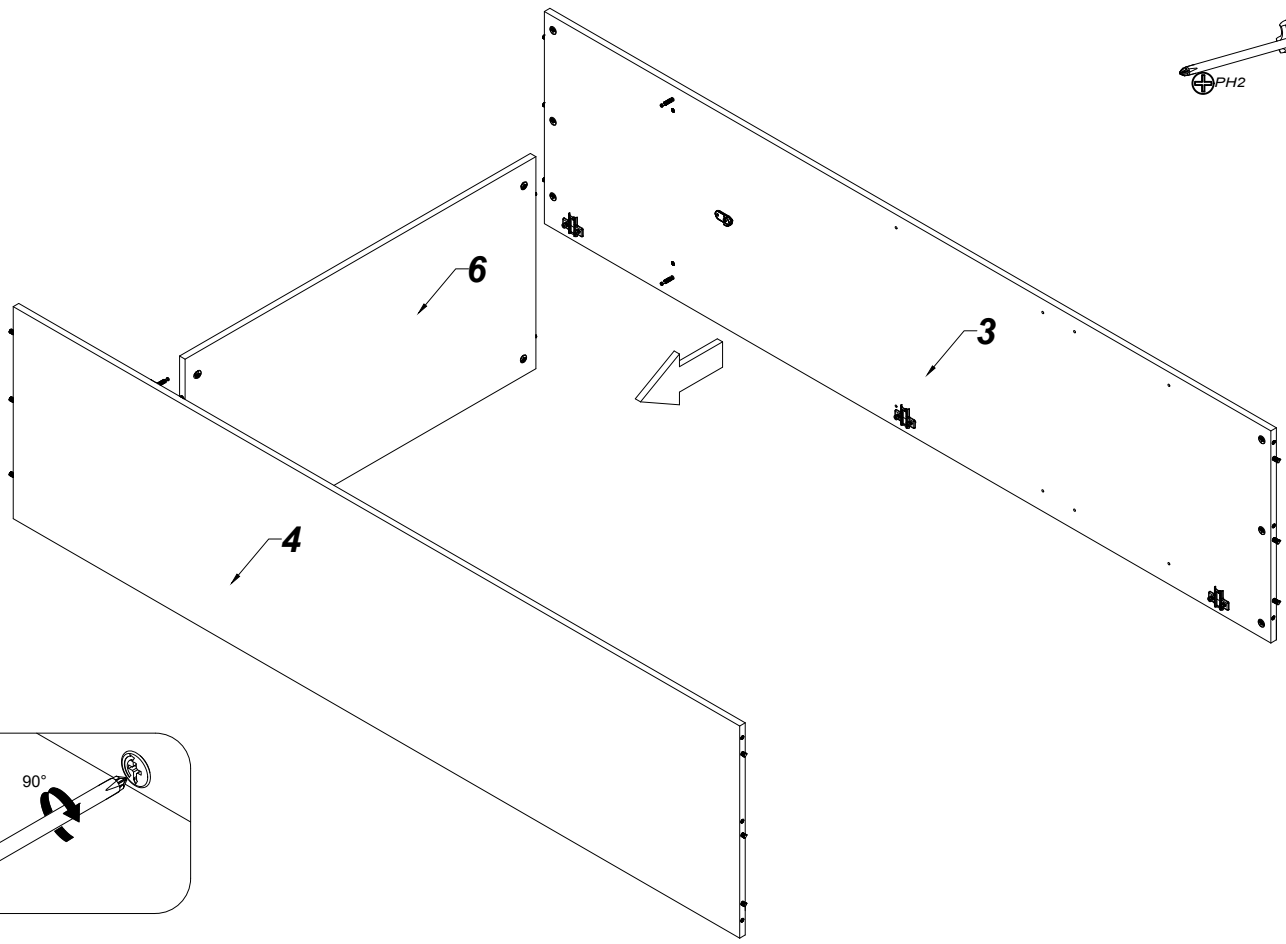

7

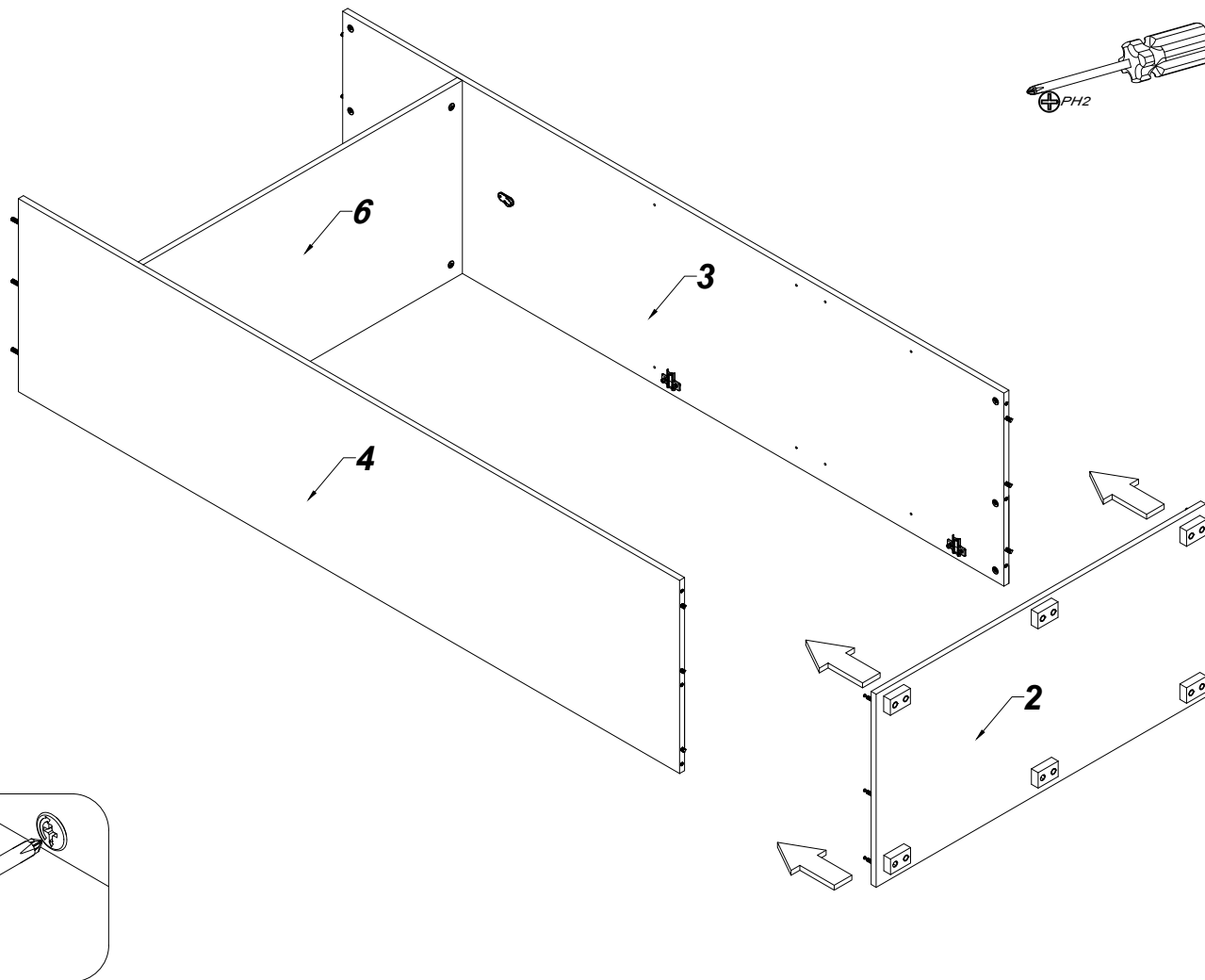
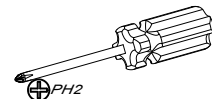

8

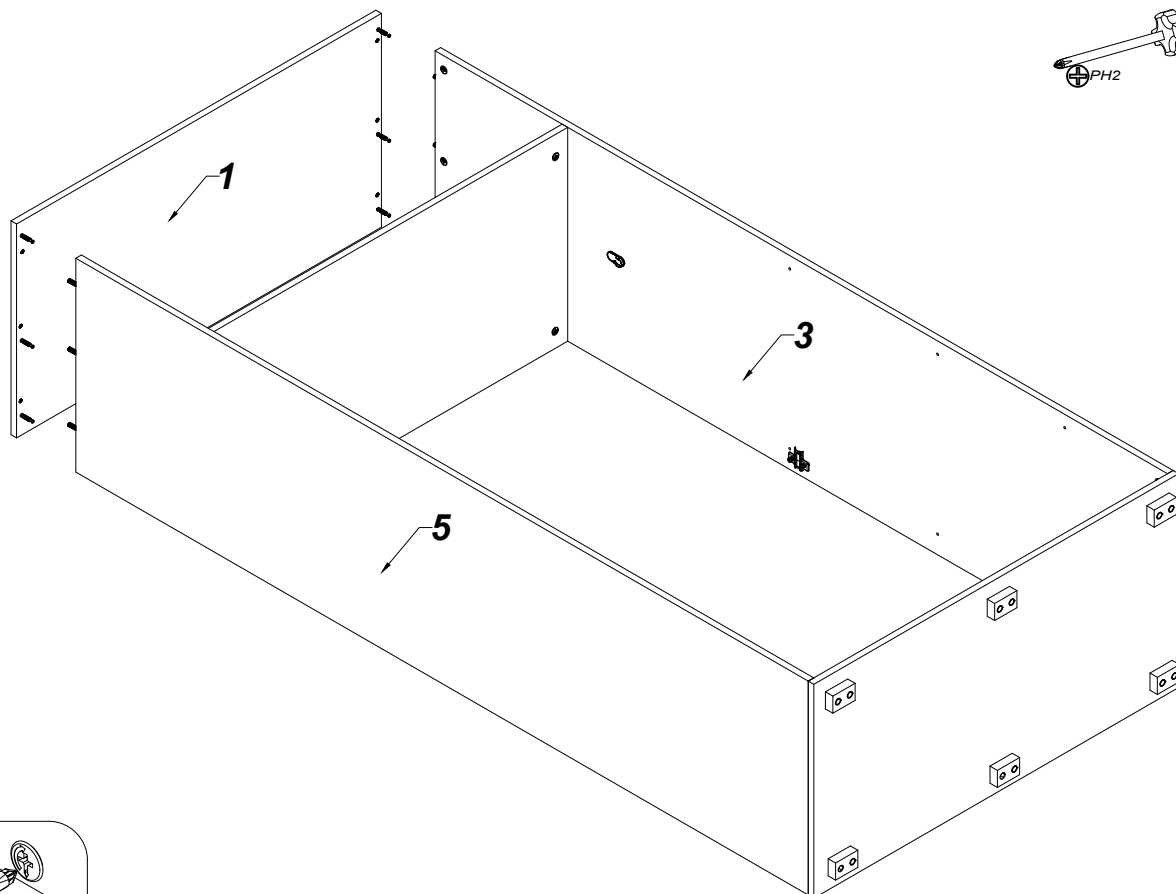
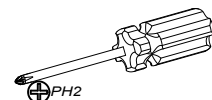

9

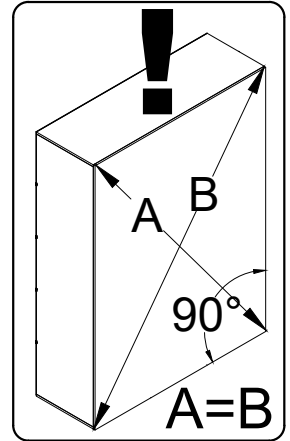
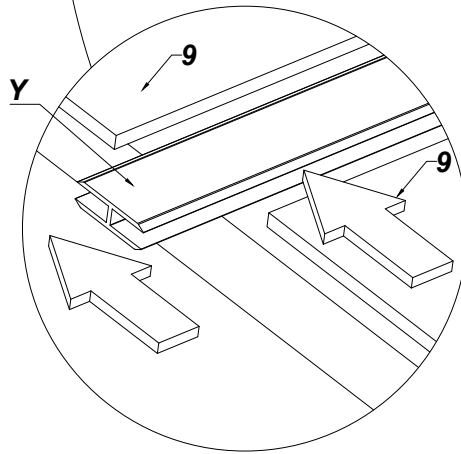
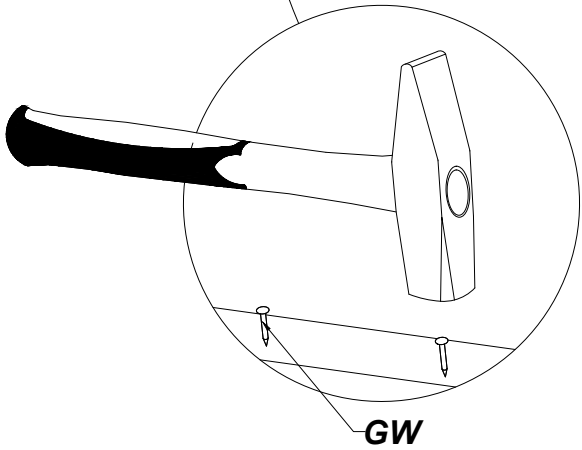
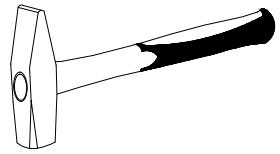
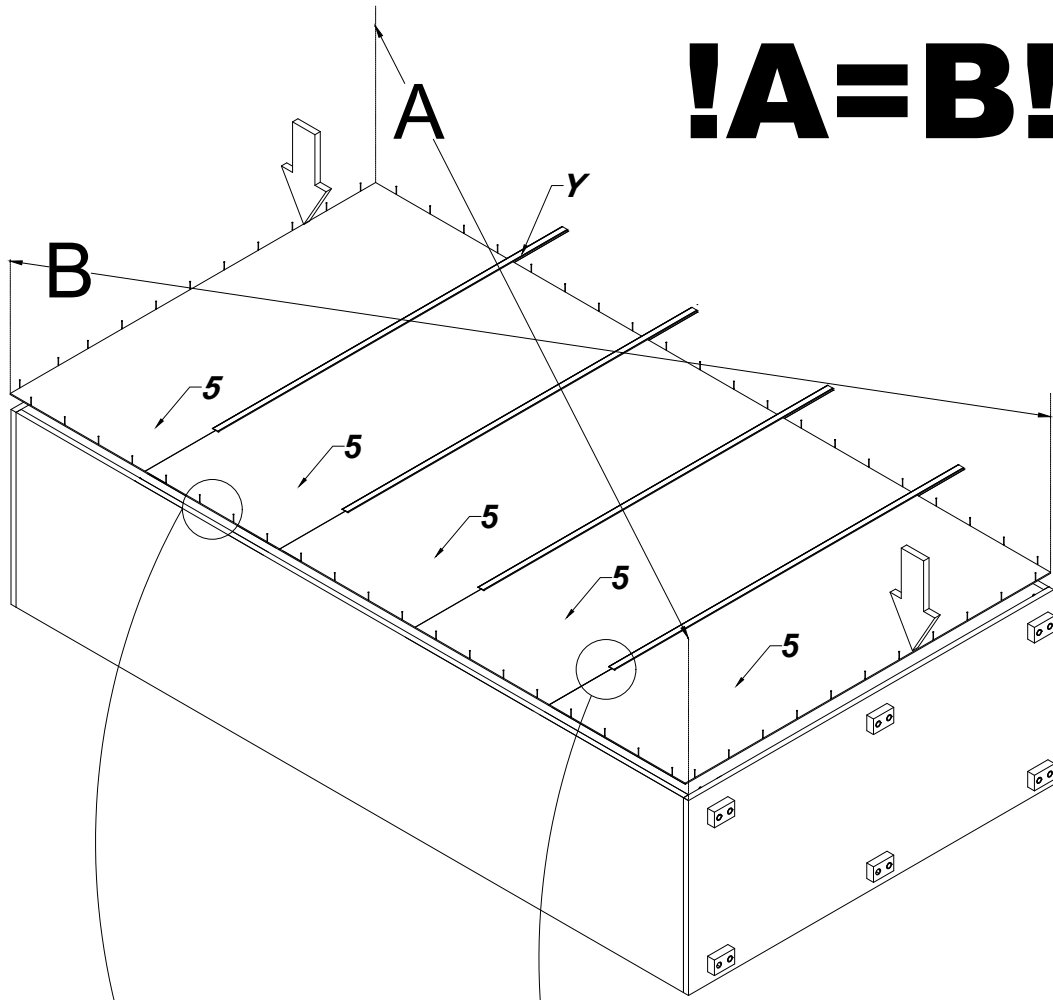

!A=B!

	L-965
GW	Y
70	4

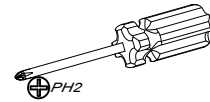
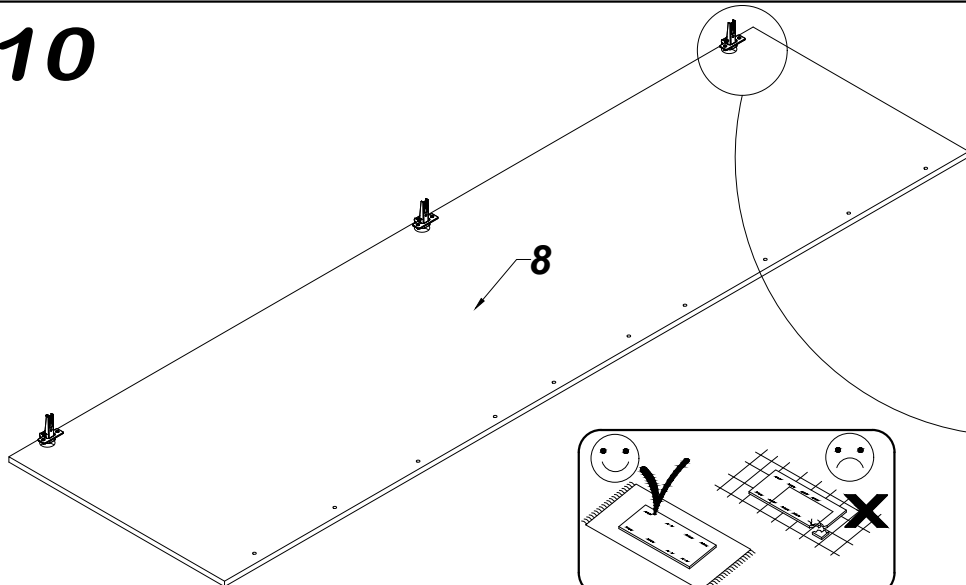

10



"0"	Ø3.5x16
	
Z	H
6	12

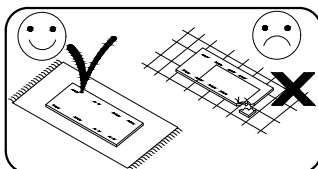
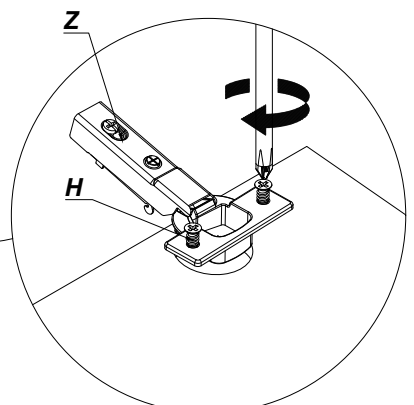

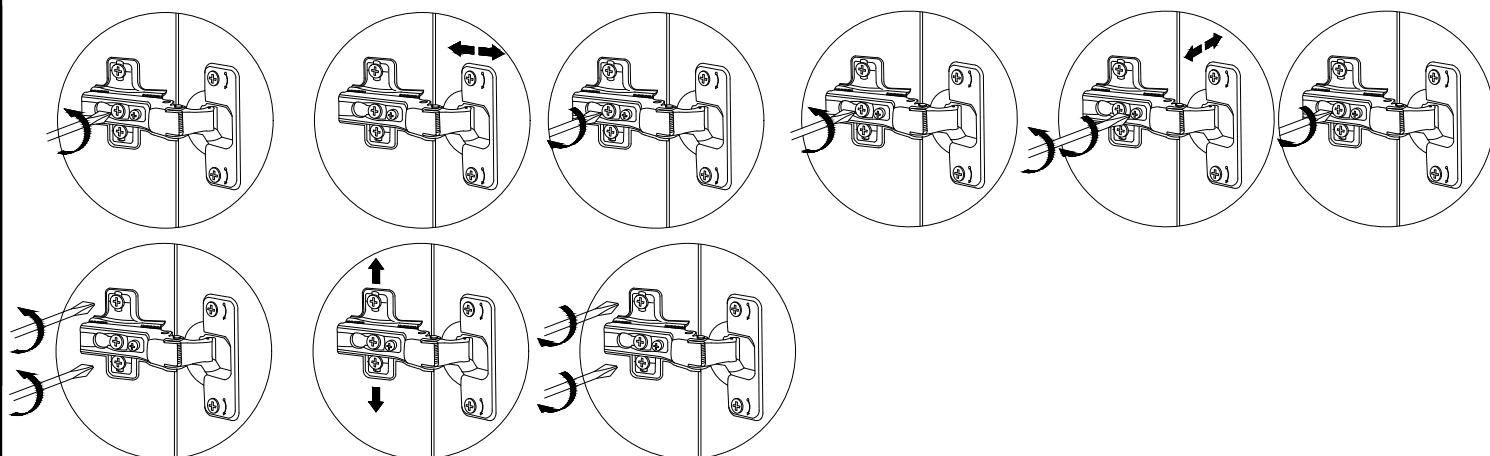
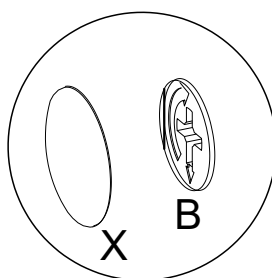
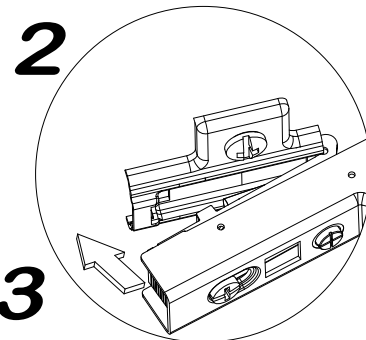
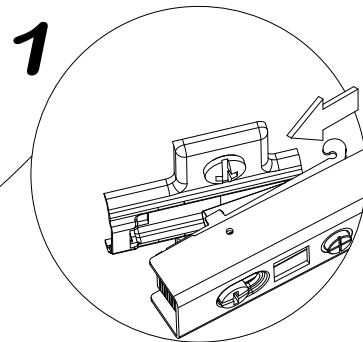
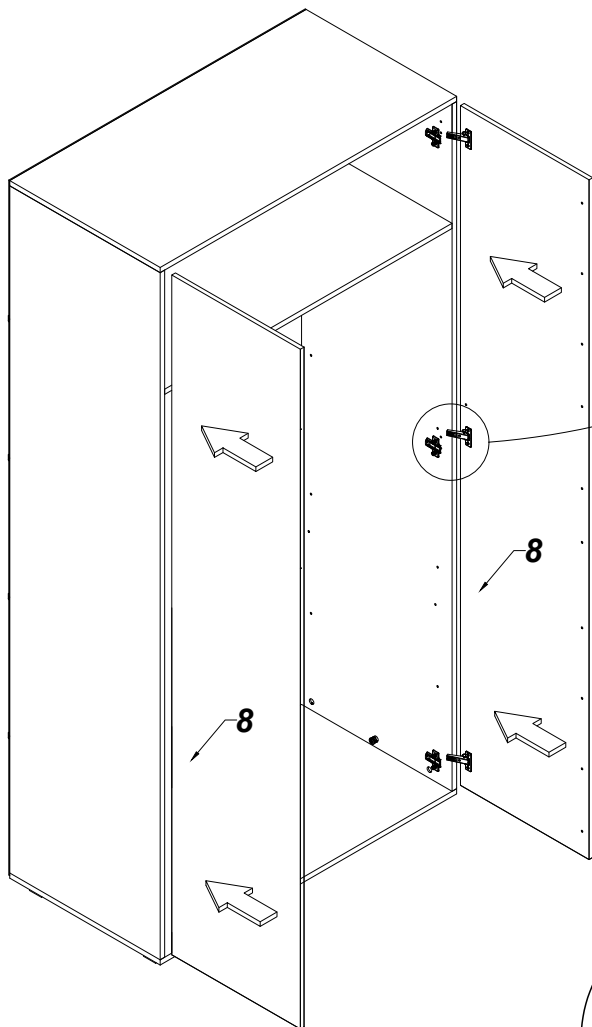
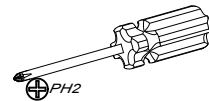

ALICANTE

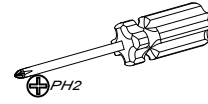

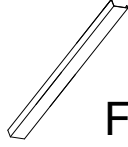
ALICANTE	
	F4
1	

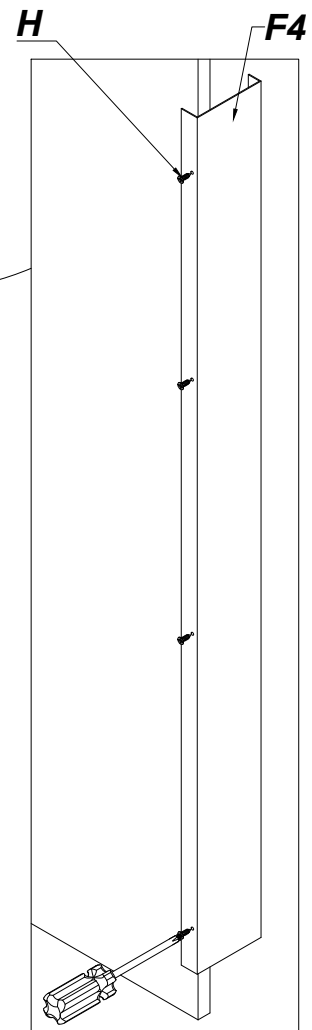
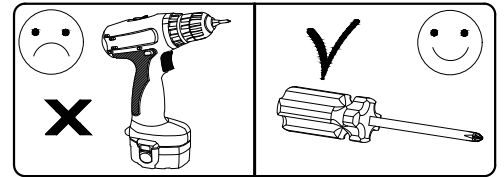
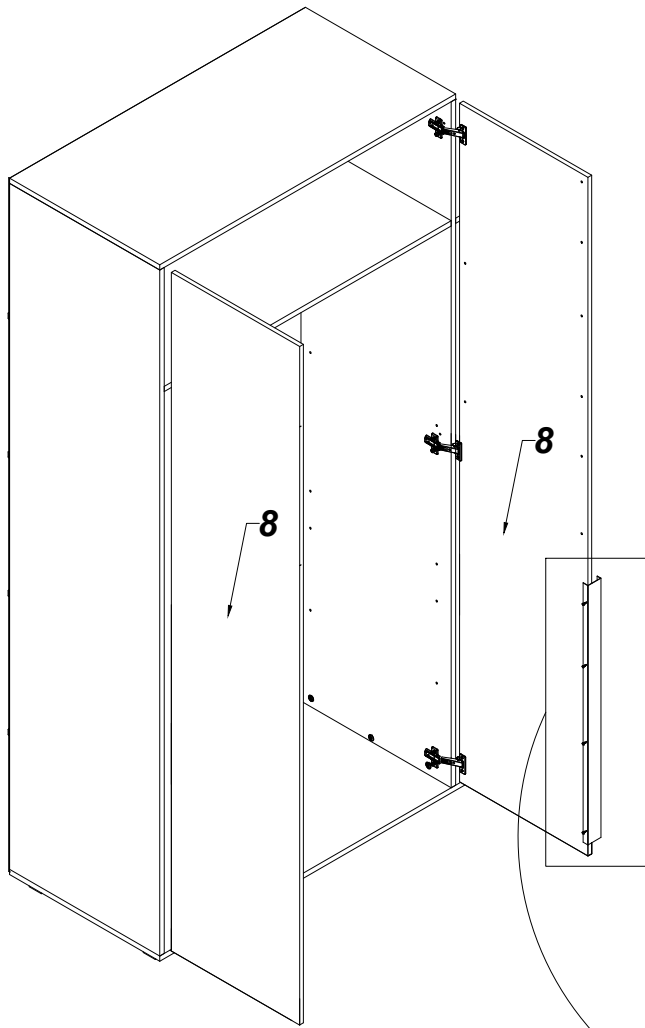

MARBELLA

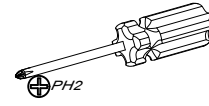

MARBELLA



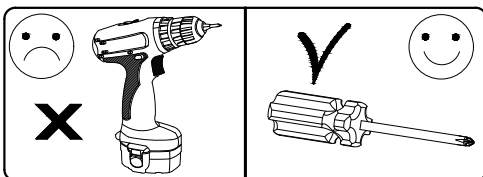
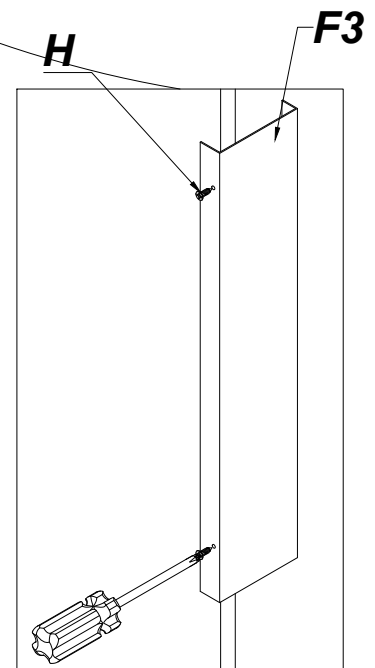
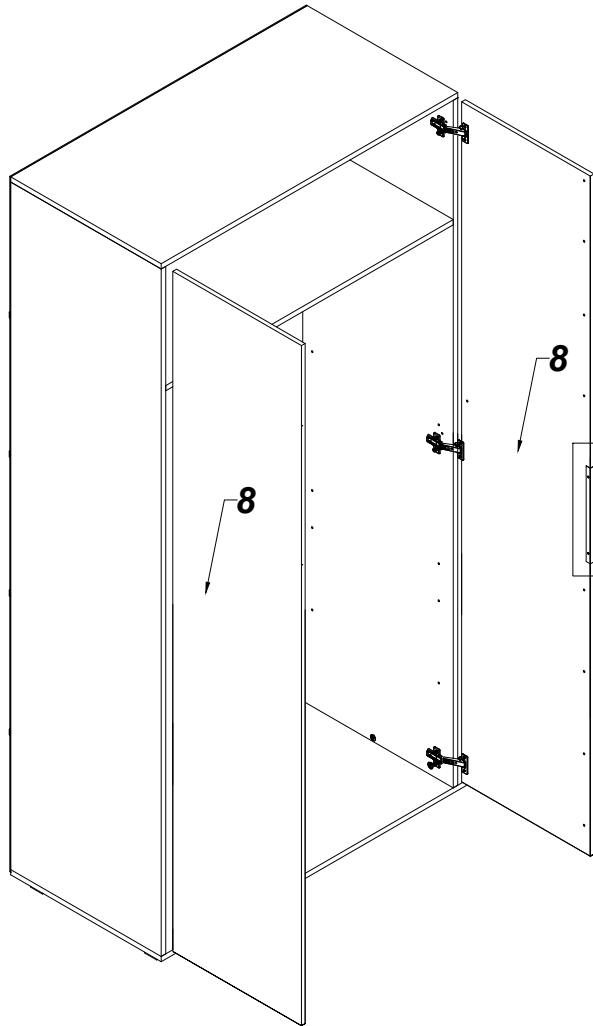

F3

1

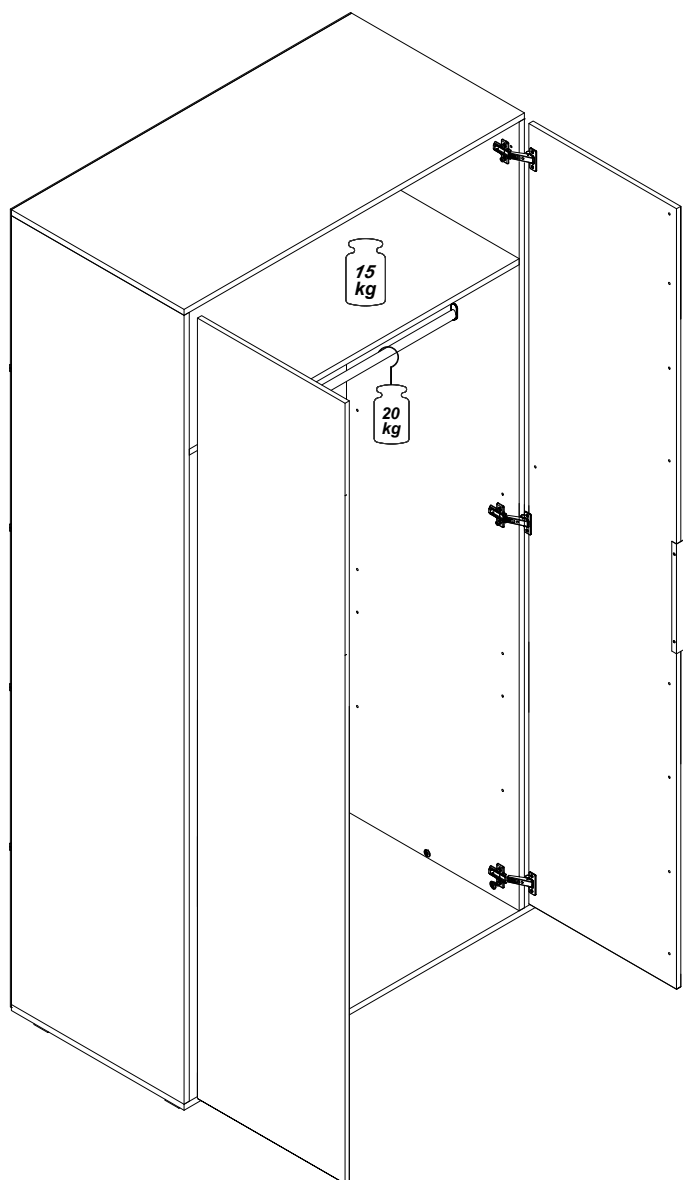
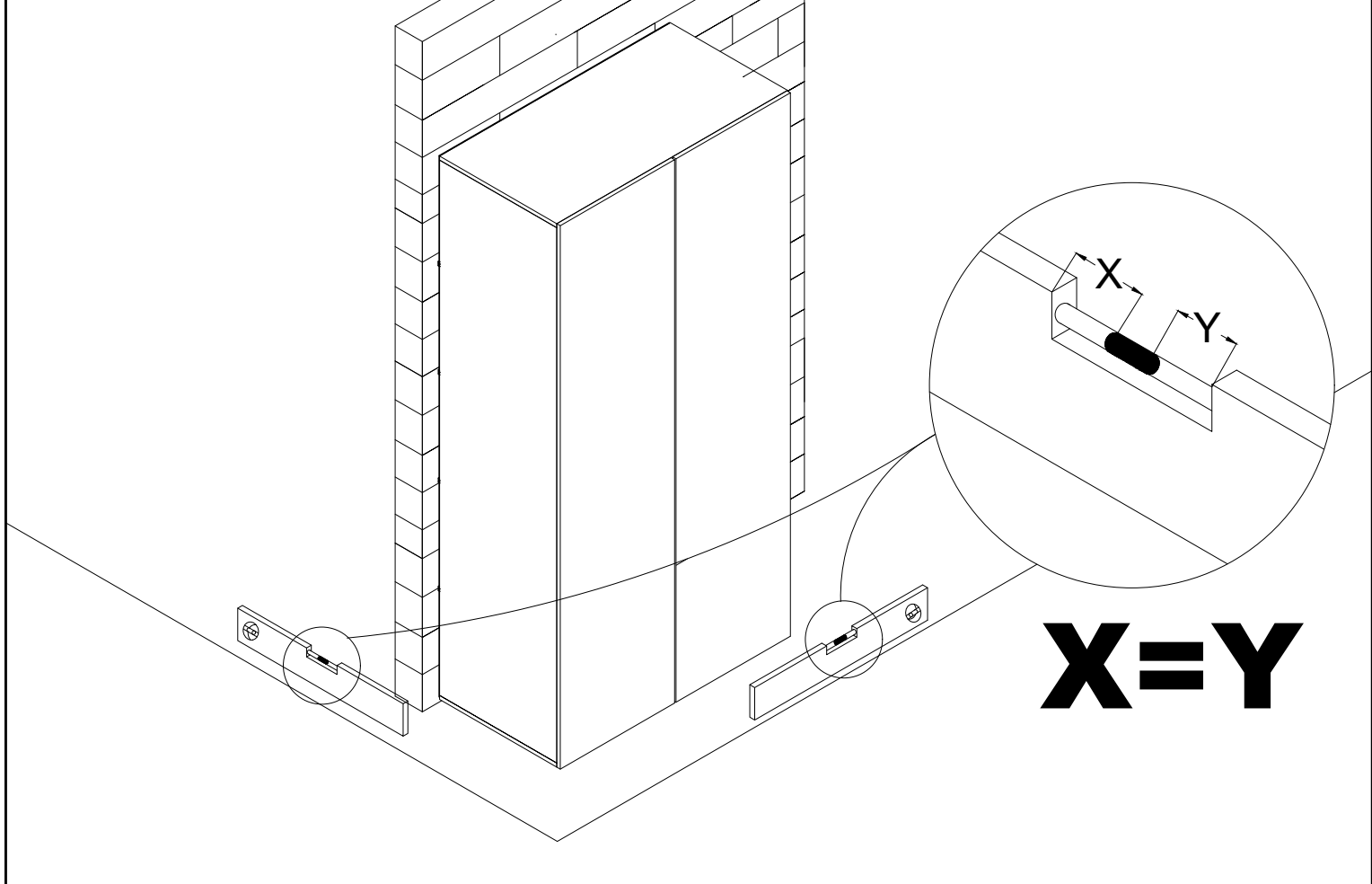

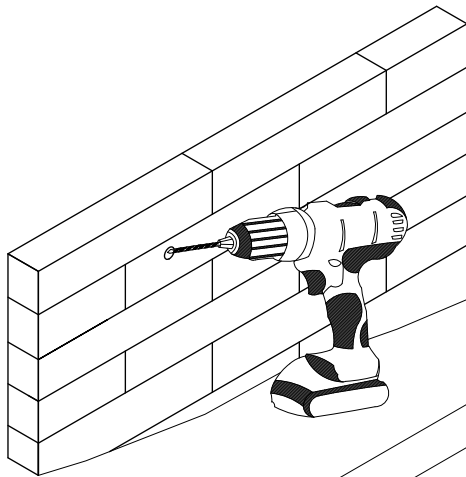

1

3.5x16		
	H	MS1
	1	1

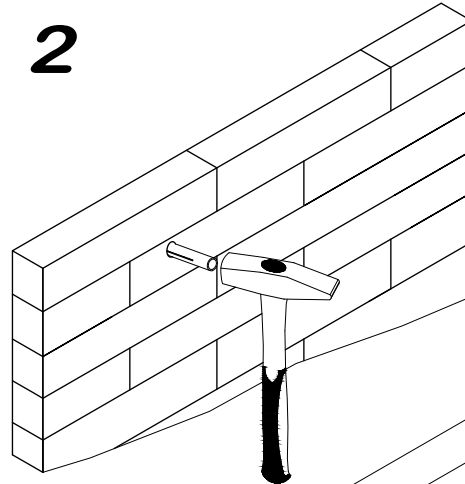
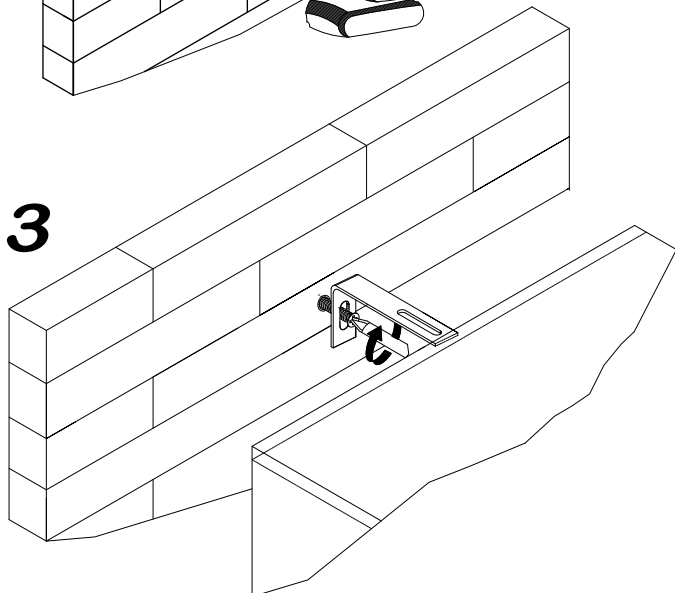
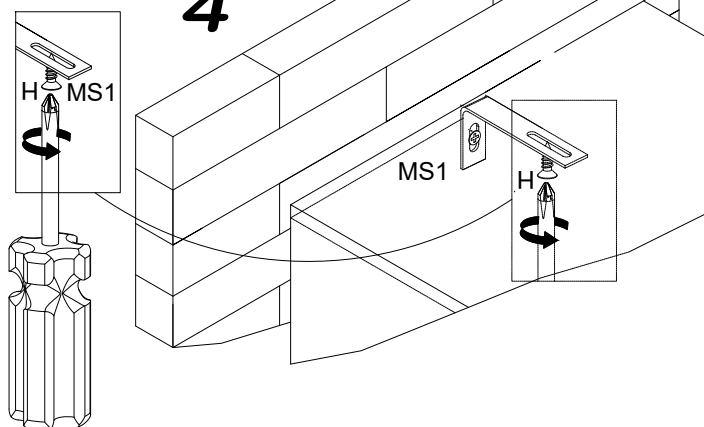
2**3****4**

!!! Kolek montażowy należy dobrać do odpowiedniego rodzaju ściany - do zakupienia we własnym zakresie !!!

Przy montażu artykułu na ścianie należy zastosować odpowiednie do niej zamocowania. W razie wątpliwości prosimy zasięgnąć porady fachowca.

PL Uwaga: Mocowanie mebla do ściany mogą przeprowadzić wyłącznie wykwalifikowane osoby, z uwagi na zastosowanie odpowiednio dopasowanych kołków do rodzaju ściany.

!!! Der Befestigungsstift sollte für den entsprechenden Wandtyp ausgewählt werden – er muss selbst erworben werden !!!

Für andere Wandaufbauten sind eventuell Spezialdübel und andere Schrauben notwendig. Ziehen Sie gegebenenfalls eine Fachkraft zurate.

D **Achtung:** Die Befestigung des Möbelstückes an der Wand muss von einer fachkundigen Person vorgenommen werden, da für die Montage an die Wand angepasste Dübel erforderlich sind.

!!! The mounting pin should be selected for the appropriate type of wall - to be purchased on your own !!!

Special dowels and other screws may be necessary for other wall constructions. If necessary, please consult a qualified professional.

GB **Attention:** A qualified professional is required when mounting furniture to the wall since dowels corresponding to the wall are required for this.

!!! La goupille de fixation doit être sélectionnée pour le type de mur approprié - elle doit être achetée séparément !!!

Pour les autres constructions de murs, il faut éventuellement des chevilles spéciales et d'autres vis. Faites-vous conseiller par un spécialiste.

F **Attention :** La fixation du meuble contre le mur doit être effectuée par une personne compétente car, pour le montage mural, il faut utiliser des chevilles adaptées.

!!! De bevestigingspin moet worden geselecteerd voor het juiste type muur - deze moet afzonderlijk worden aangeschaft !!!

Voor andere muurconstructies zijn eventueel speciale pluggen en andere schroeven noodzakelijk. Consulteer eventueel een vakman

NL **Opgelet:** een vakkundige persoon dient het meubelstuk aan de muur te bevestigen; voor de montage aan de muur zijn immers aangepaste pluggen vereist.

!!! Upevňovací trn by měl být vybrán pro příslušný typ stěny - je třeba jej zakoupit samostatně !!!

Pro jiné skladby stěn budou případně nutné speciální hmoždinky a jiné šrouby. Poradte se případně s odborníkem.

CZ **Pozor:** Montáž nábytku na stěnu musí provést odborník, protože k montáži na stěnu jsou zapotřebí upravené hmoždinky.

!!! Upevňovací kolík by mal byť vybraný pre príslušný typ steny - je potrebné ho zakúpiť samostatne !!!

Preiné steny sú potrebné príp. špeciálne hmoždinky a iné skrutky. V prípade potreby sa poradte s odborníkom.

SK **Pozor:** Upevnenie nábytku na stenu musí vykonať odborník, nakoľko sú pre montáž na stenu potrebné vhodné hmoždinky.

!!! Zatik za pričvršćivanje treba odabrati za odgovarajuću vrstu zida - treba ga kupiti zasebno !!!

Kada montirate proizvod na zid, koristite odgovarajuće pričvršćne elemente. Ako ste u nedoumici, obratite se stručnjaku.

HR Napomena: Pričvršćivanje namještaja na zid smiju izvoditi samo kvalificirane osobe, zbog upotrebe pravilno usklađenih tipli s vrstom zida.

!!! Пин за причвршћивање треба одабрати за одговарајући тип зида - треба га купити засебно!!!

Када монтирате артикал на зид, користите одговарајуће причвршћиваче. Ако сте у недоумици, обратите се професионалцу.

SRB Напомена: Причвршћивање намештаја на зид смеју да обављају само квалификоване особе, због употребе типлова који су правилно прилагођени типу зида

I

Quando si monta l'articolo a parete utilizzare elementi di fissaggio adeguati. In caso di dubbi, chiedere una consulenza professionale.

Nota: Il mobile può essere fissato al muro solo da personale qualificato, grazie all'utilizzo di perni opportunamente adeguati al tipo di muro.

E

Al montar el artículo en la pared, utilice sujetadores adecuados. En caso de duda, busque asesoramiento profesional.

Nota: Los muebles sólo pueden ser fijados a la pared por personas calificadas, debido al uso de pasadores adecuados al tipo de pared.