

150 min

TYP 840

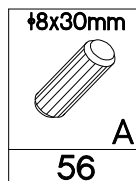
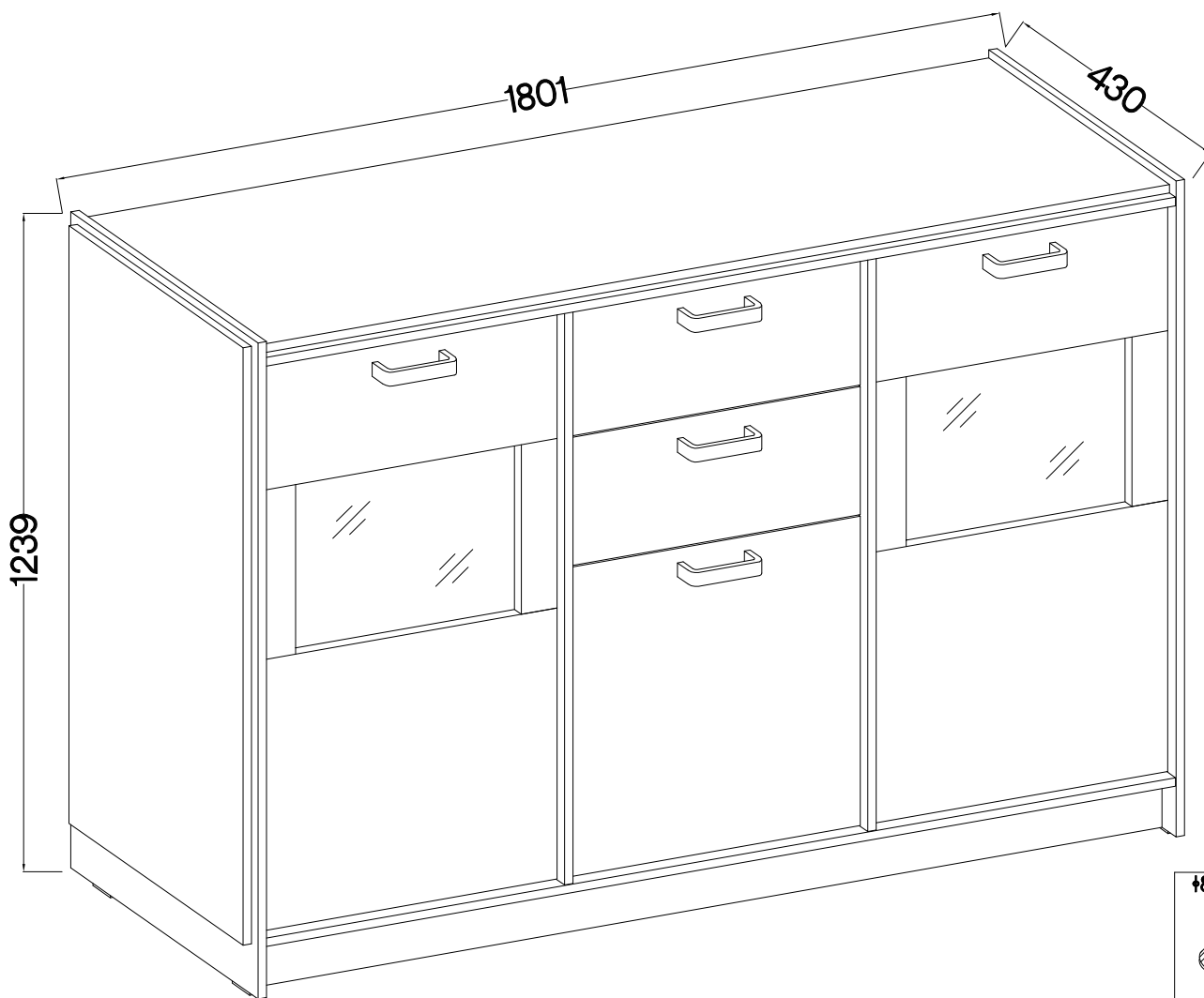
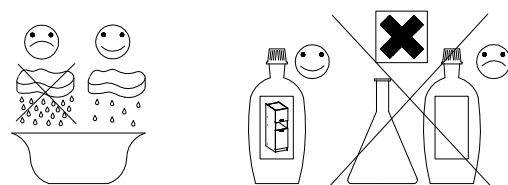

+8x60mm A2	+8x20mm A4	6,4 x 50mm B	+6x42mm B2	+15/12mm C	+12/10mm C5	L=20mm D2	L=40mm D12	cza. E	art. E	+35mm E5
16	4	4	4	48	4	36	8	22	22	6
6.5x48x16 F2	+15x5mm F4	+35/16mm HG2	27/310mm I4	+5/16mm J3	J8	L	L2	L9	+6,3x13mm M2	O
4	2	8	2	4	12	22	16	2	8	1
+10x50mm O7	0,05 O11	+4.0x16mm P1	+3.5x13mm P5	+3.0x20mm P7	+3.0x16mm P11	+3.5x25mm BLACK P25	L=128mm S	T3	M4x22mm U	M4x9mm U1
2	1	2	18	44	12	20	5	1	10	4

ISM-KIA-010

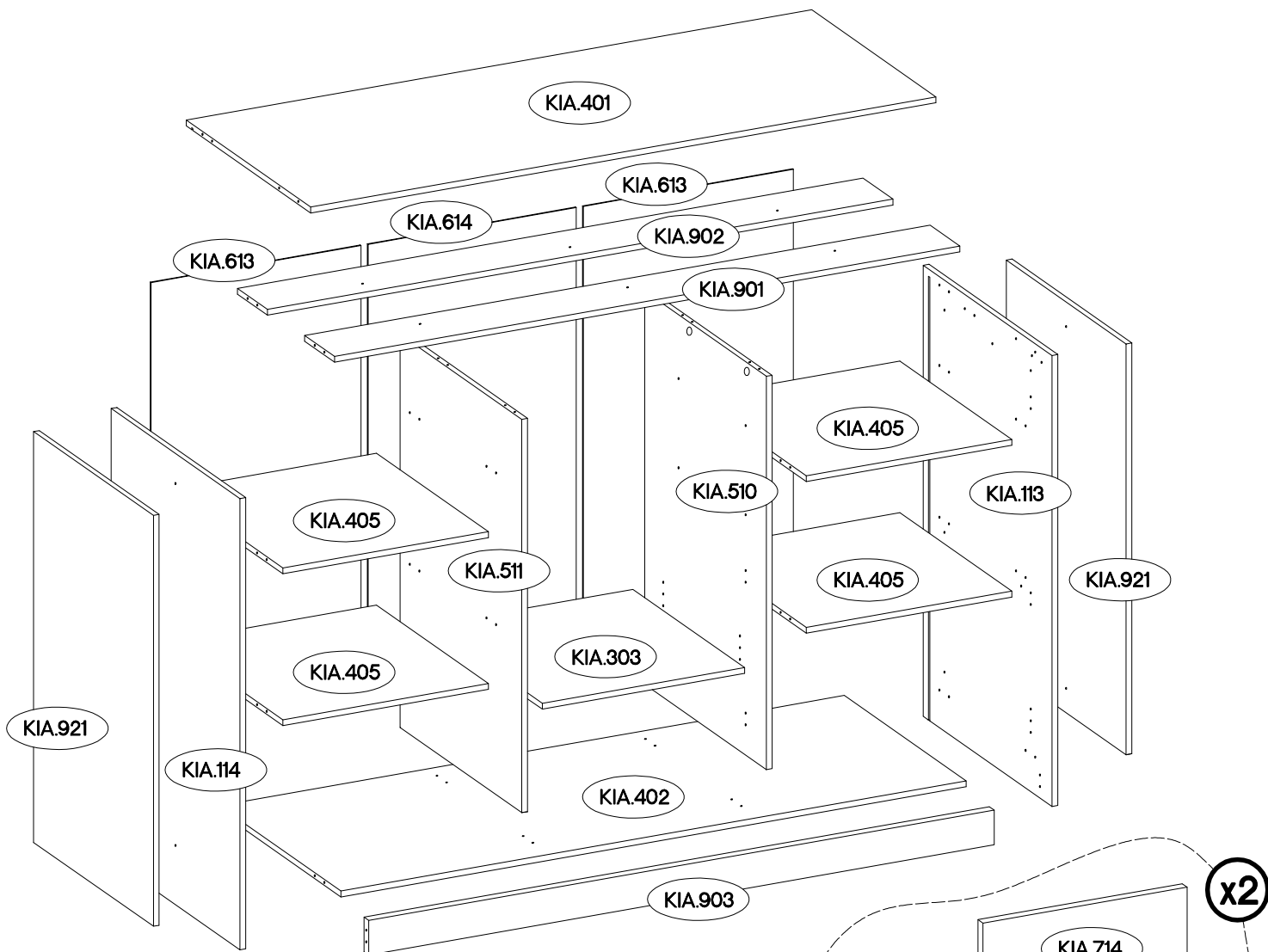

KIA.303  
KIA.405

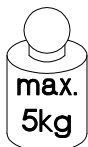

KIA.603

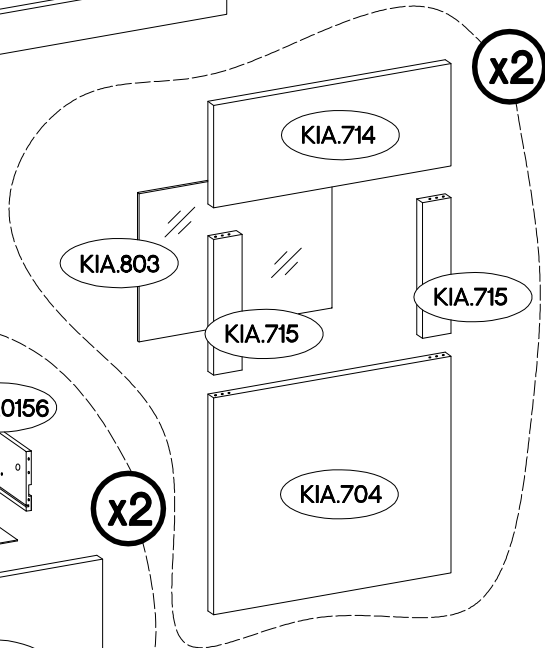
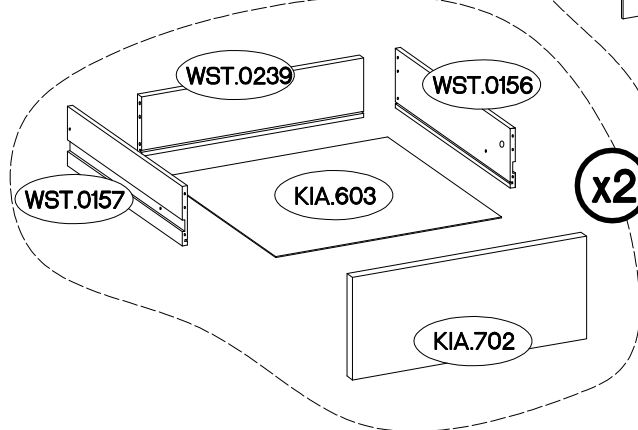

Colli	Ersatzteil Nummer	Dimension
1/3	KIA.113	1234x430x16
	KIA.114	1234x430x16
	KIA.510	1076x406x16
	KIA.511	1076x406x16
	KIA.715 x4	319x68x16
	KIA.921 x2	1124x400x16



Colli	Ersatzteil Nummer	Dimension
2/3	KIA.603 x2	540x327x2,5
	KIA.613 x2	1111x583x2,5
	KIA.614	1111x578x2,5
	KIA.702 x2	559x241x16
	KIA.704 x2	567x510x16
	KIA.713	559x582x16
	KIA.714 x2	567x241x16
	WST.0156 x2	330x140x12
	WST.0157 x2	330x140x12
WST.0239 x2	530x140x12	

Colli	Ersatzteil Nummer	Dimension
3/3	KIA.303	562x373x16
	KIA.401	1737x415x16
	KIA.402	1737x407x16
	KIA.405 x4	571x374x16
	KIA.901	1737x100x16
	KIA.902	1737x100x16
	KIA.903	1737x95x16
	KIA.803 x2	349x461x4

1

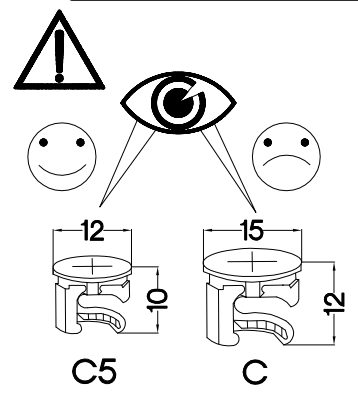
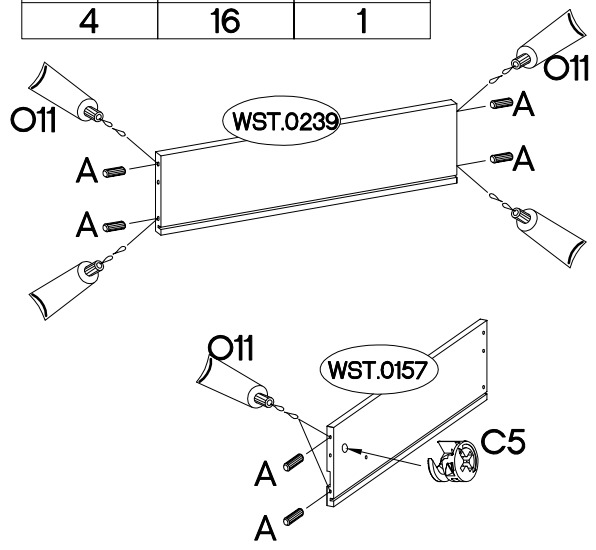
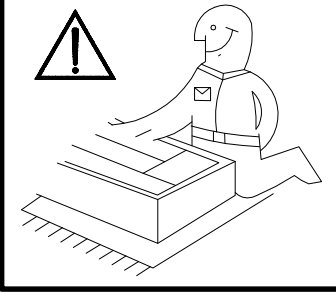

#12/10mm  C5 4	+8x30mm  A 16	0,05  Lein O11 1
---	--	---

x2



2

x2

+6x42mm  B2 4	0,05  Lein O11 1
---	--

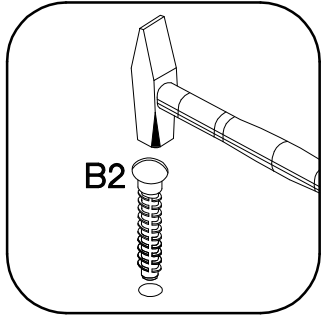
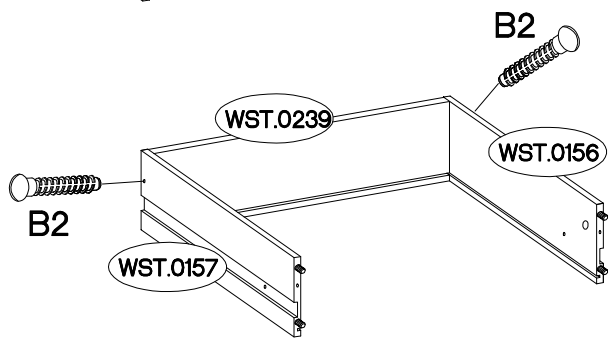
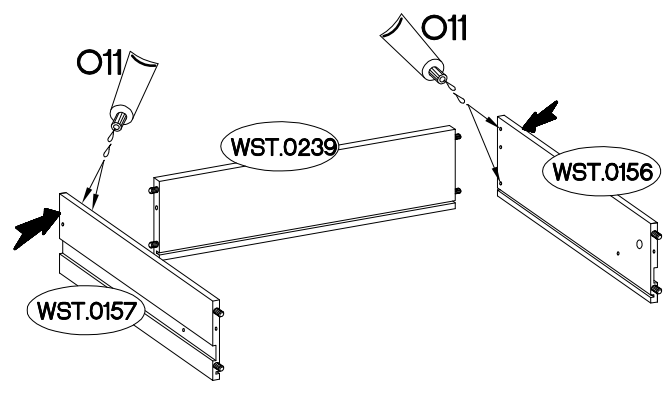

3

L=20mm  D2 4
--

x2

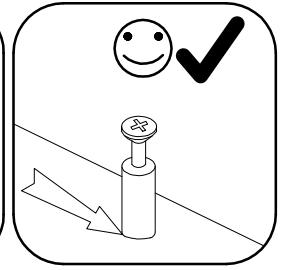
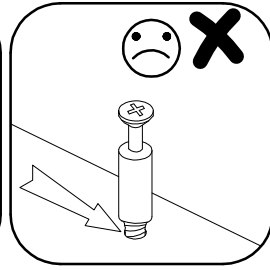
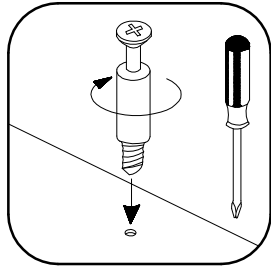
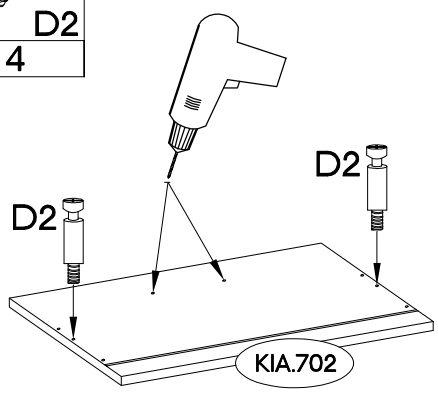
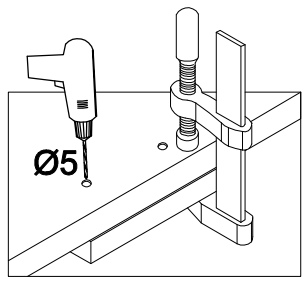
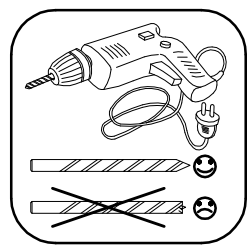

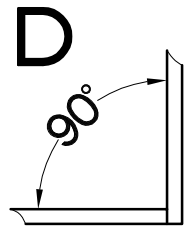
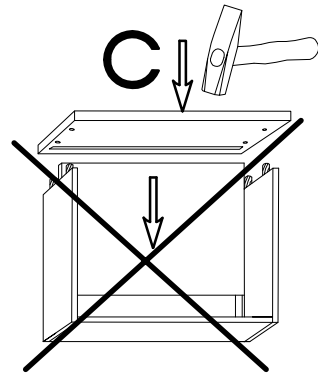
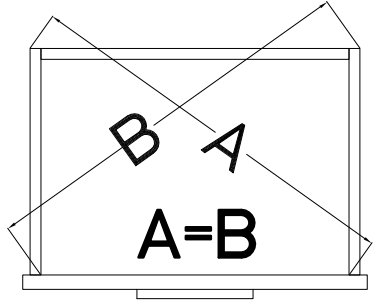
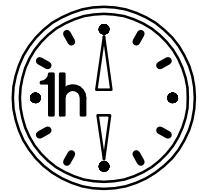
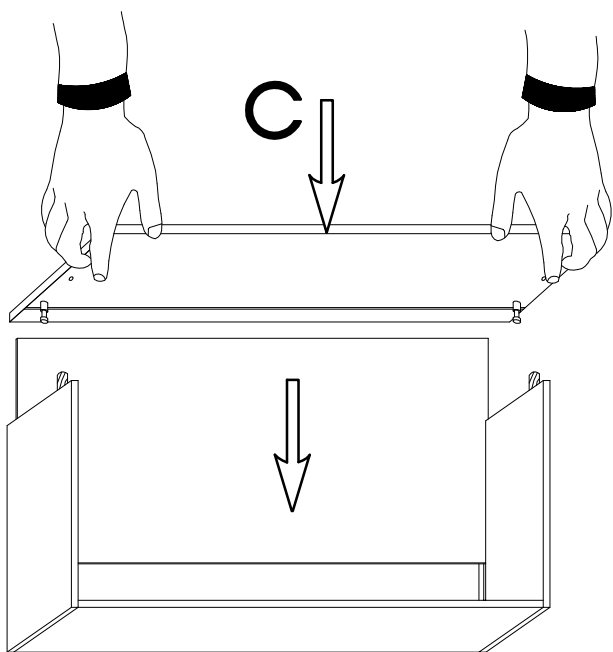
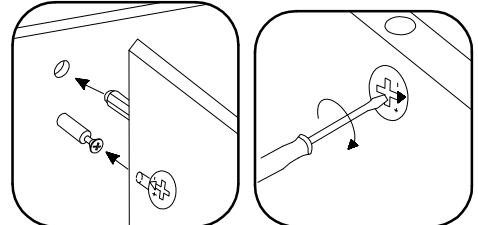
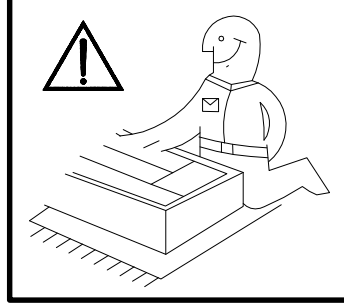
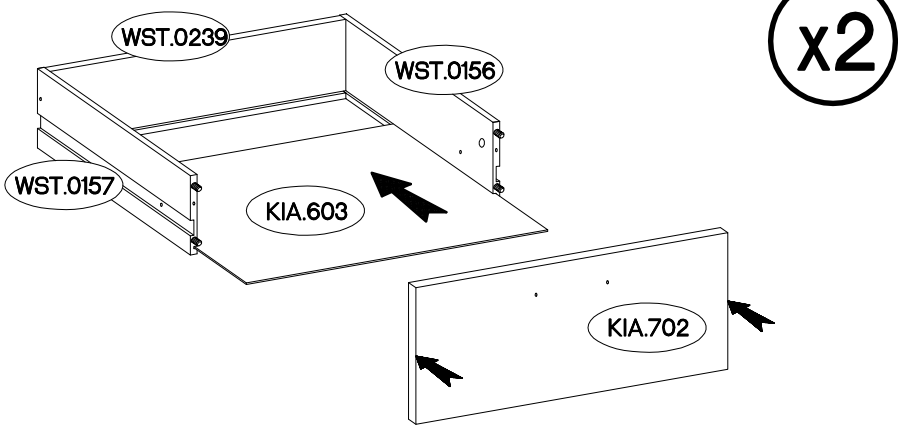

4

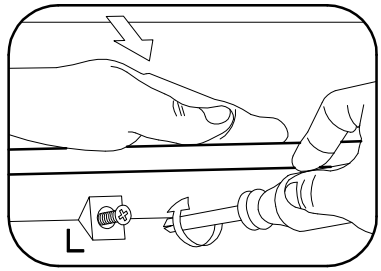
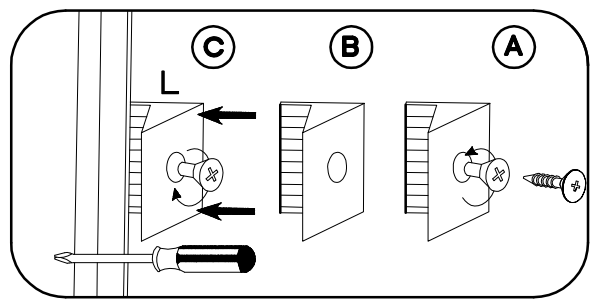
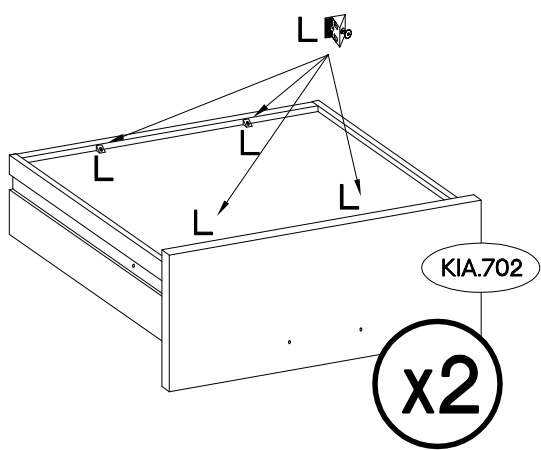
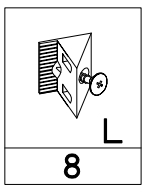

5



6



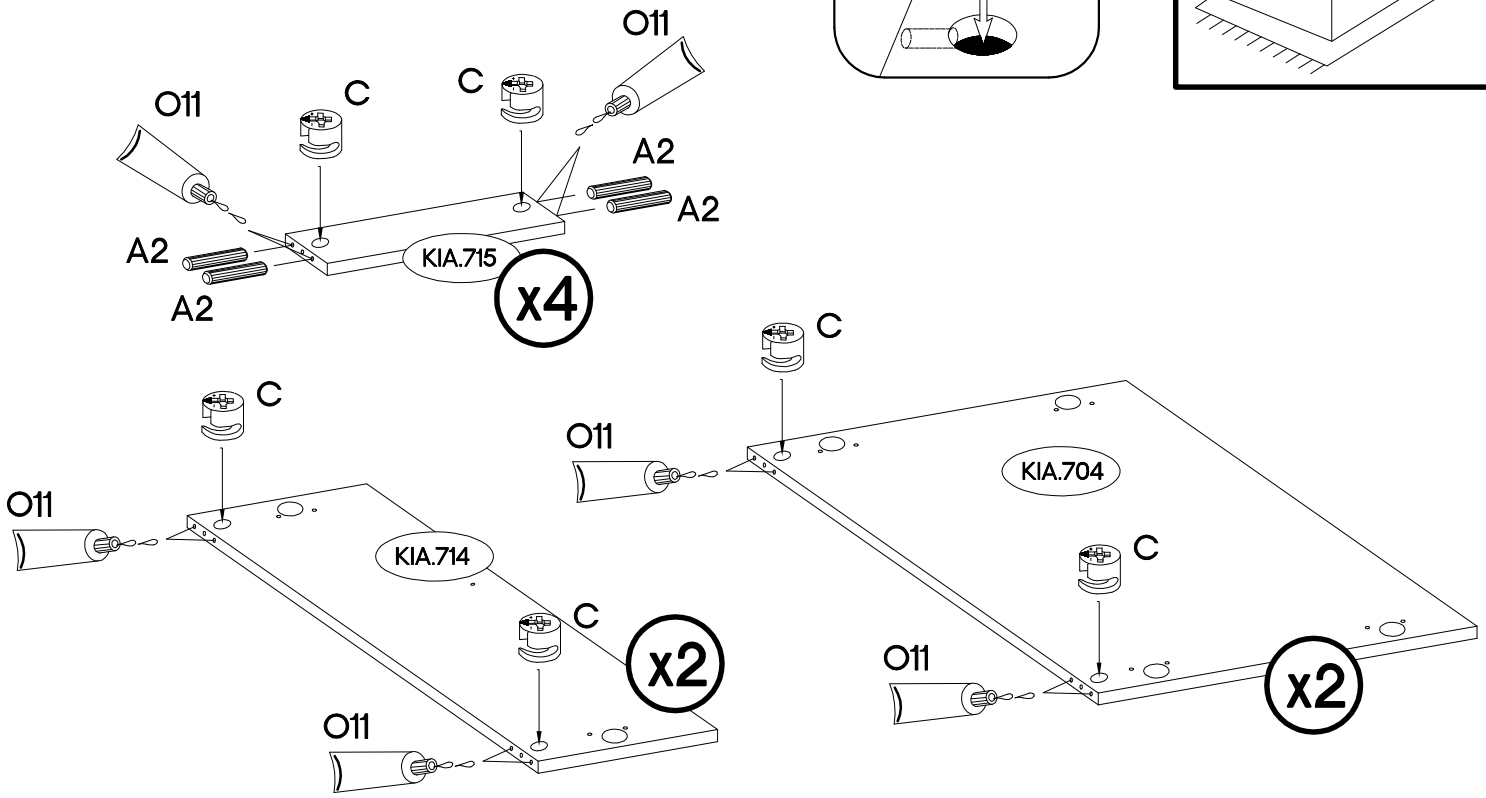
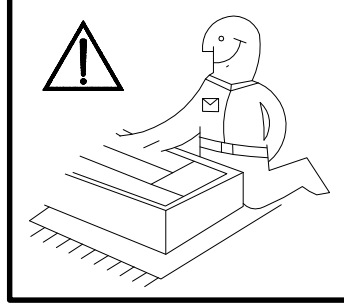
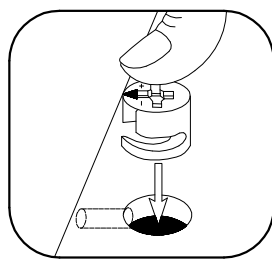



#15/12mm  C 16	#8x60mm  A2 16	0,05  O11 1
---	---	--

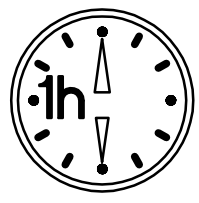
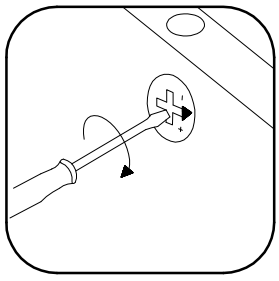
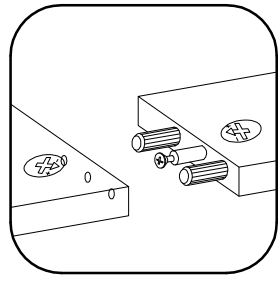
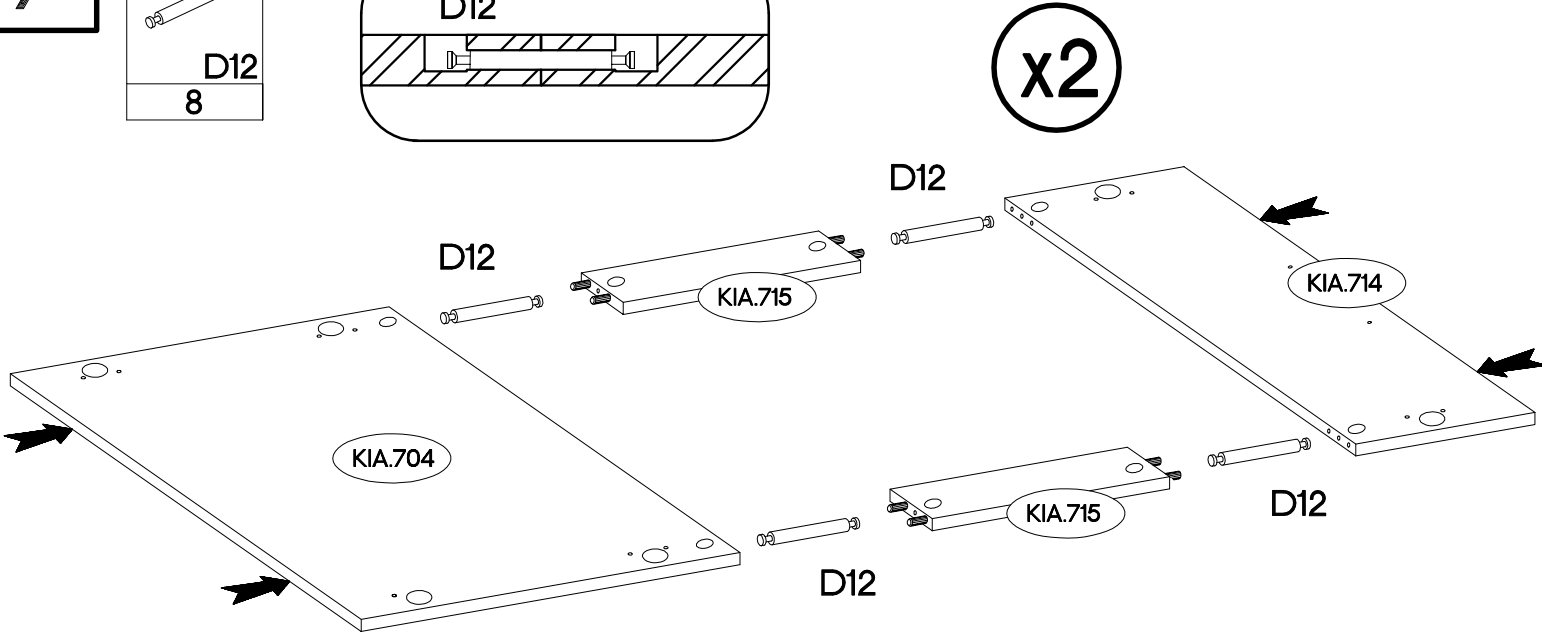
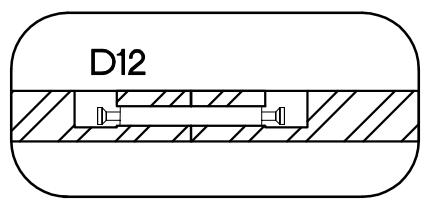





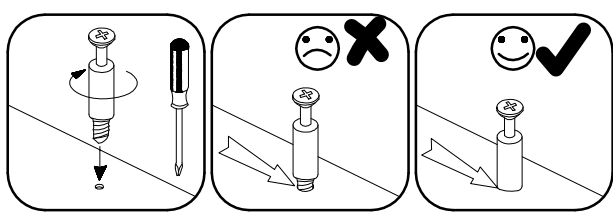
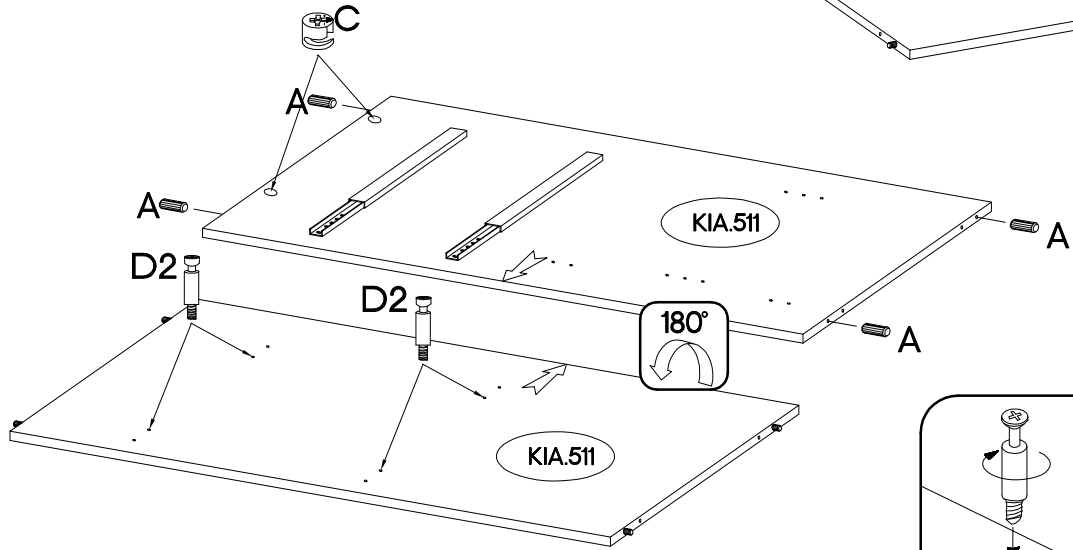
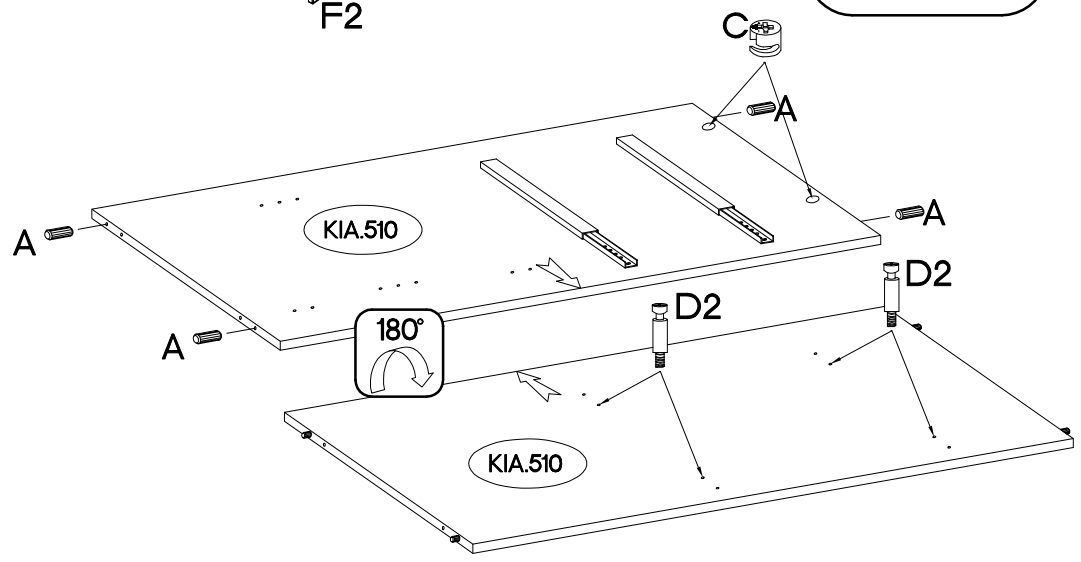
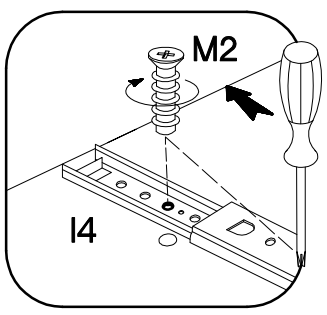
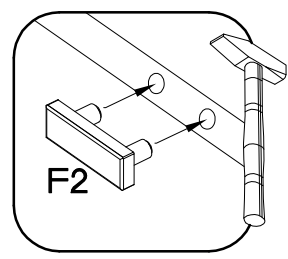
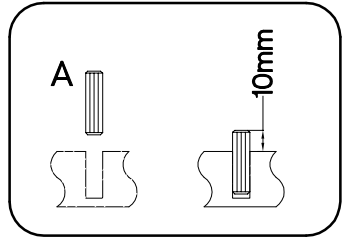
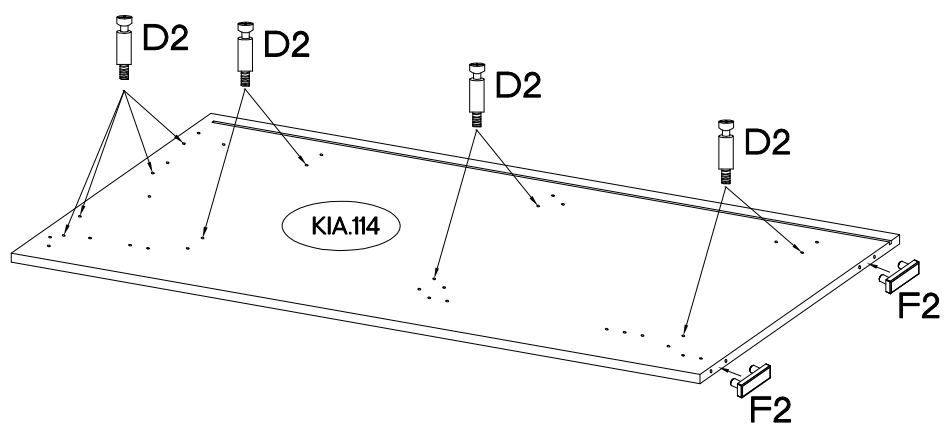
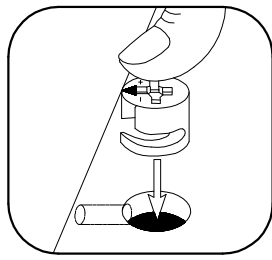
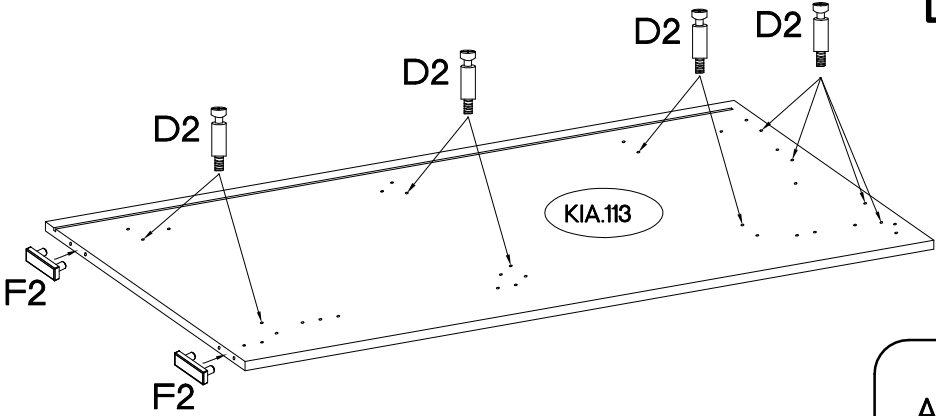
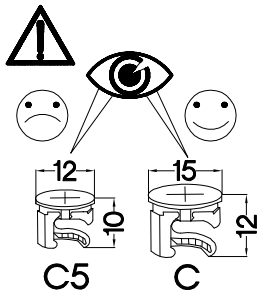
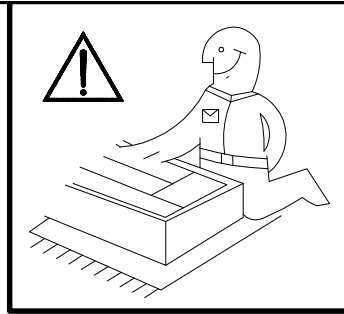

7

L=40mm  D12 8
---





±8x30mm  A	L=20mm  D2	±15/12mm  C	6.5x48x16  F2	27/310mm  I4	±6,3x13mm  M2
8	28	4	4	2	8

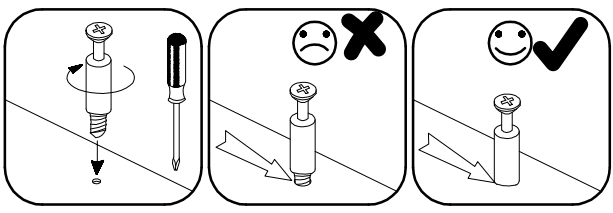
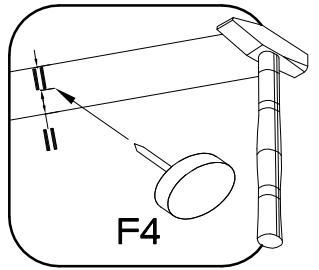
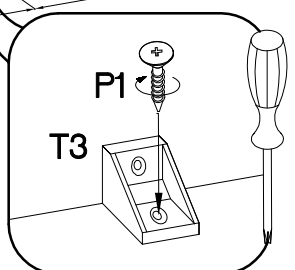
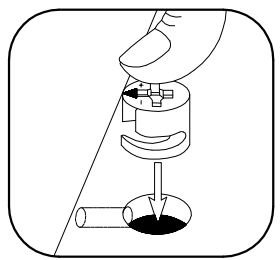
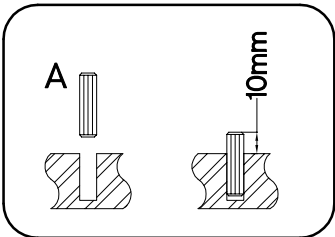
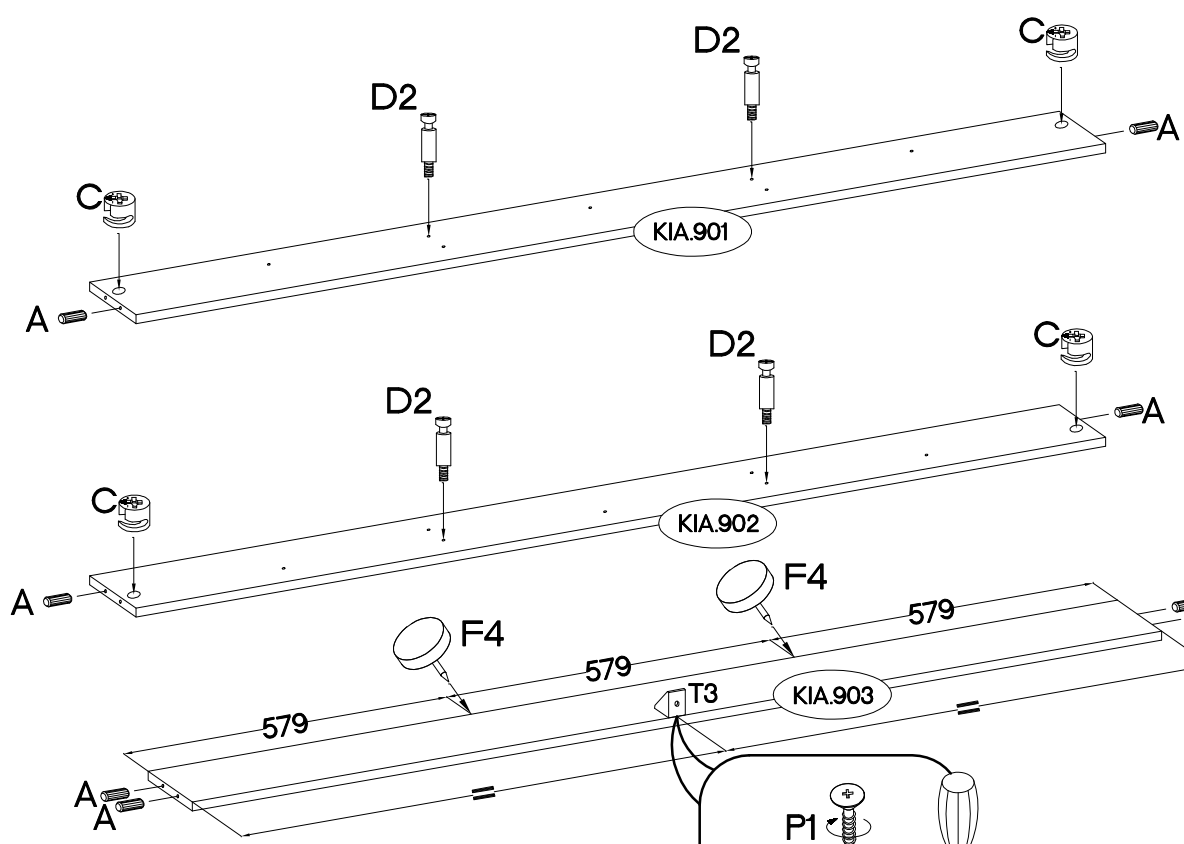
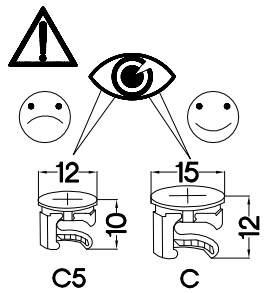
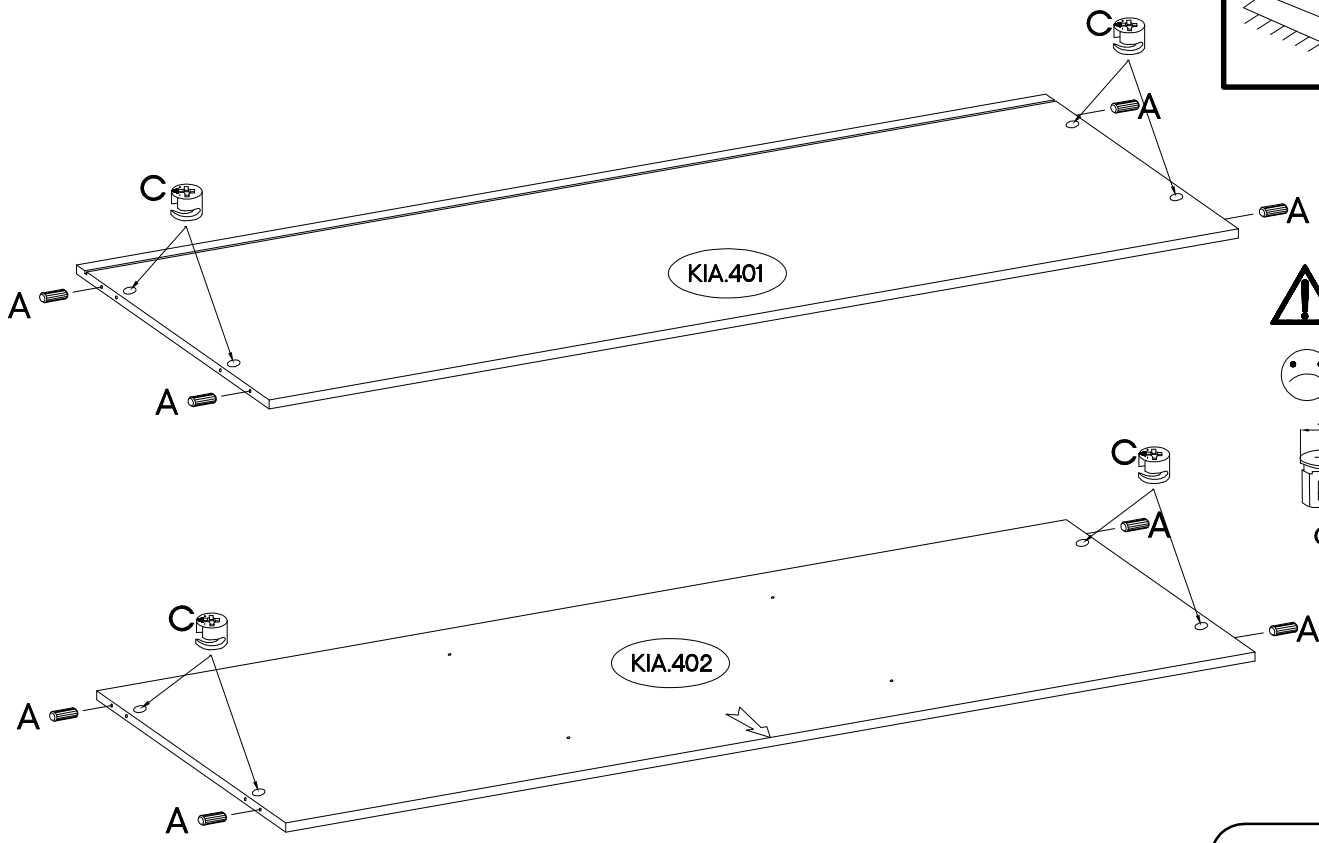
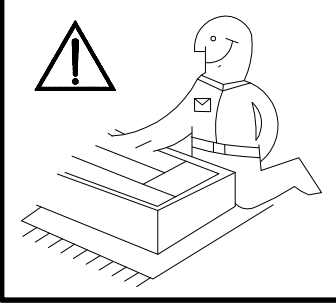

+8x30mm  A 16	L=20mm  D2 4	+15/12mm  C 12	 T3 1	+4.0x16mm  P1 1	+15x5mm  F4 2
--	---	---	---	--	--



# 10

+8x20mm  A4 4	+8x30mm  A 16	+15/12mm  C 16
--	--	---

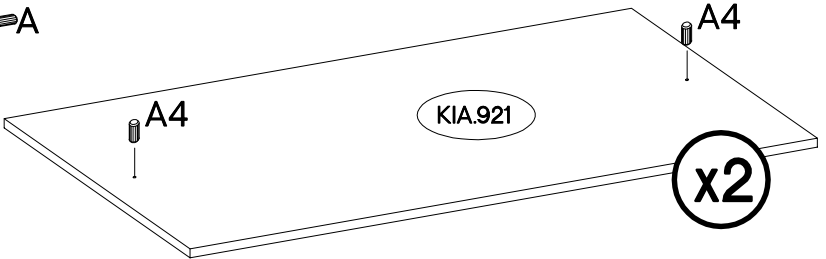
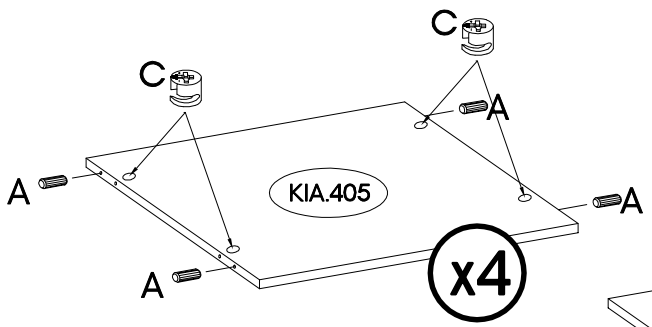
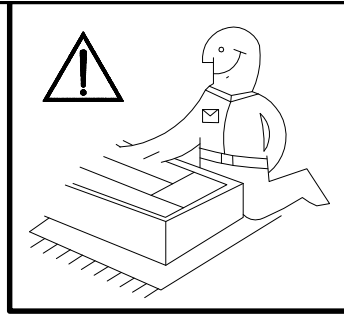
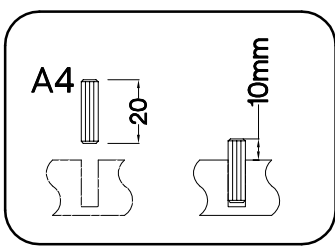

# 11

+3.5x25mm BLACK  P25 14
--

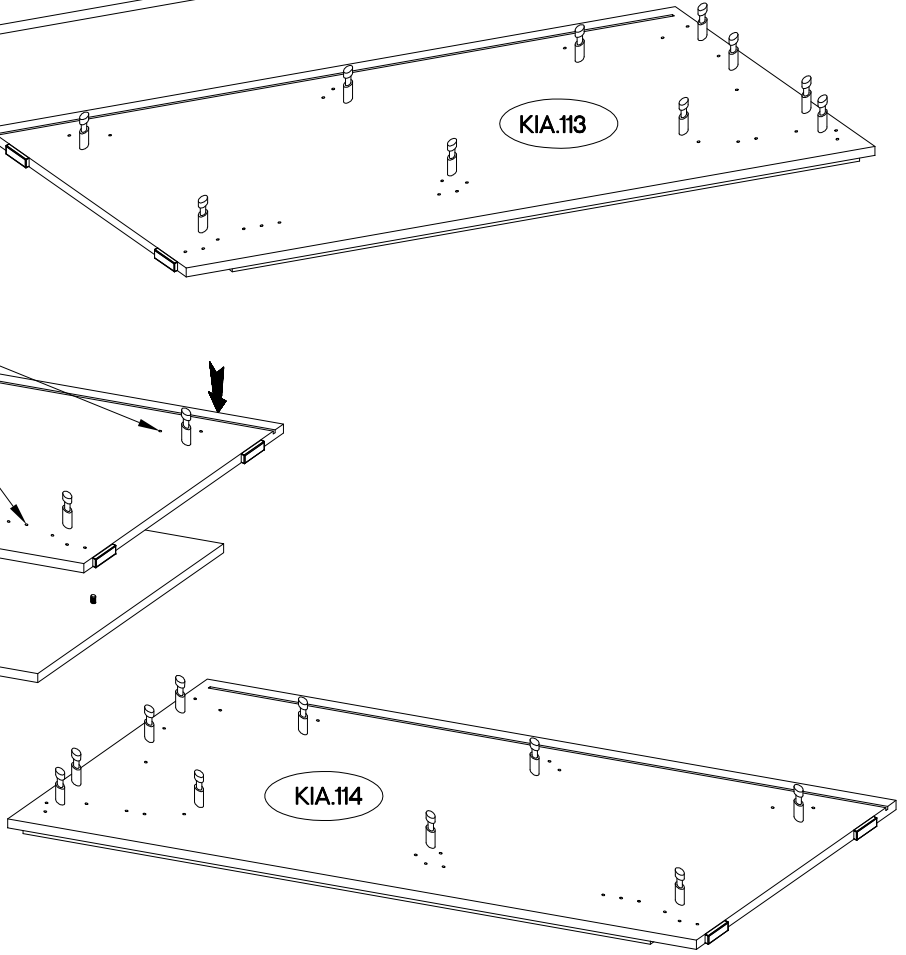
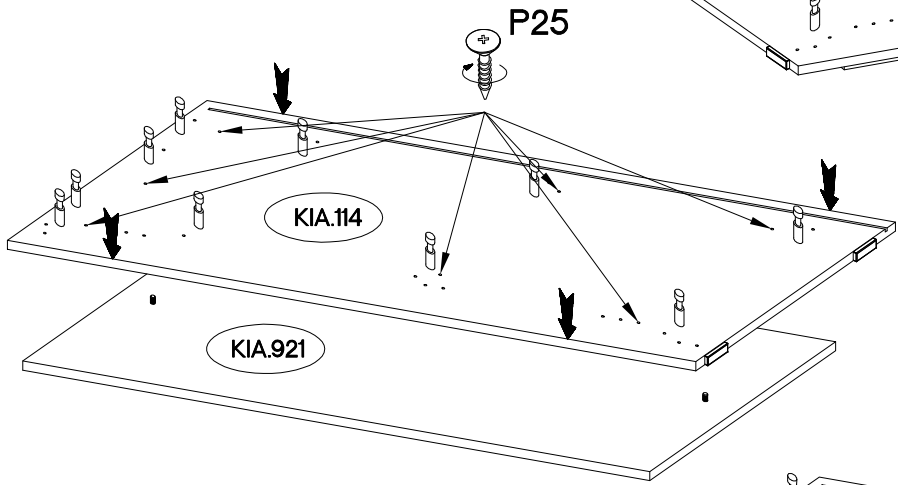
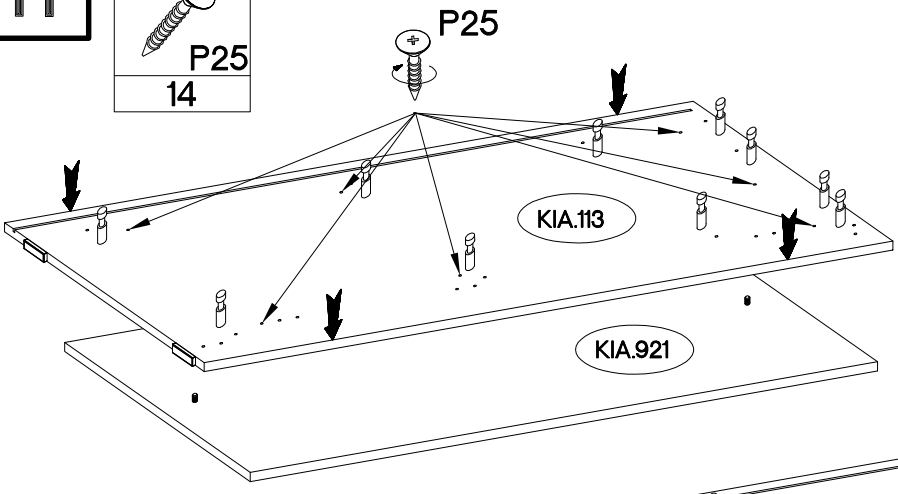
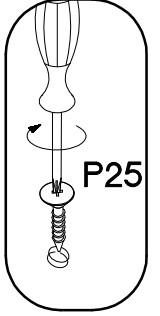

# 12

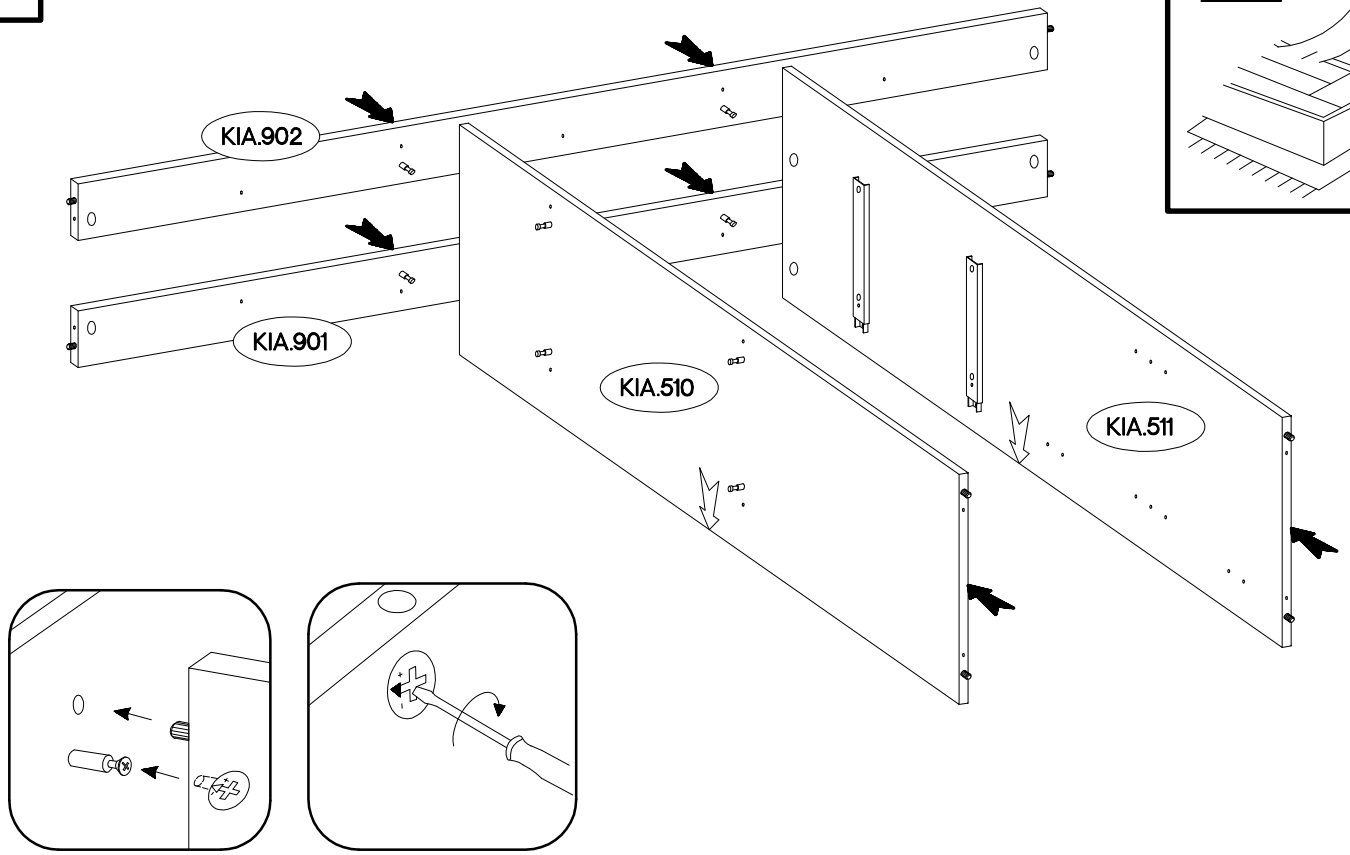
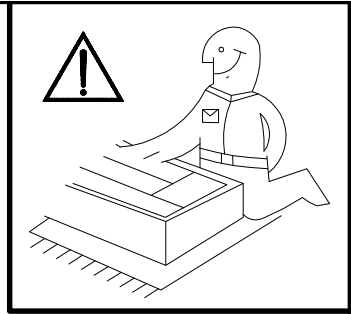

# 13

6,4 x 50mm

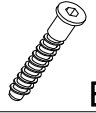
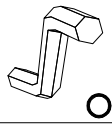
	
B	O
4	1

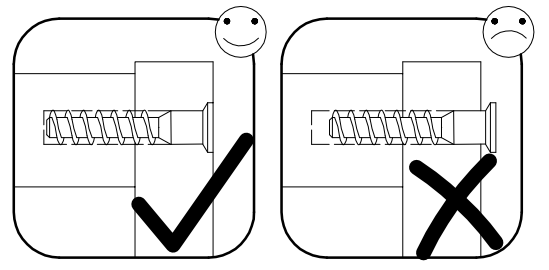
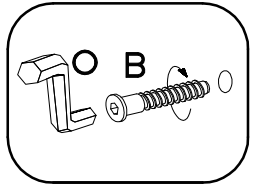
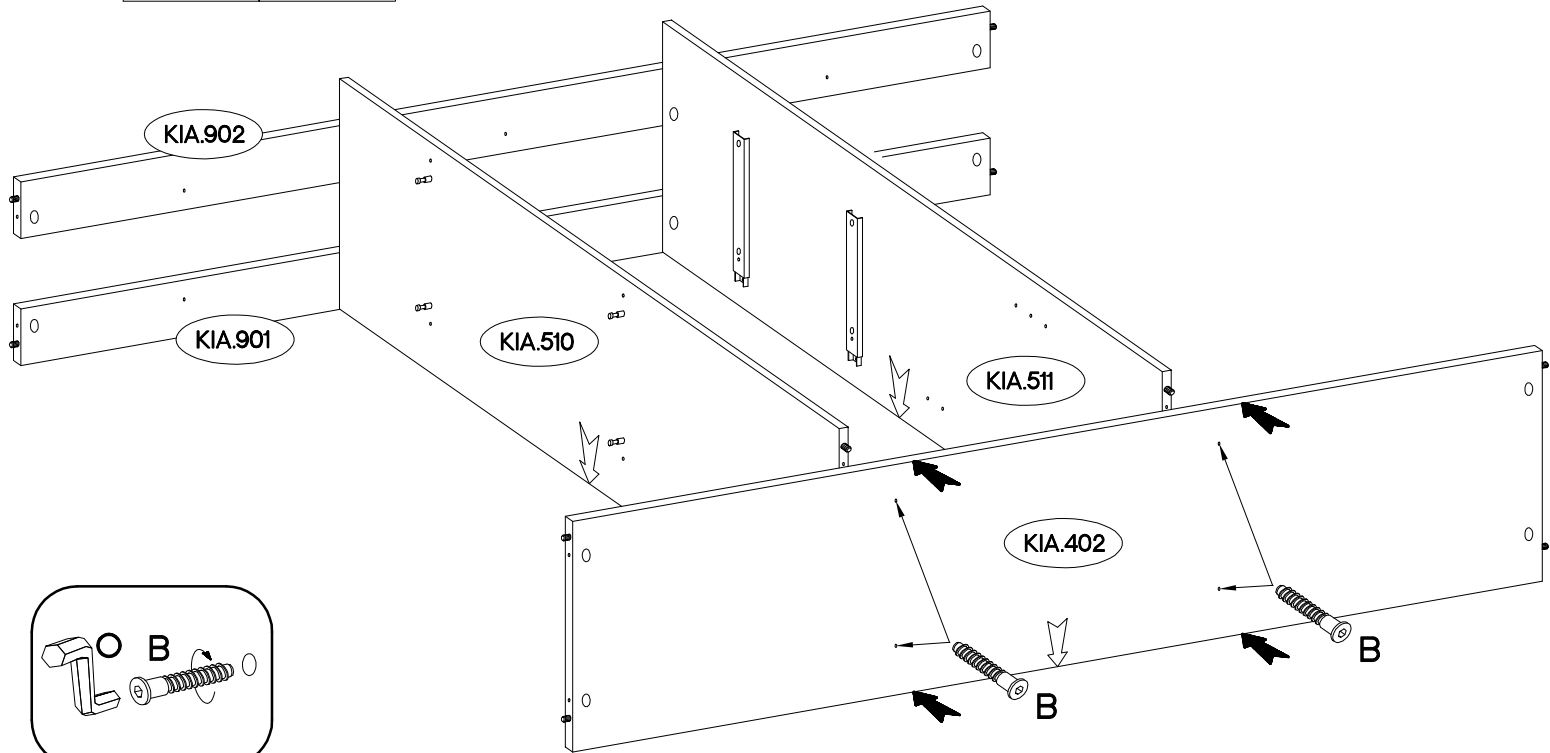

14

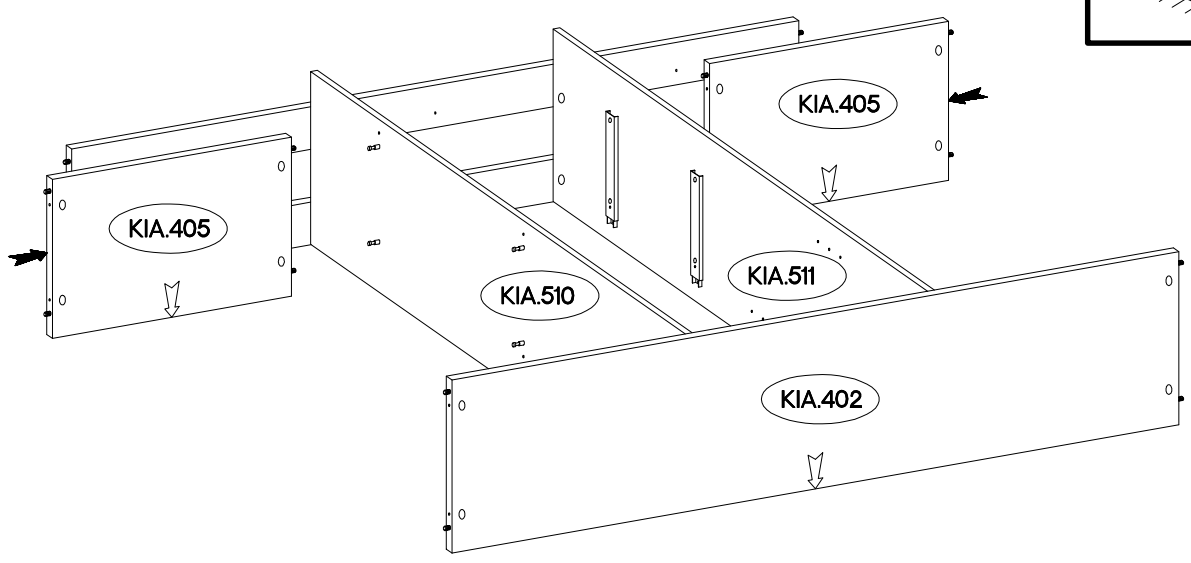
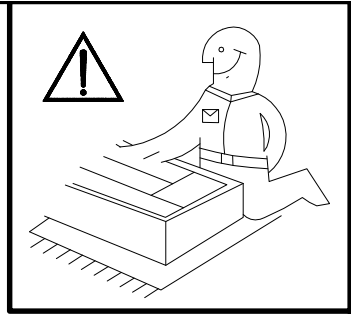

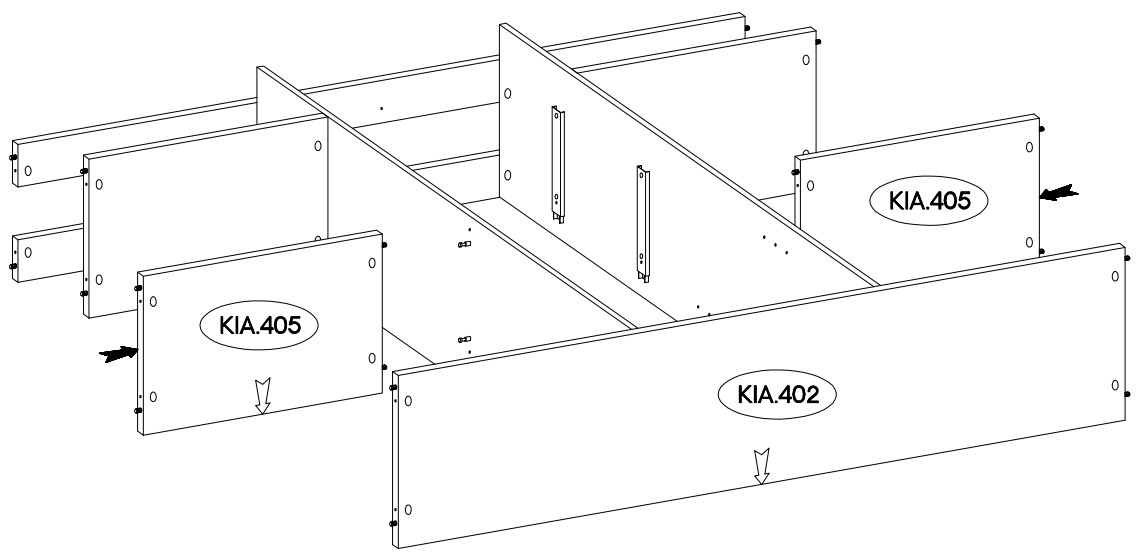
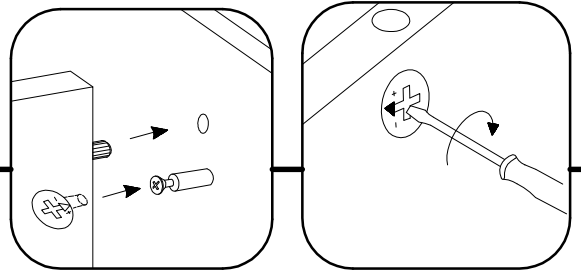

15

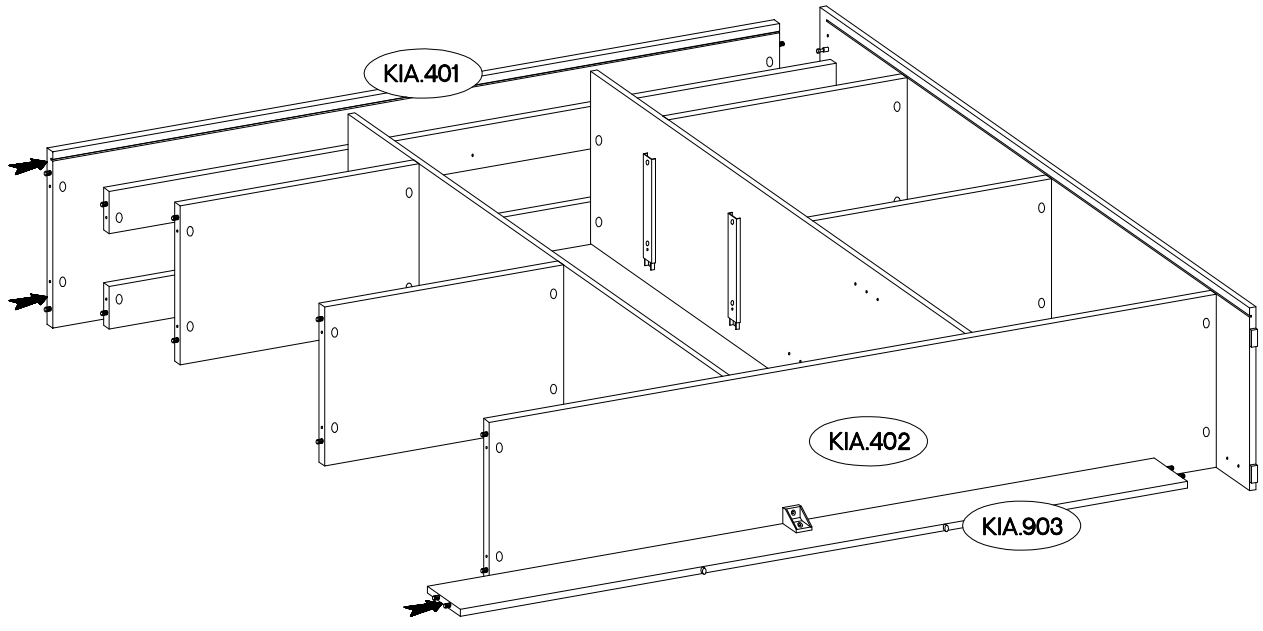
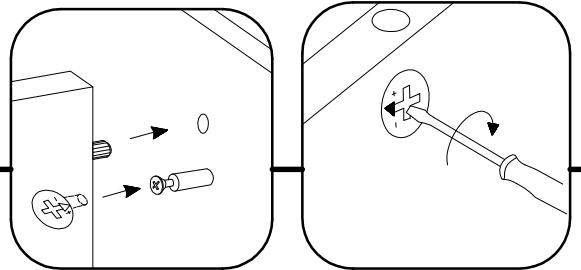
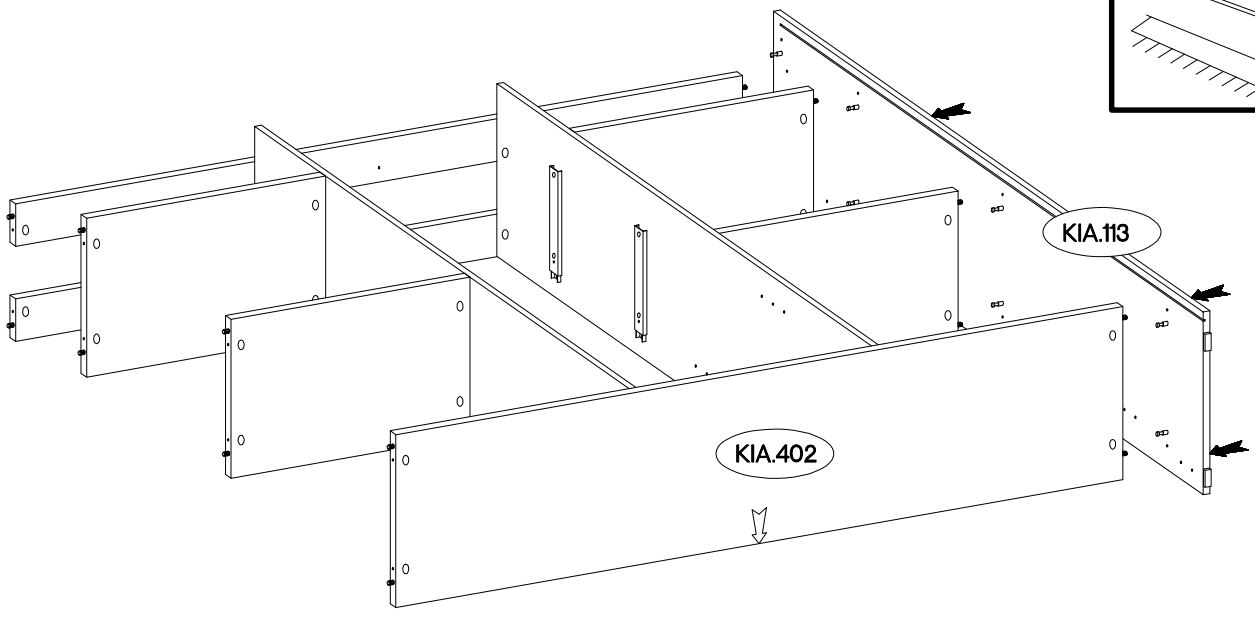
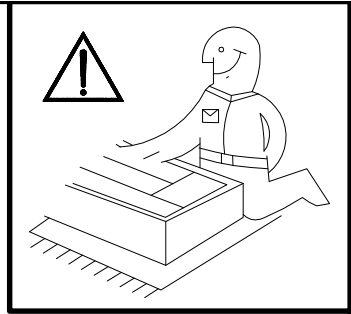

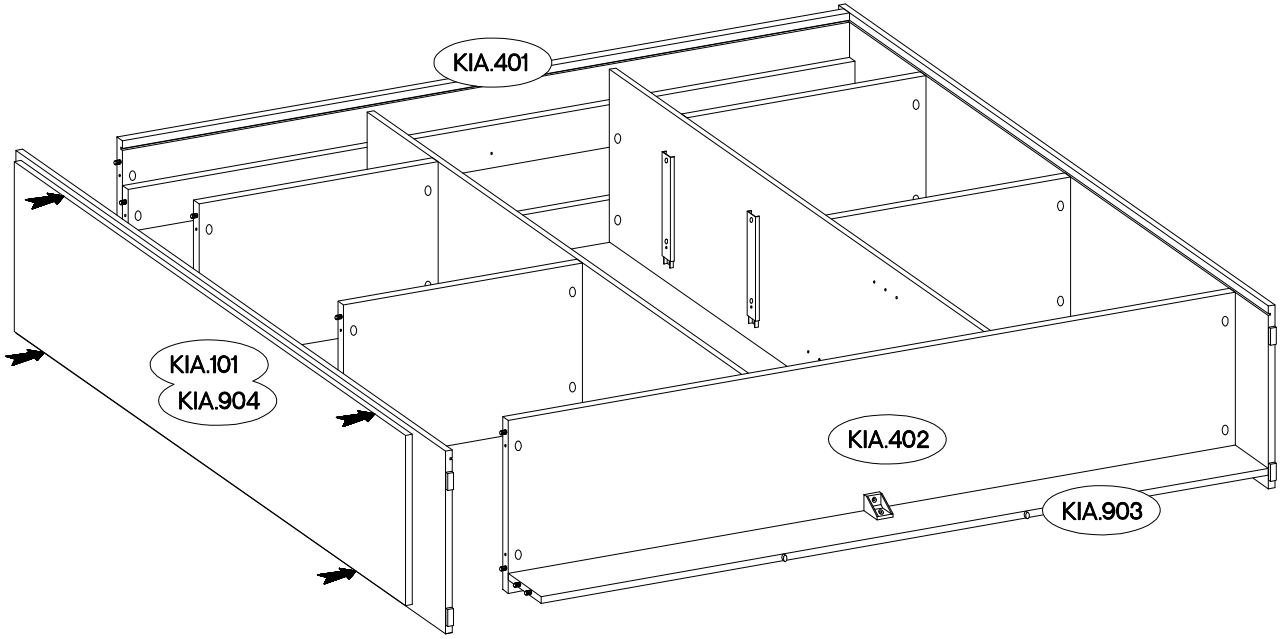
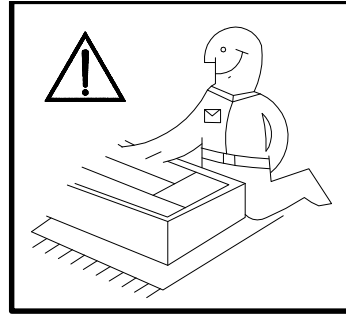
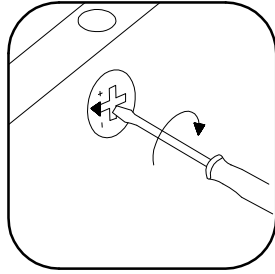
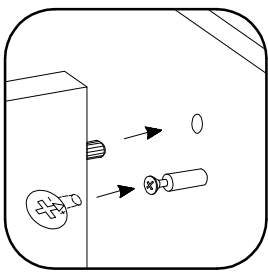





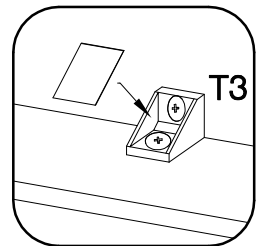
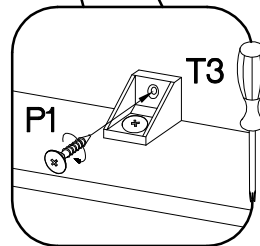
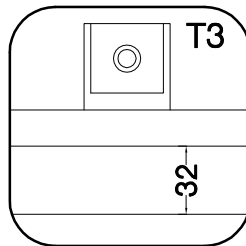
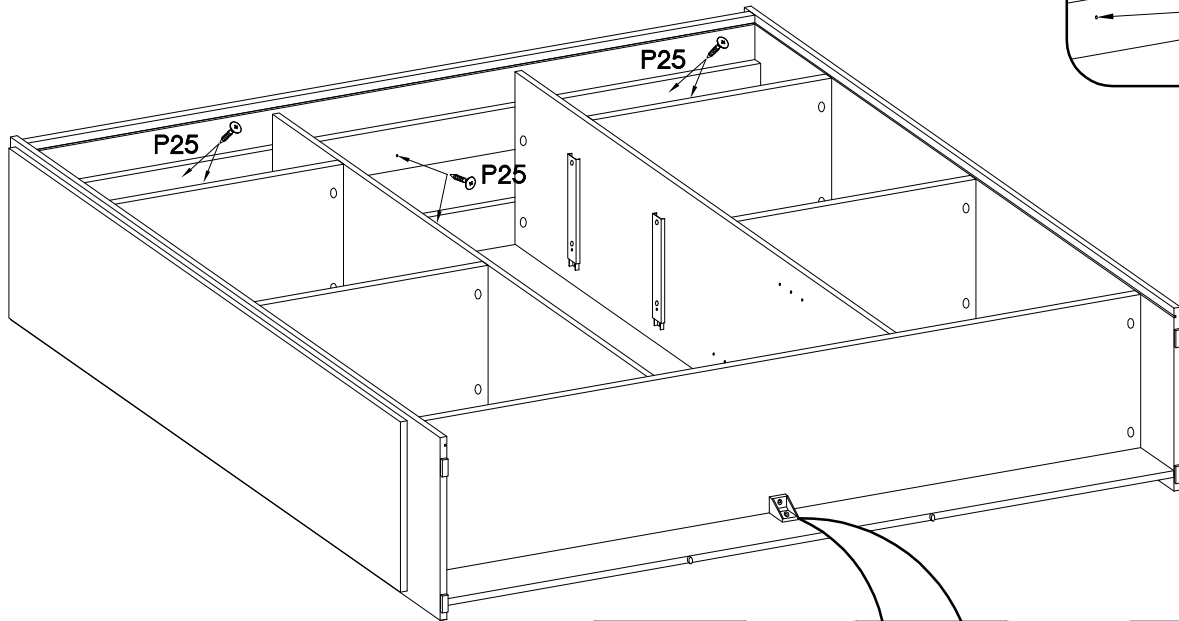
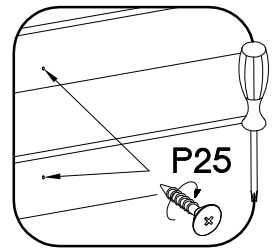

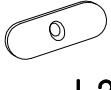

†3.5x25mm BLACK  <b>P25</b> 6	†4.0x16mm  <b>P1</b> 1
--	--

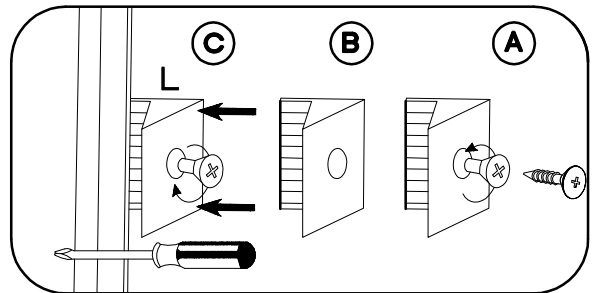
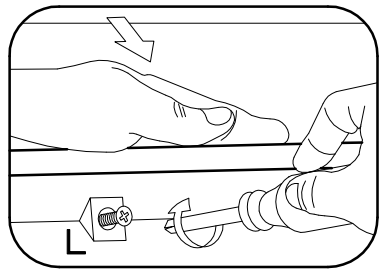
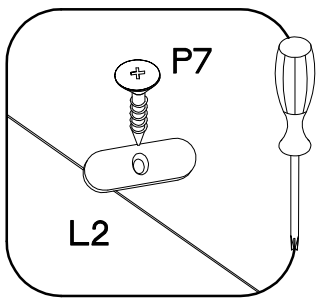
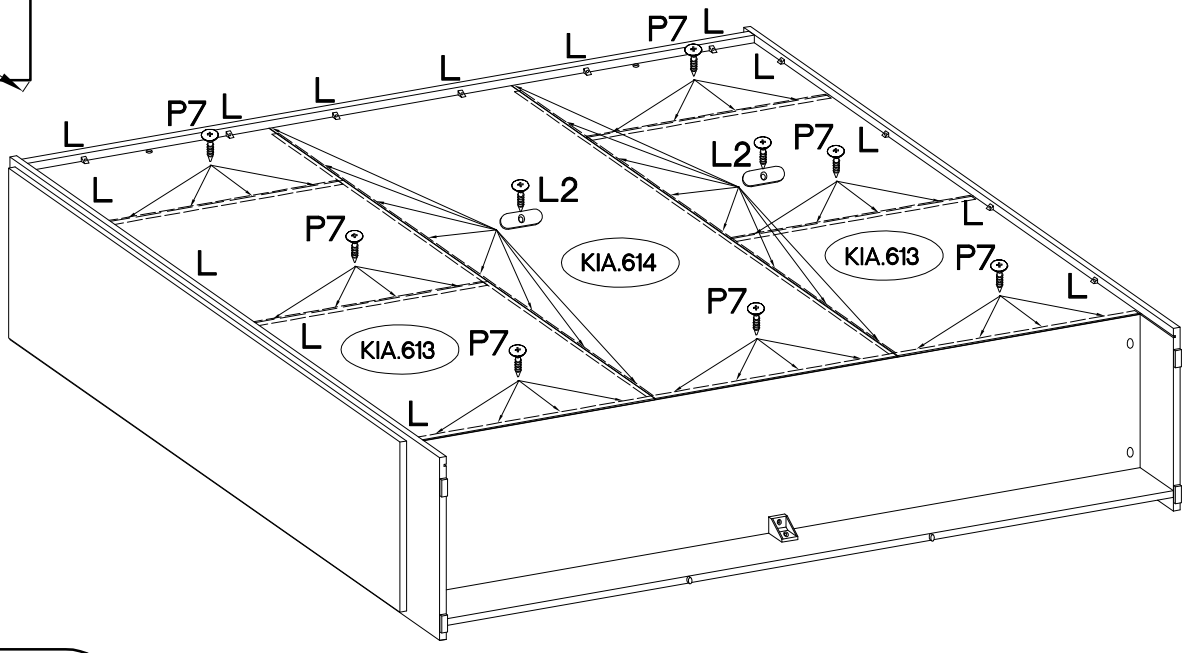
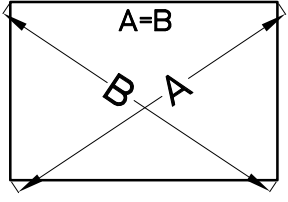
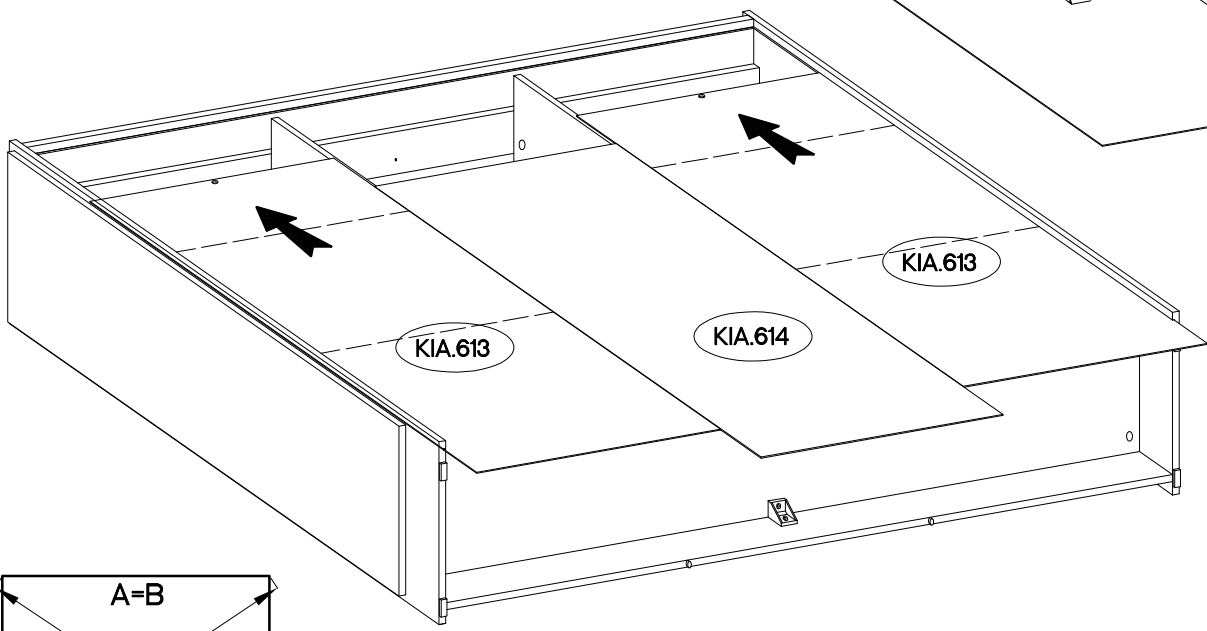
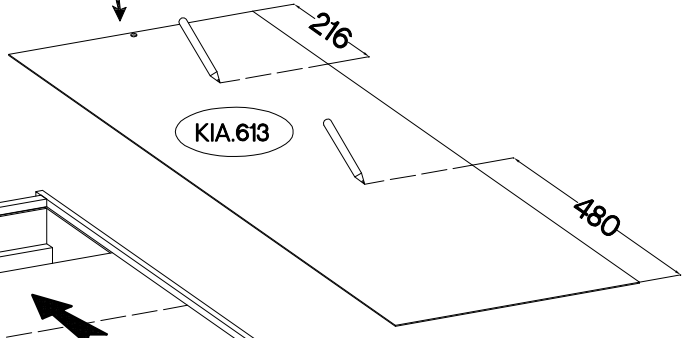
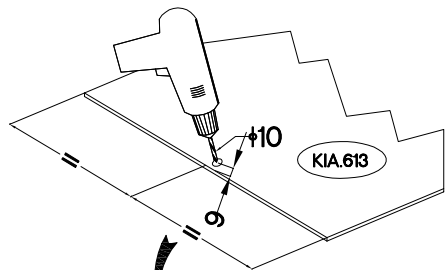
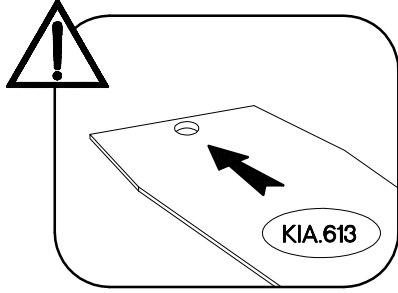
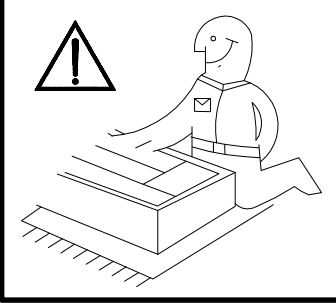



 <b>P7</b> 44	 <b>L2</b> 16	 <b>L</b> 14
---	---	--

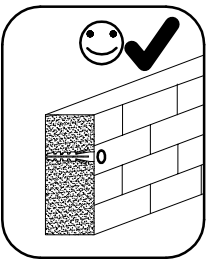
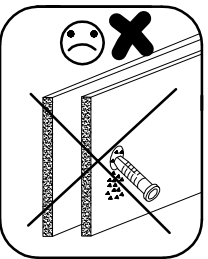
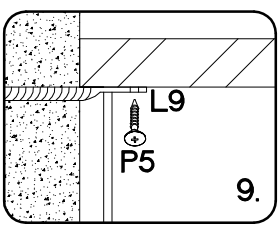
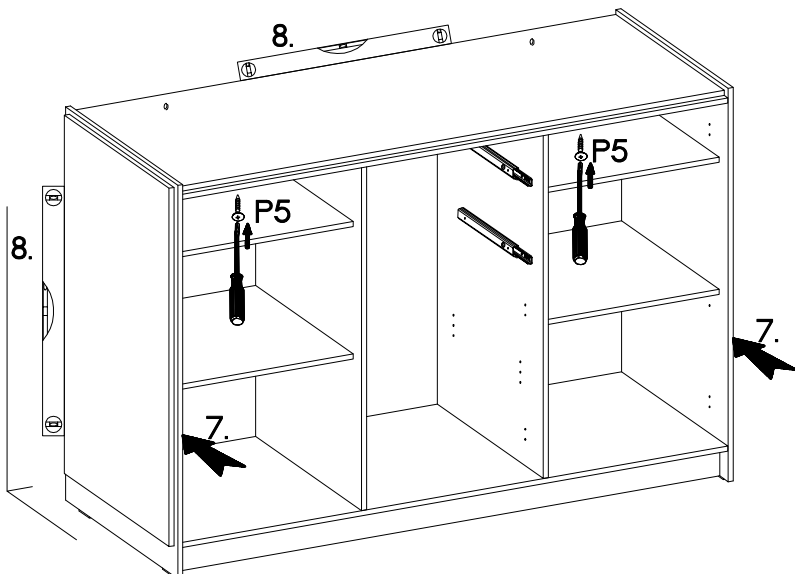
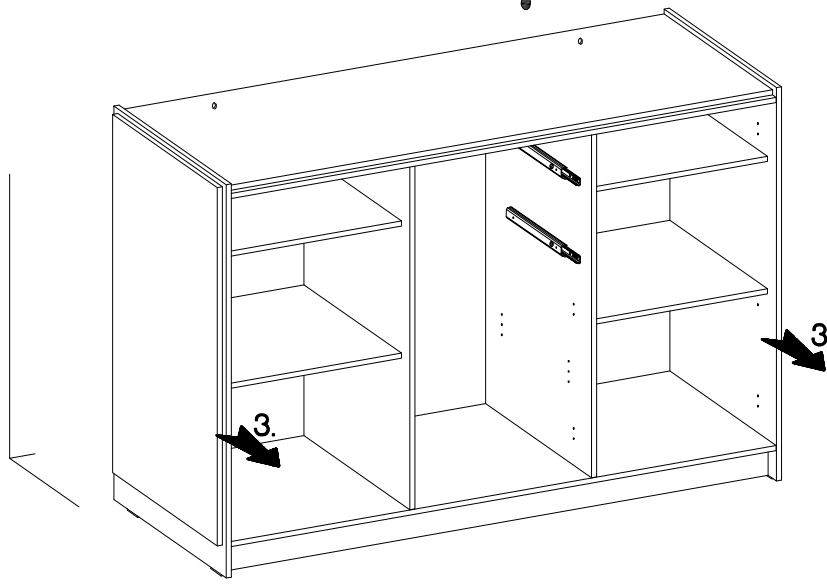
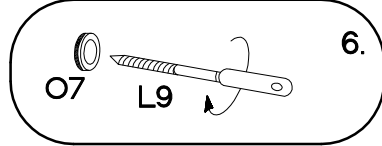
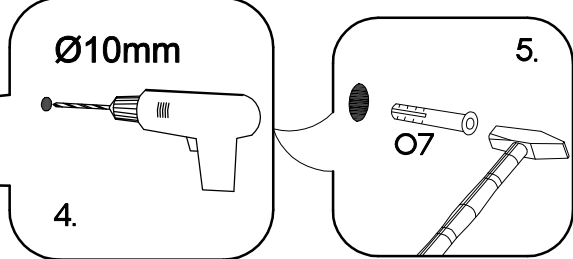
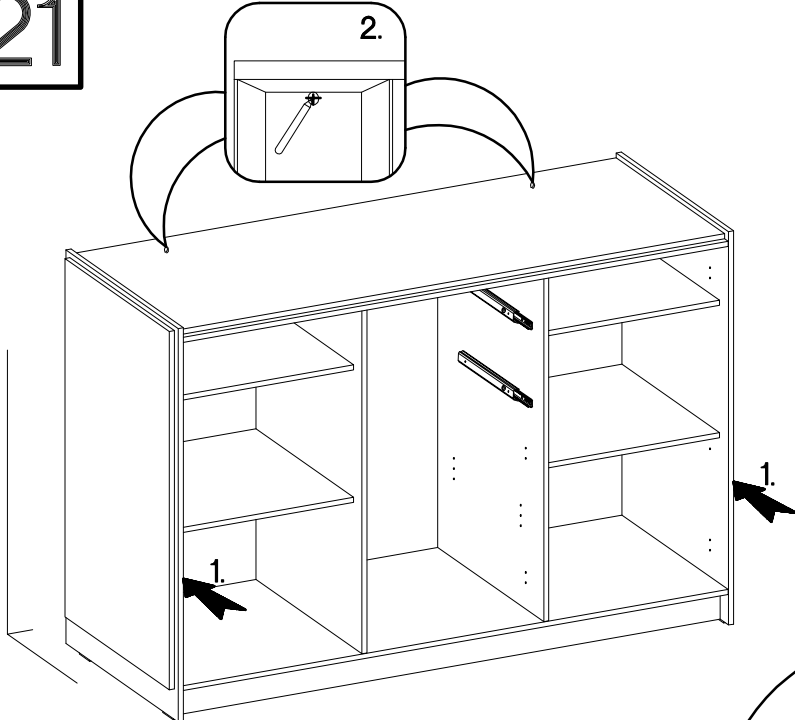

$\pm 10 \times 50 \text{mm}$ 		$\pm 3.5 \times 13 \text{mm}$ 
O7	L9	P5
2	2	2





# 22

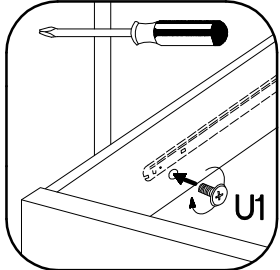
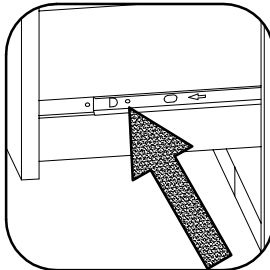
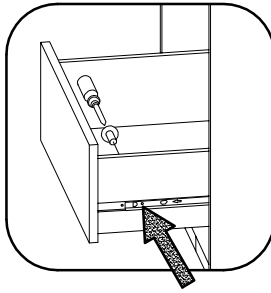
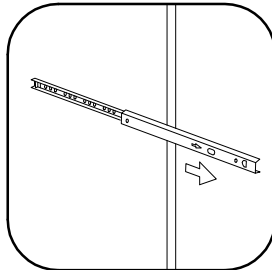
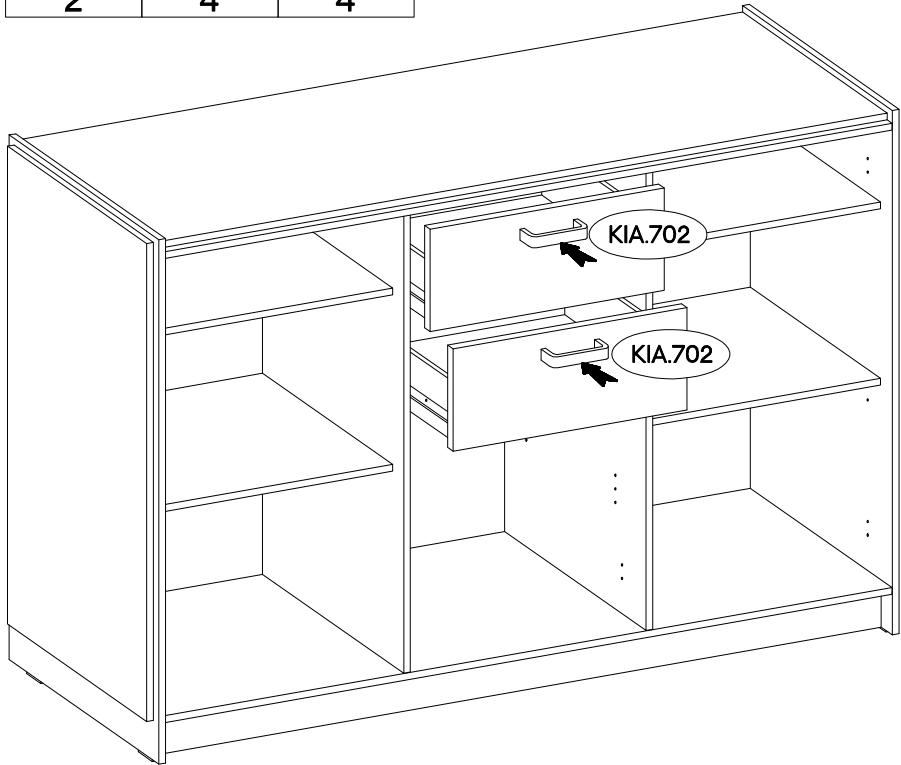
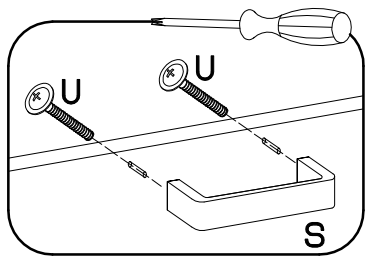



L=128mm	M4x22mm	M4x9mm
		
S	U	U1
2	4	4



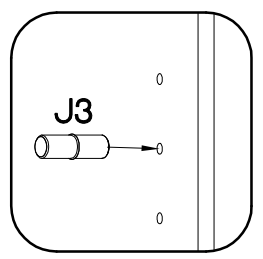
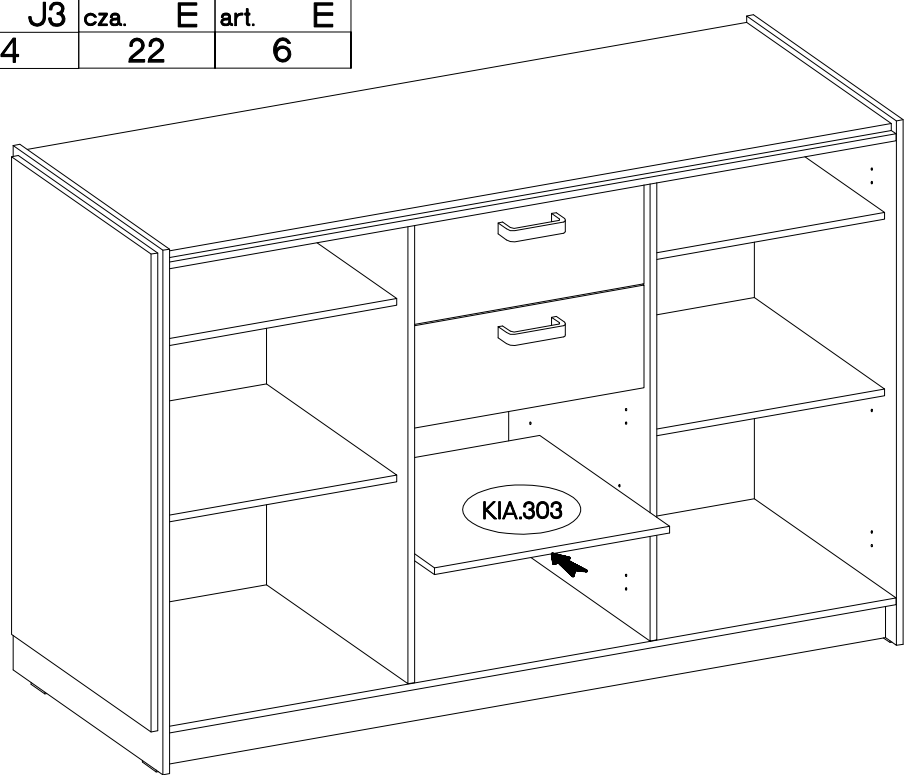
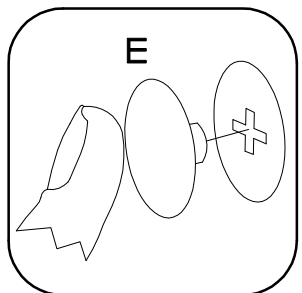

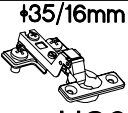
# 23

±5/16mm		
J3	cza. E	art. E
4	22	6



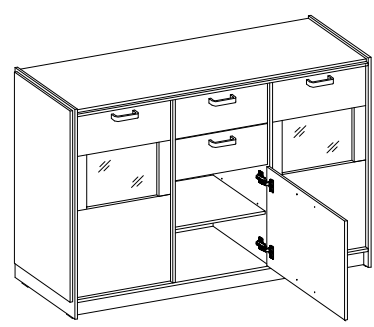
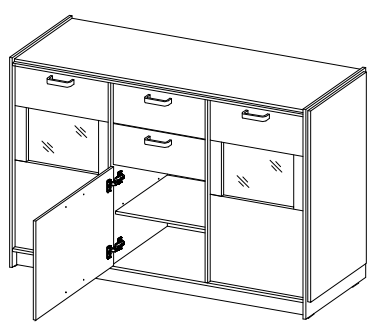
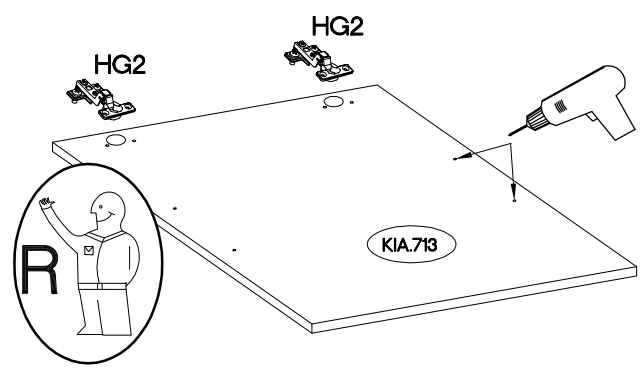
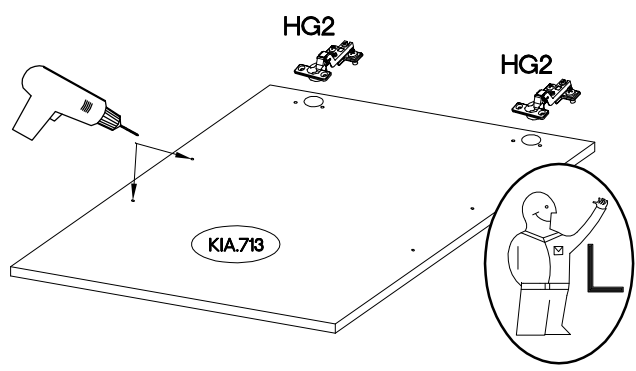
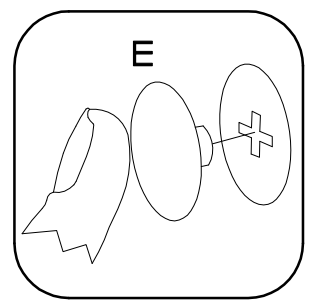
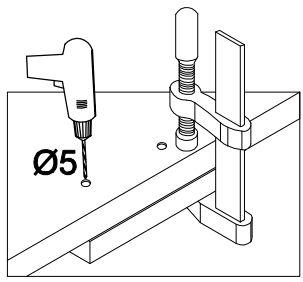
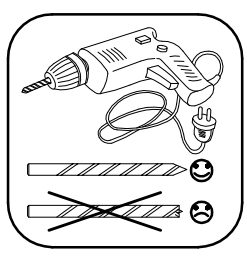
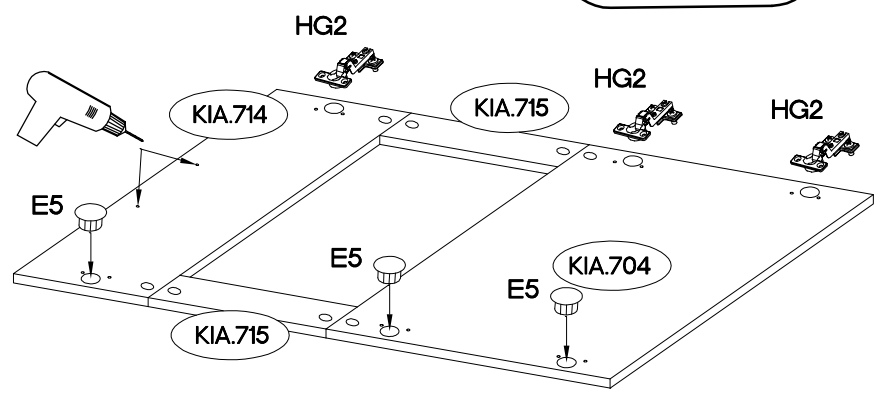
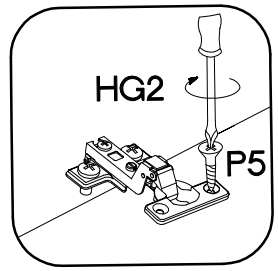
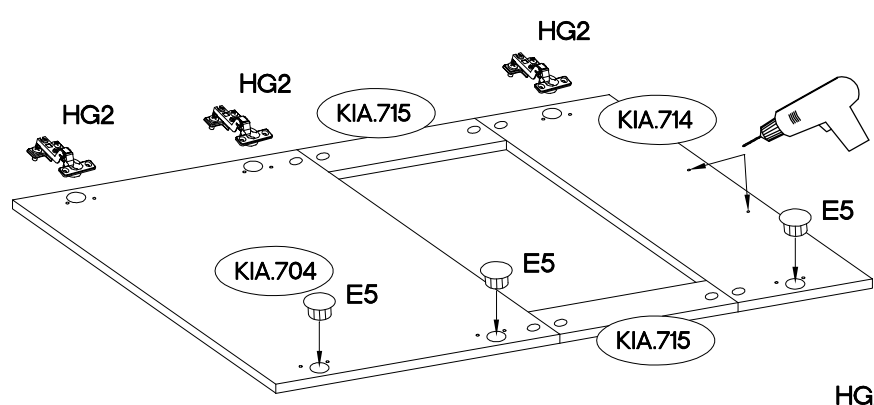
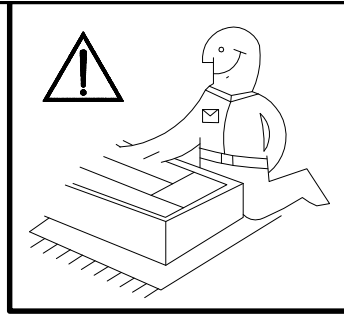

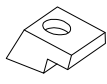
 $\varnothing 35/16\text{mm}$	 $\varnothing 3.5 \times 13\text{mm}$	 $\varnothing 35\text{mm}$	
HG2	P5	E5 art.	E
8	16	6	16



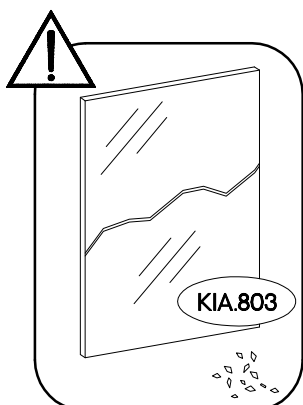
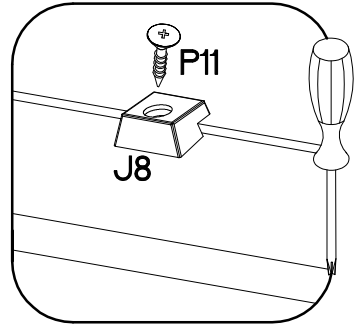
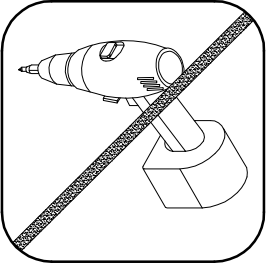
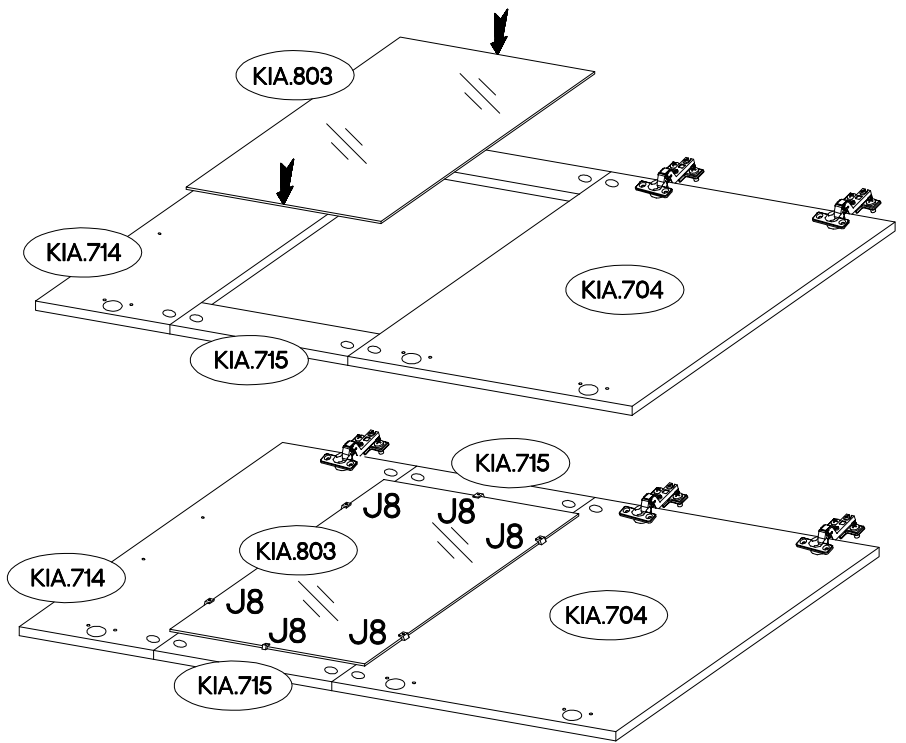
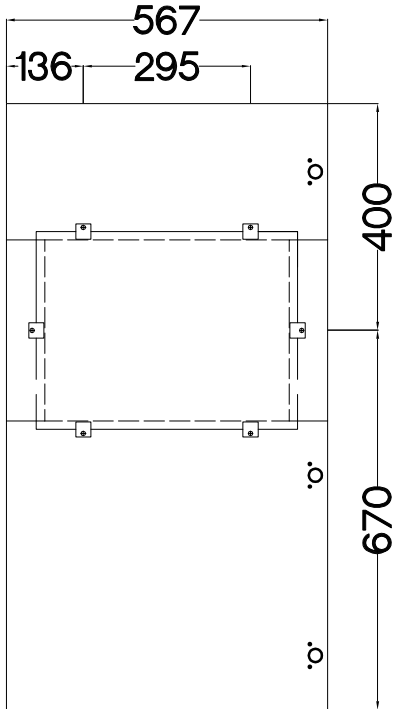
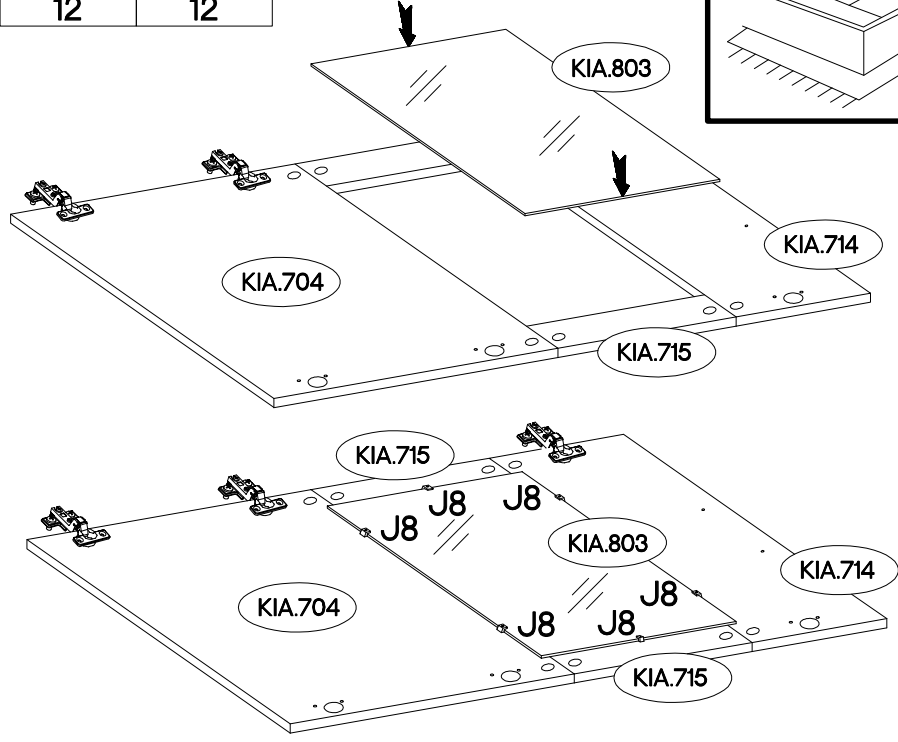
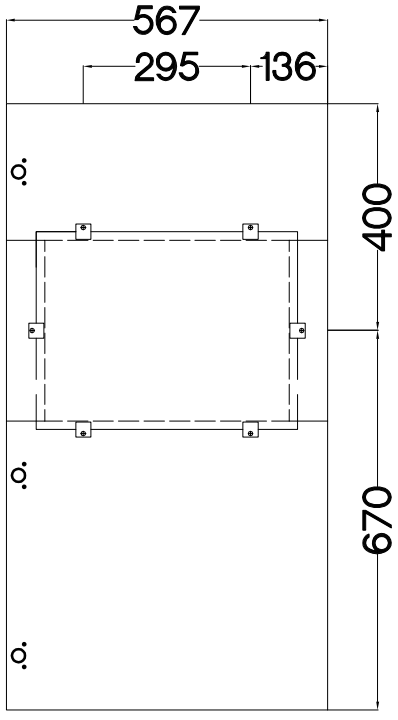
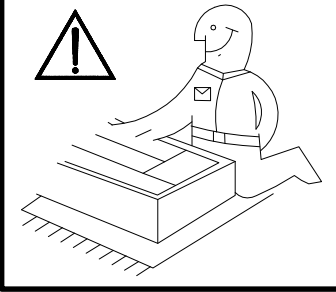

 J8 12	 P11 12
--	---

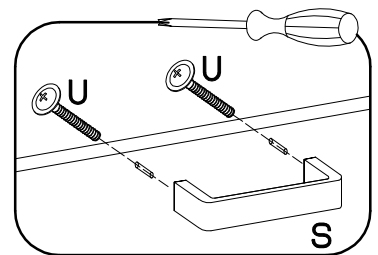
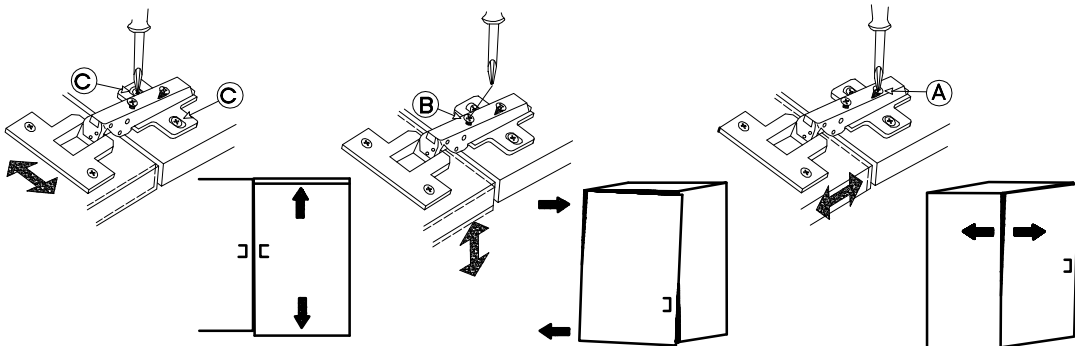
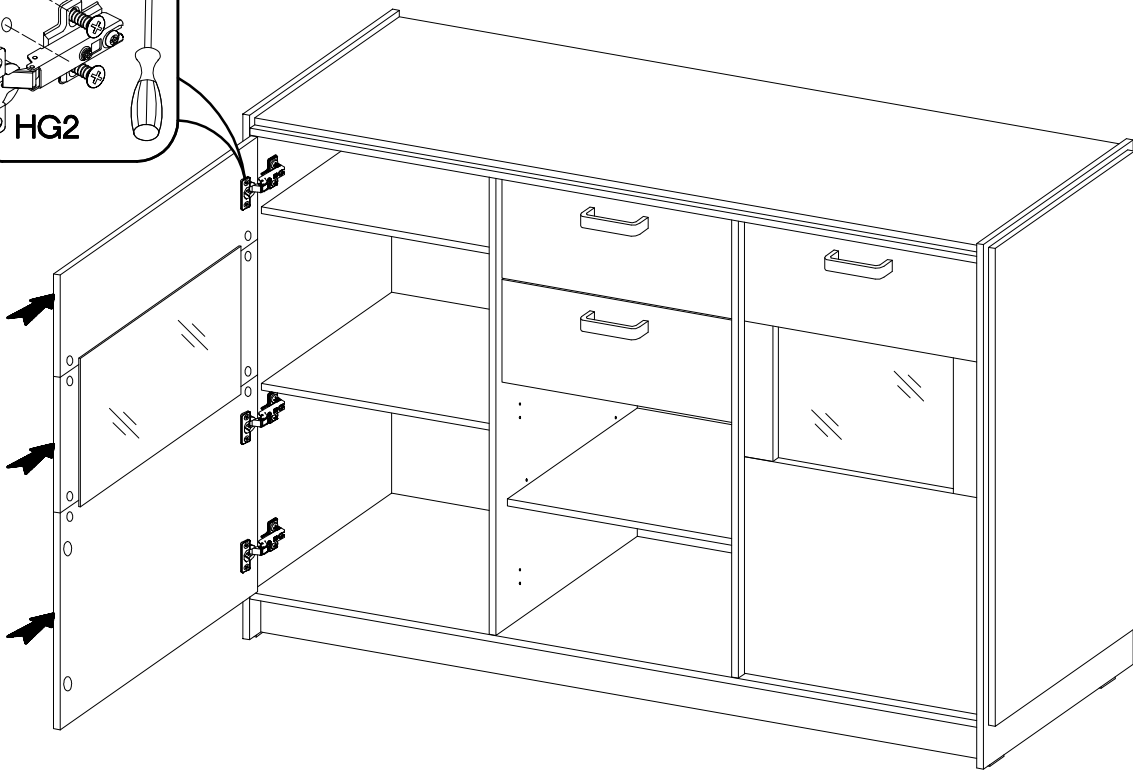
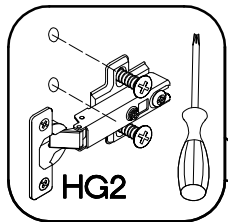
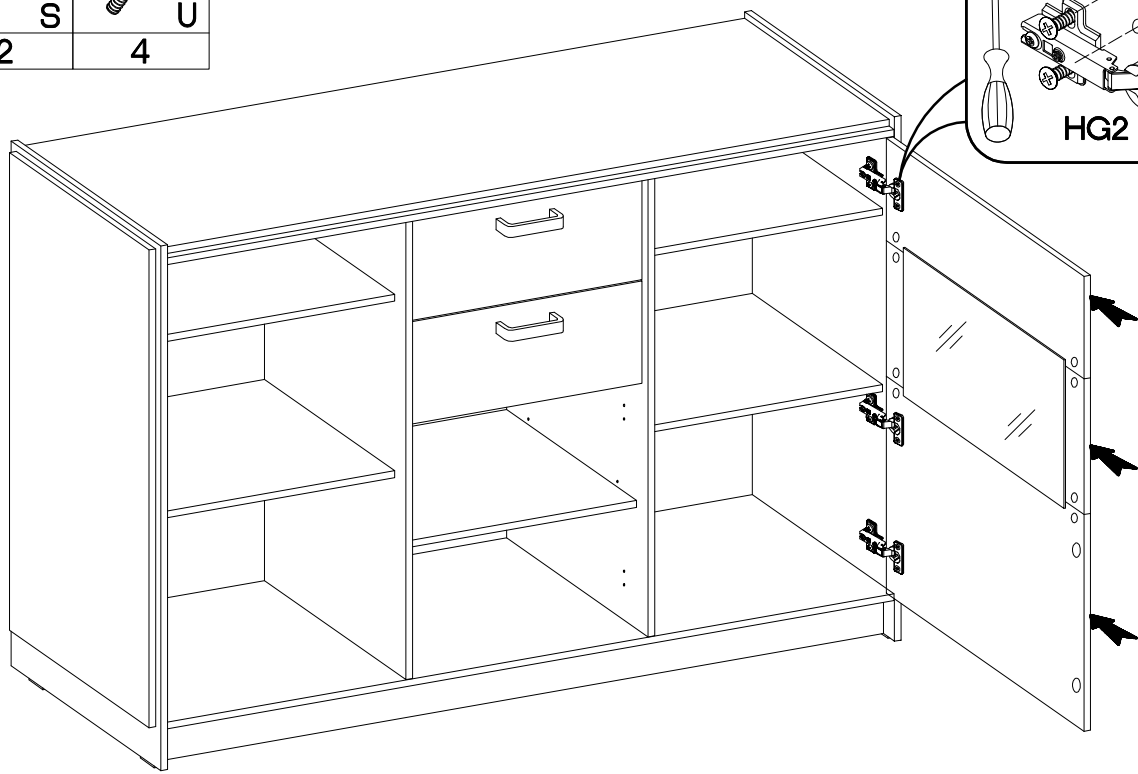

L=128mm	M4x22mm
	
S	U
2	4



L=128mm	M4x22mm
	
S	U
1	2

