

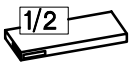

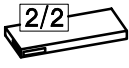

	Ersatzteil Nummer	Dimension
	OIO.501 x2	672x384x16
	OIO.504 x2	672x384x16
	OIO.702 x3	666x412x16
	OIO.101	672x544x16
	OIO.201	1646x423x16
	OIO.202	1646x423x16
	OIO.301 x2	407x370x16
	OIO.302	399x370x16
	OIO.601 x2	339x1621x2,5

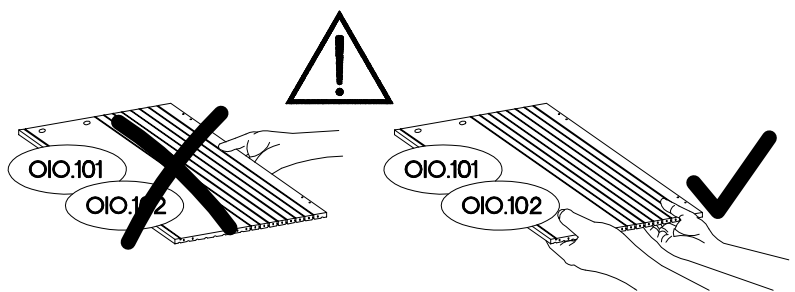

1

±8x30mm  A 60	±15/12mm  C 24	L=20mm  D2 4
--	---	---

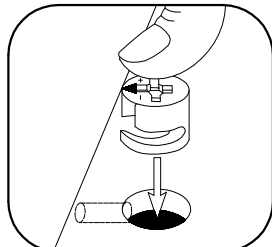
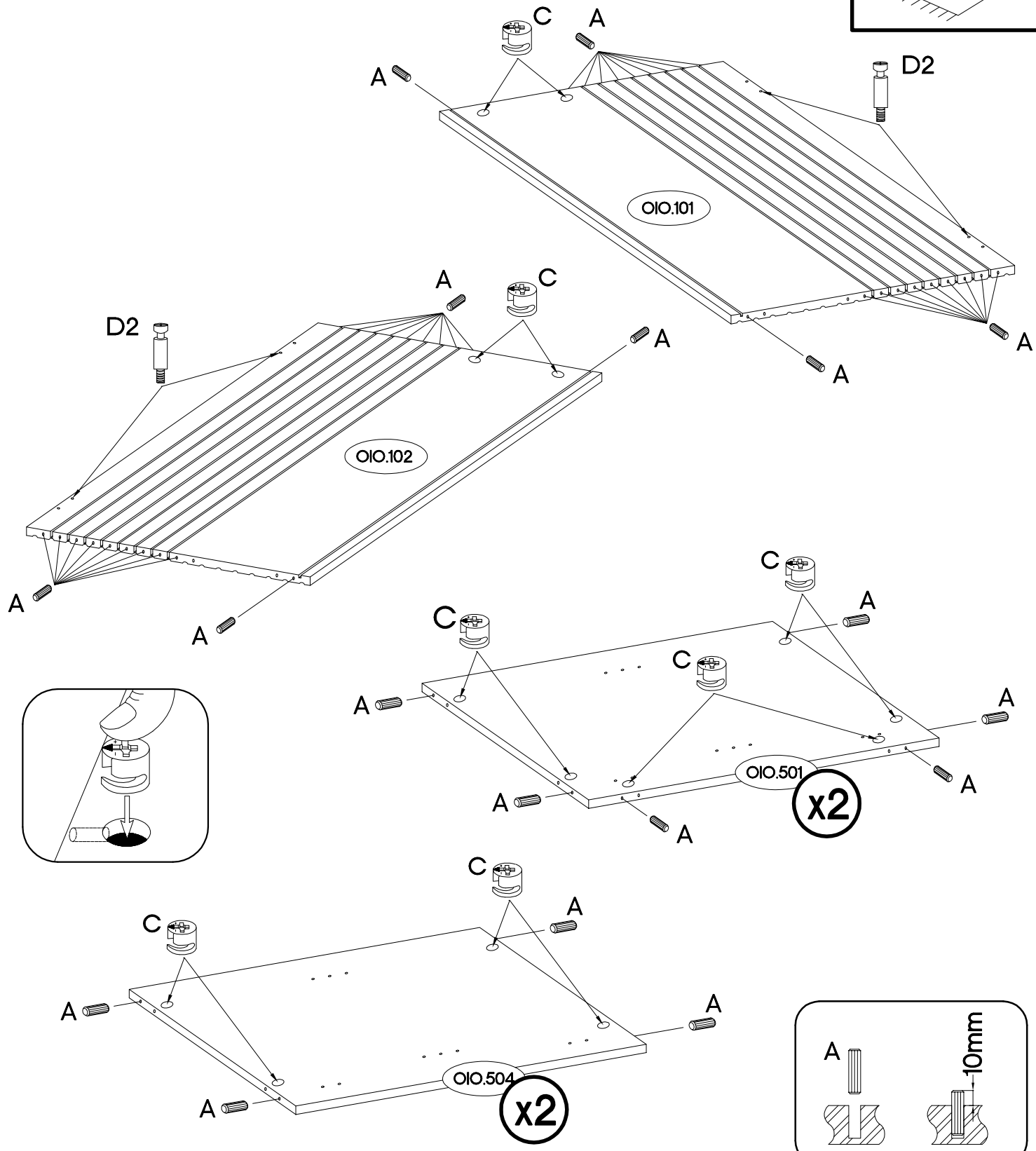
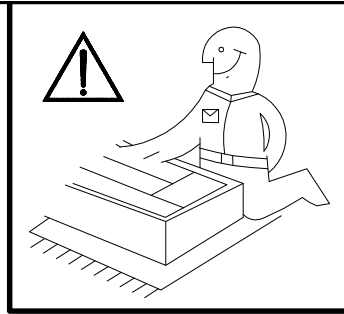

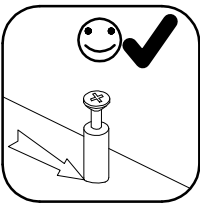
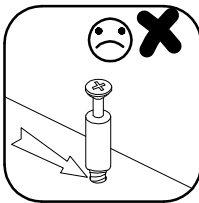
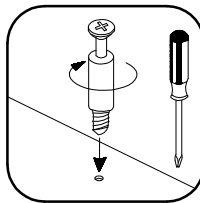
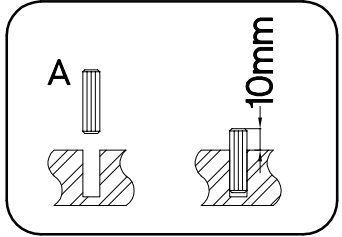

x2

x2

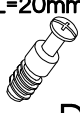

2

L=20mm  D2 20	L=150mm  F40 5	±4.0x16mm  P1 20
--	---	---

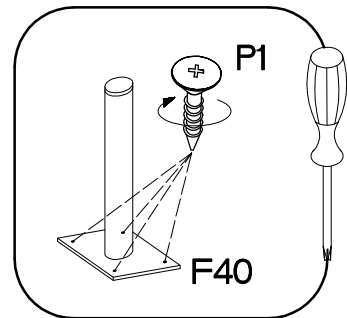
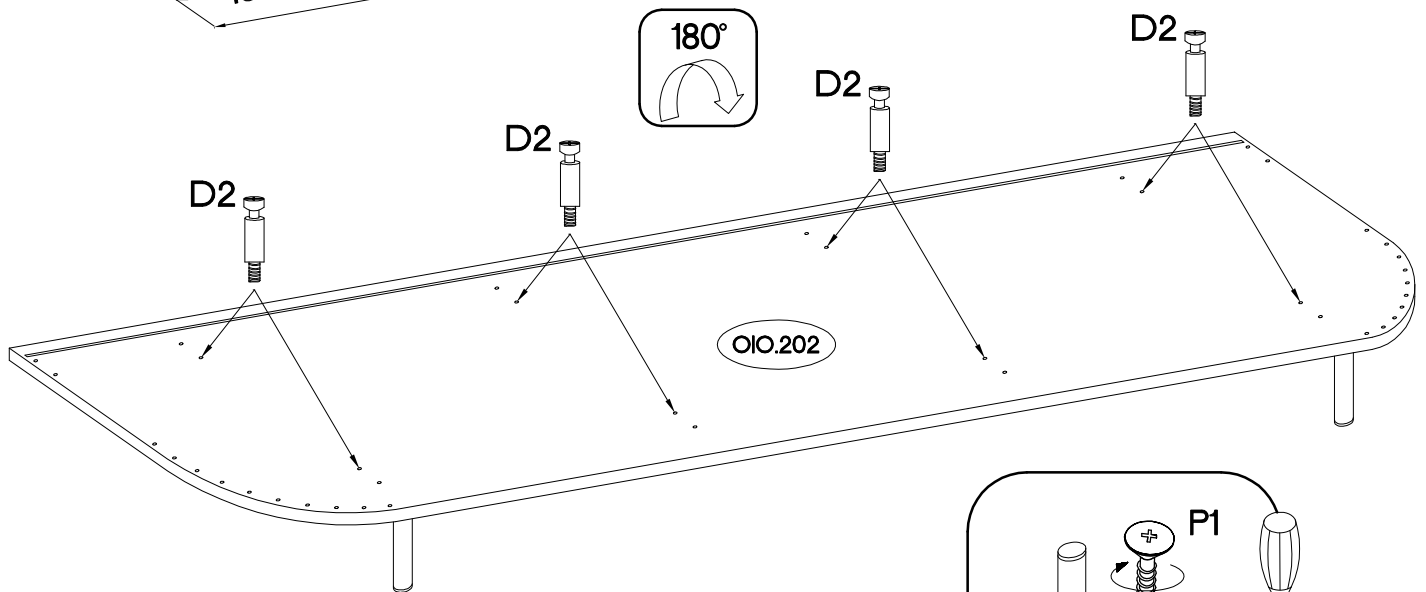
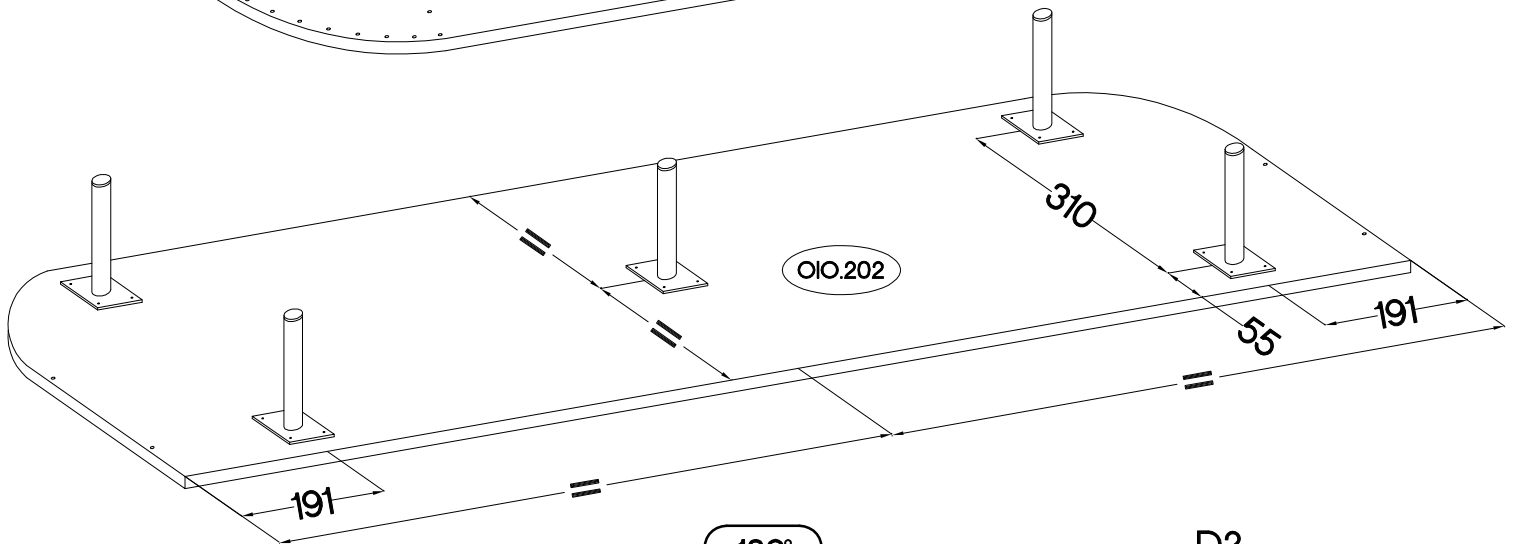
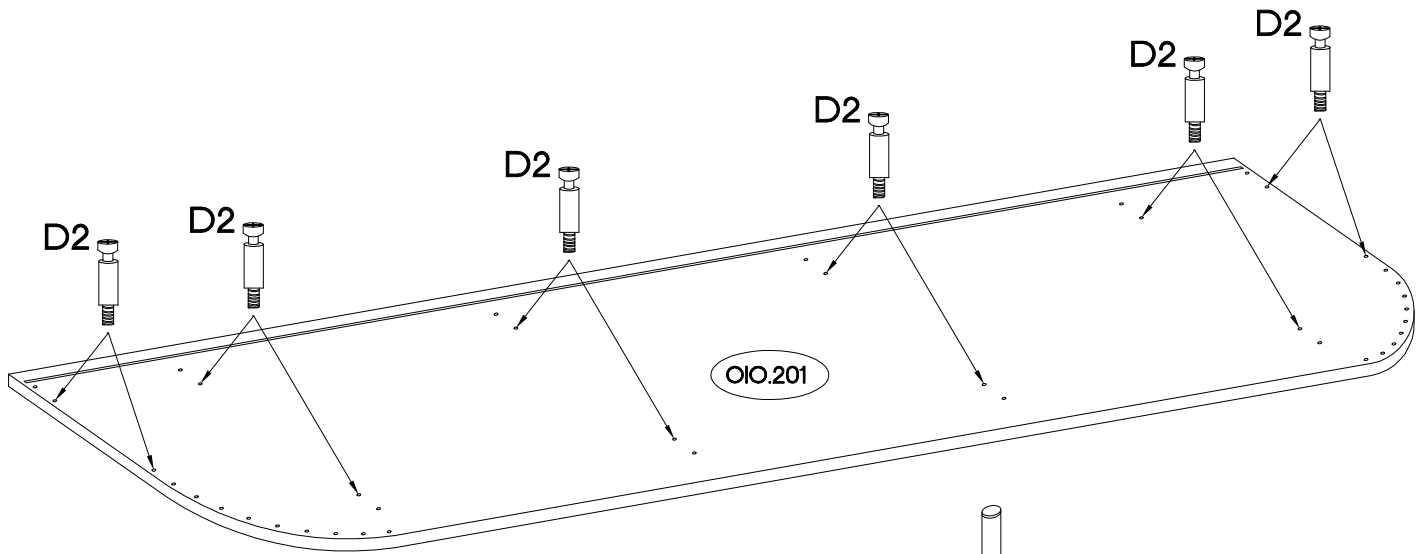
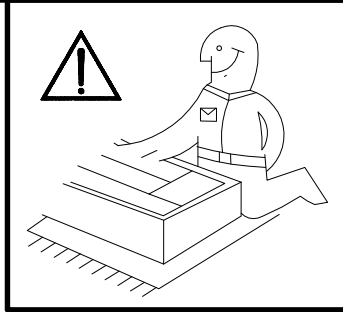
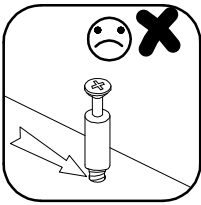
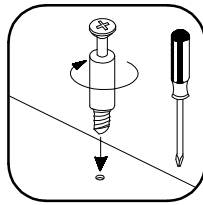

3

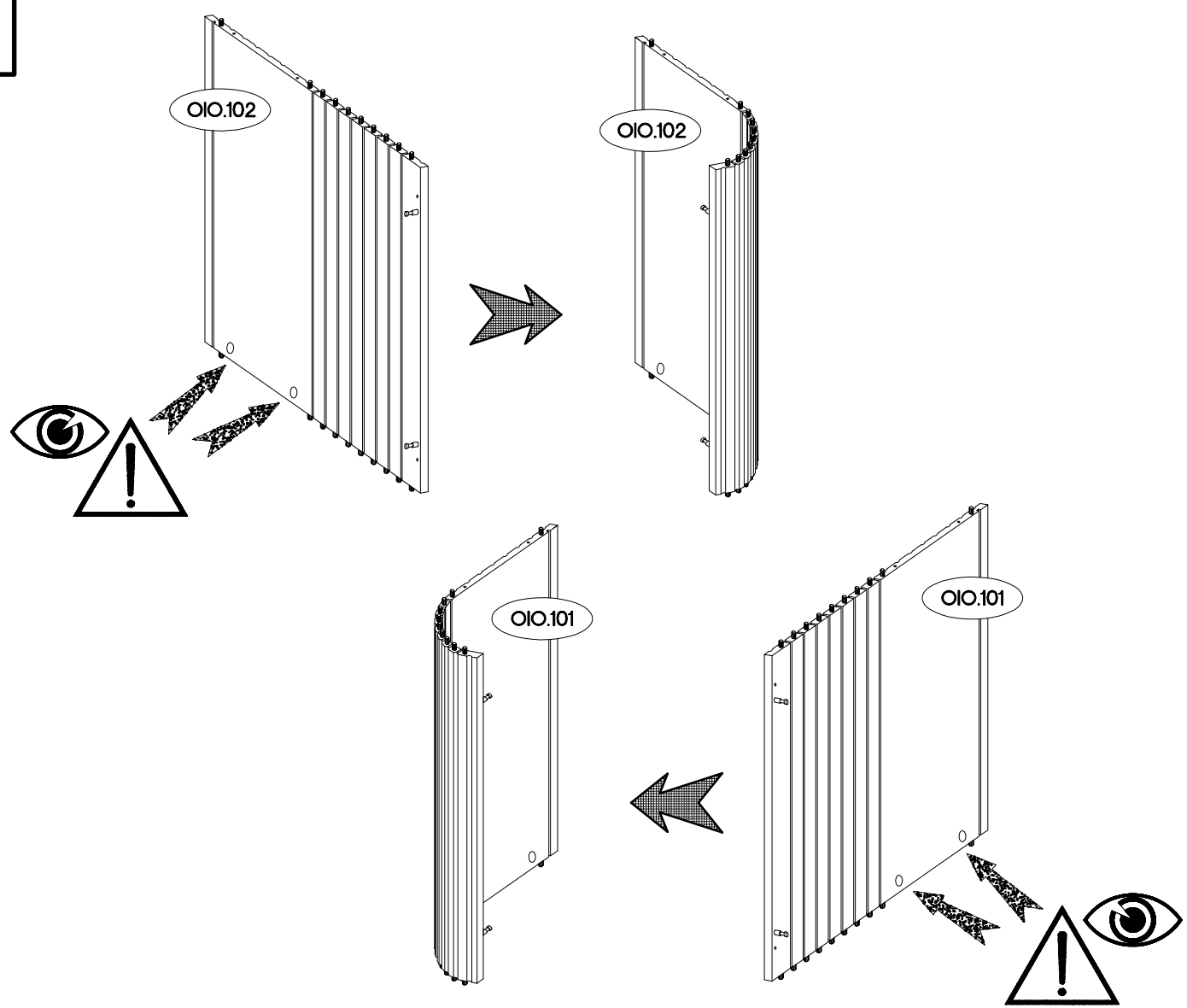

4

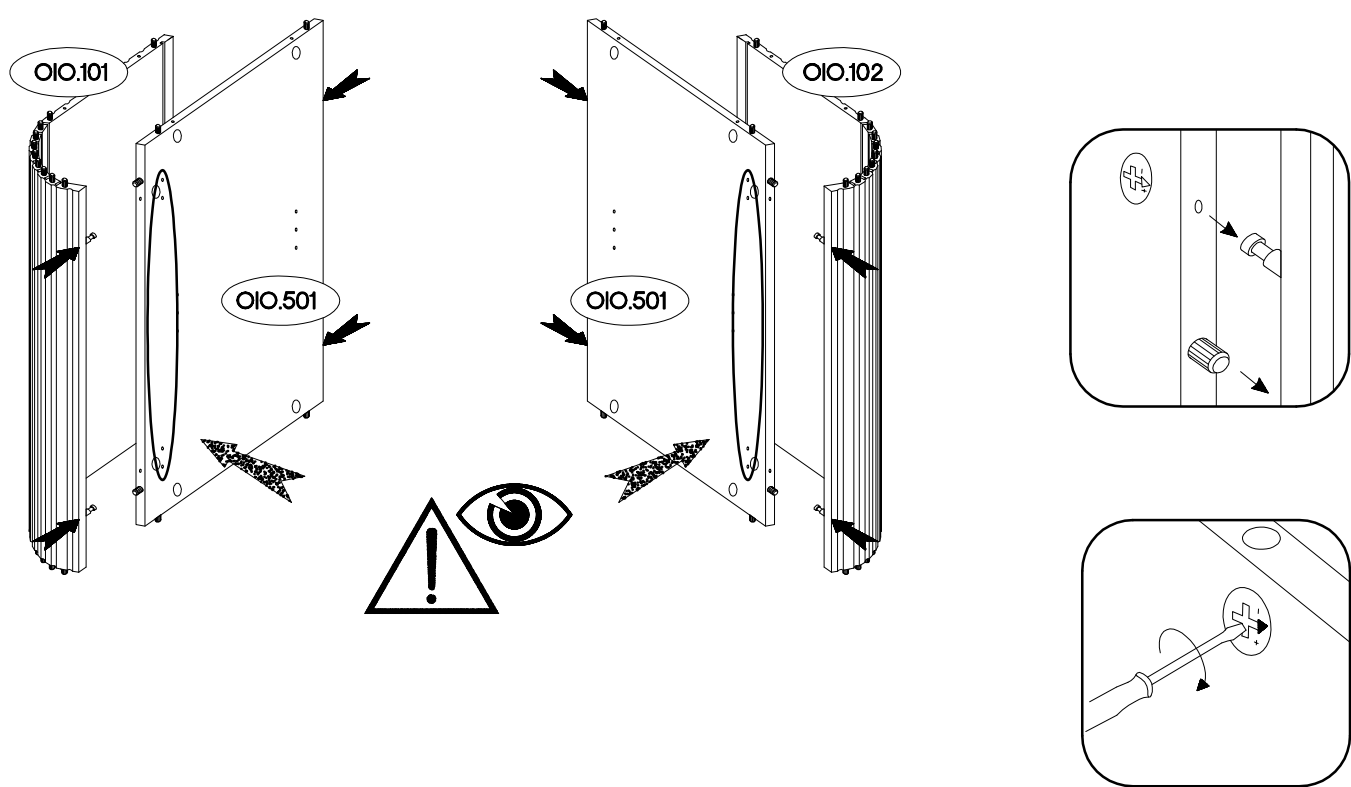

5

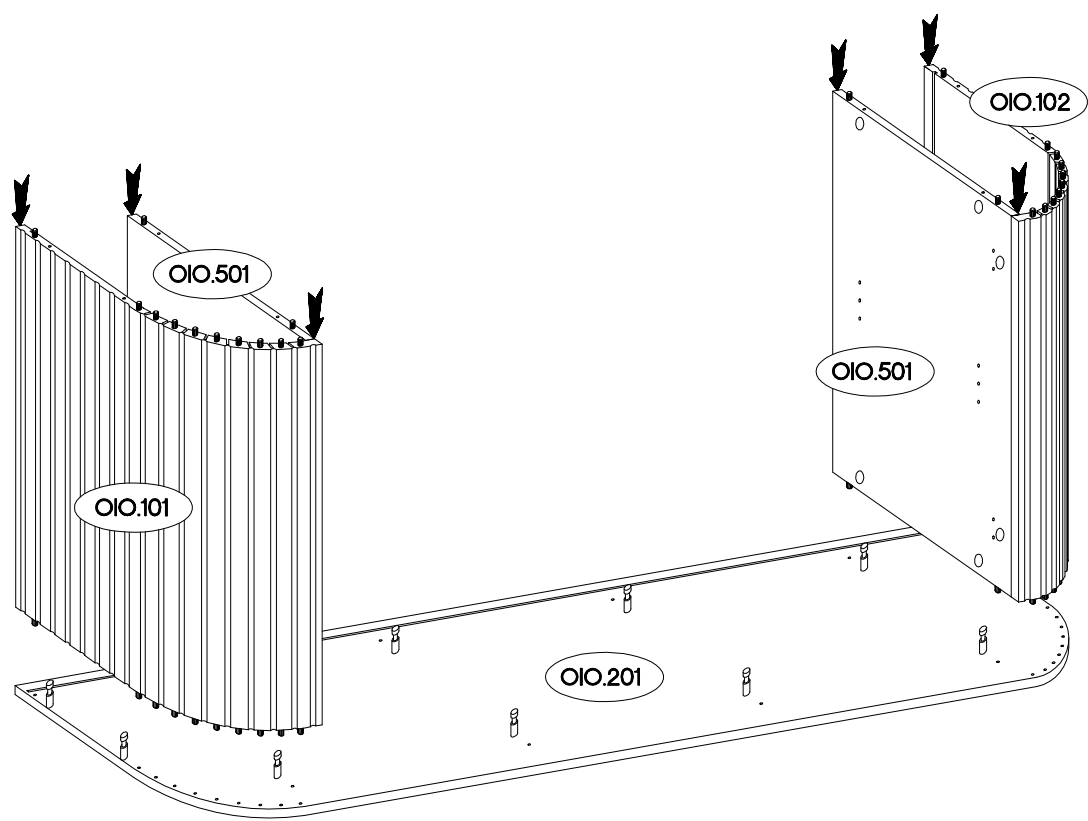



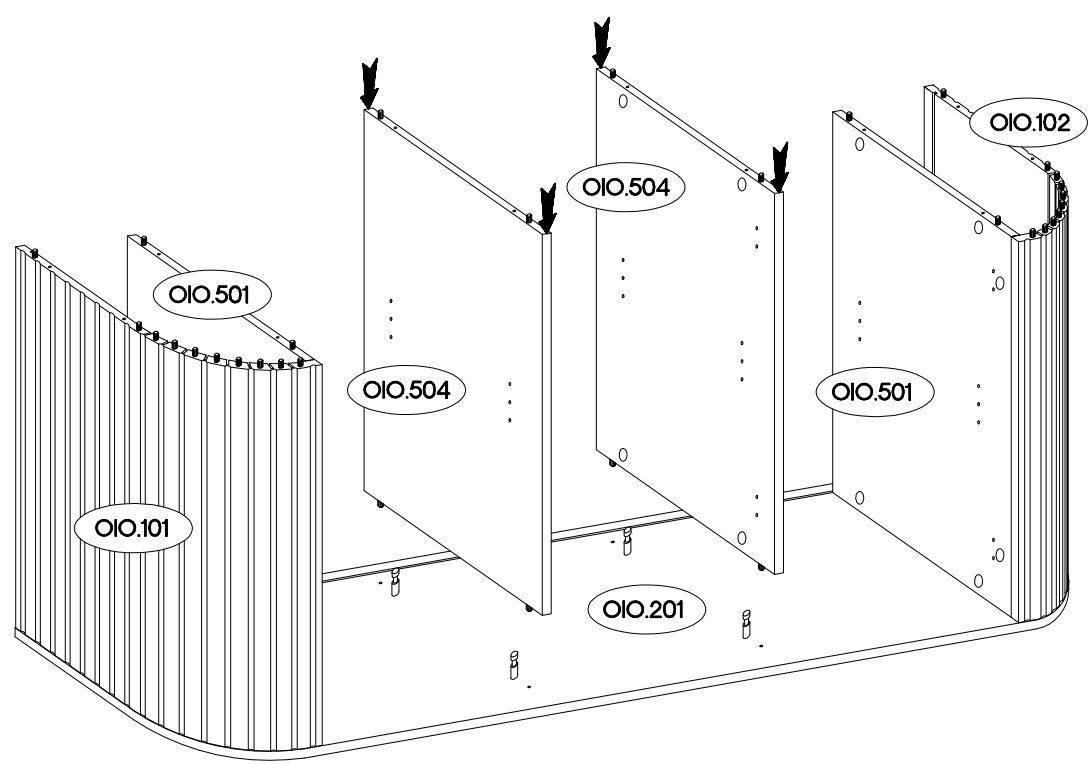
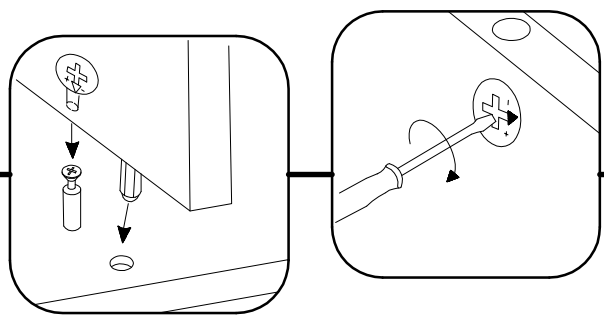

6

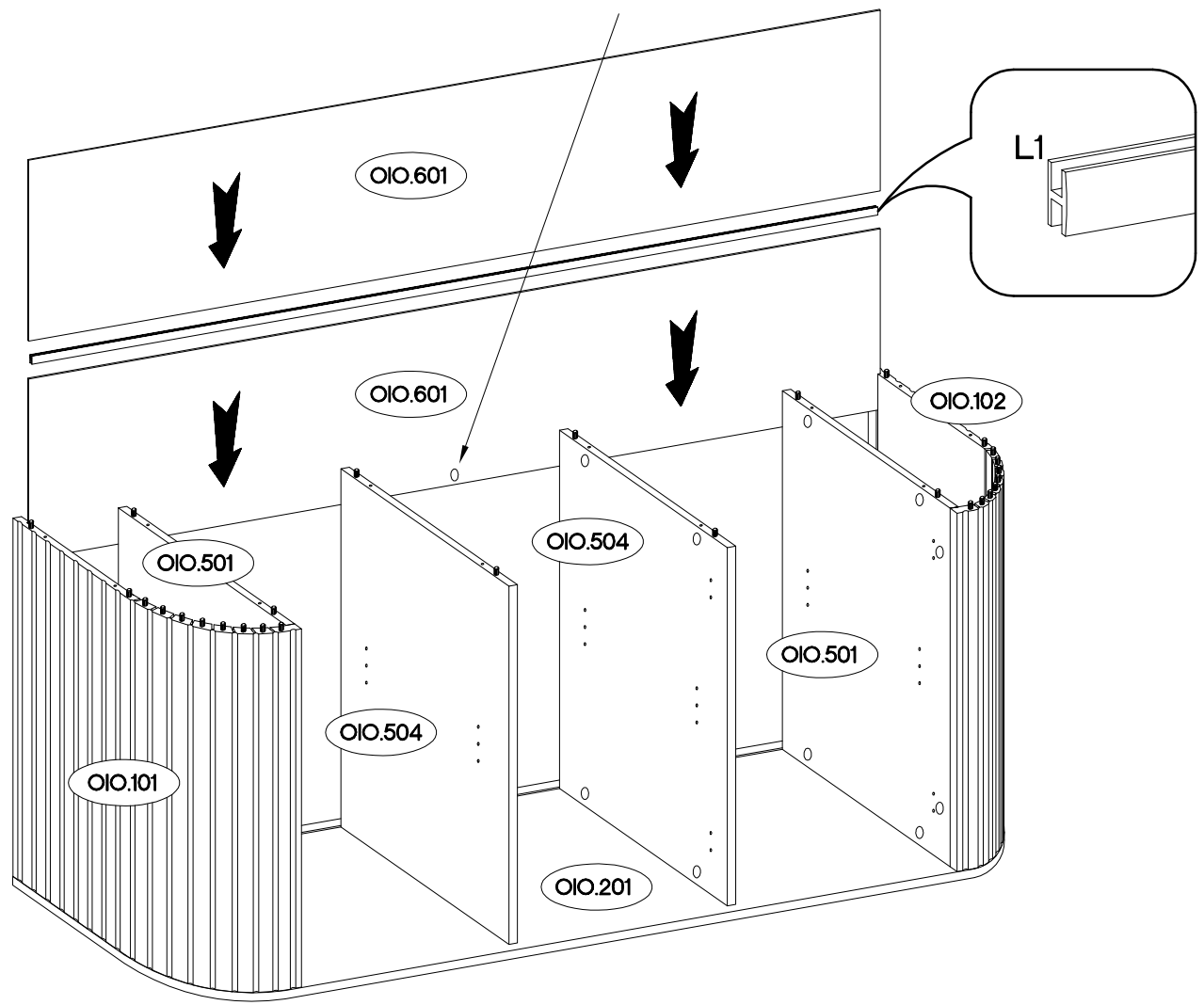
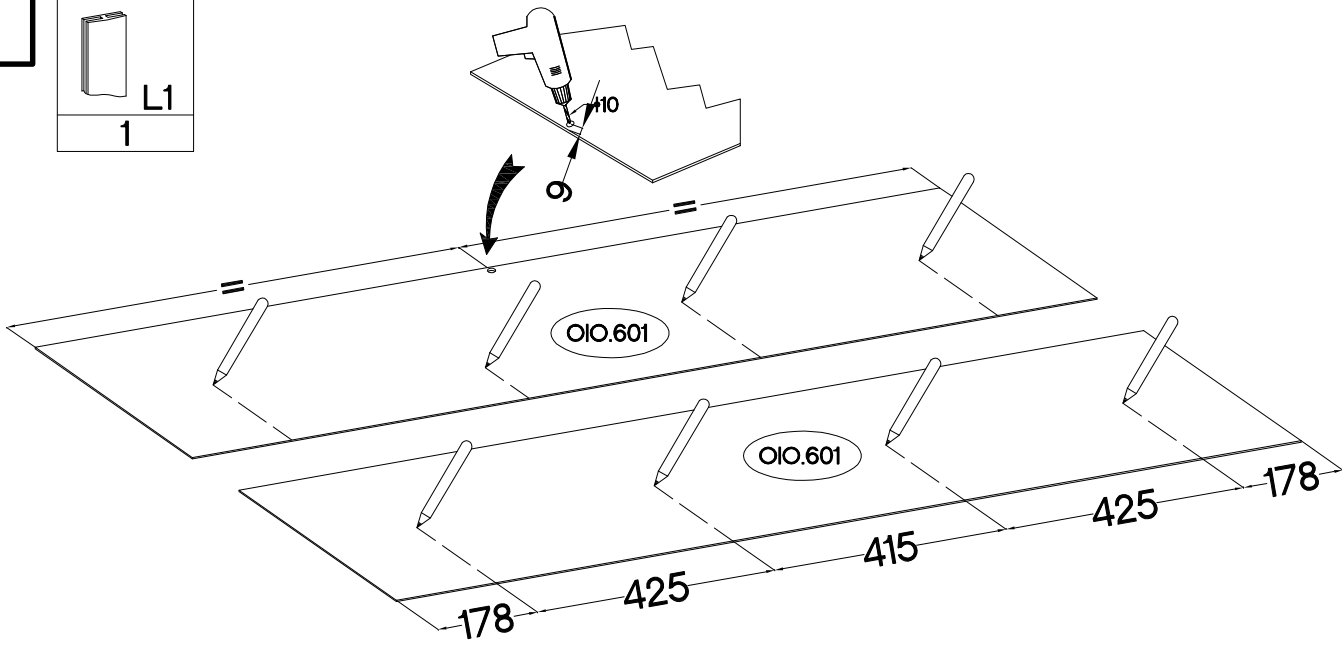
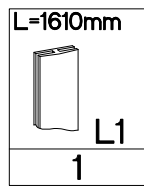

7



6.4 x 50mm  B 4	 O 1	 L 14	3.0x20mm  P7 16
--	--	---	--

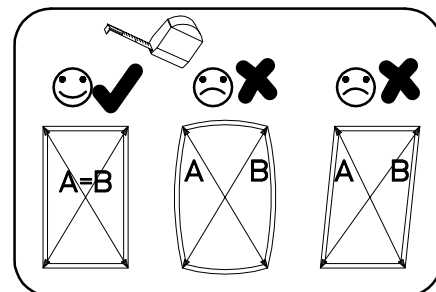
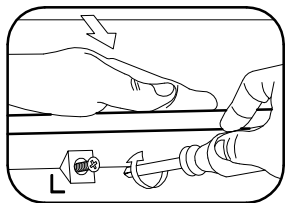
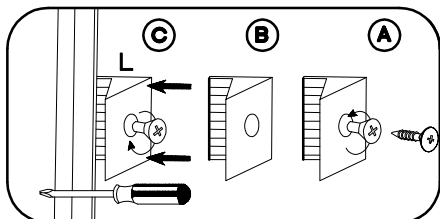
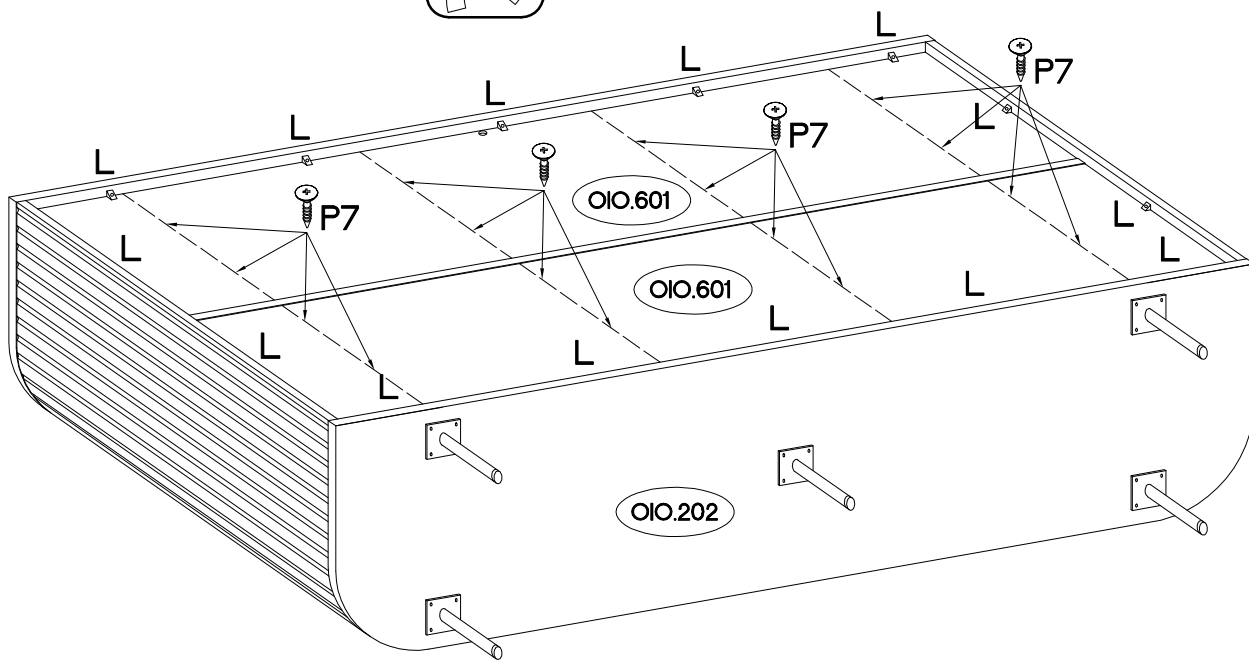
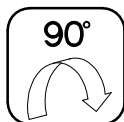
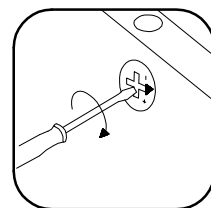
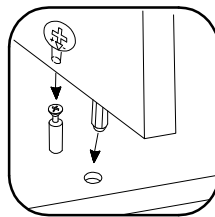
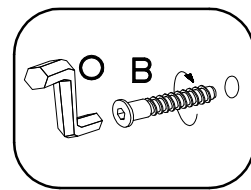
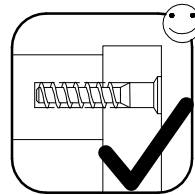
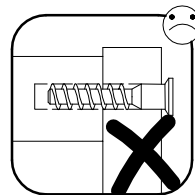
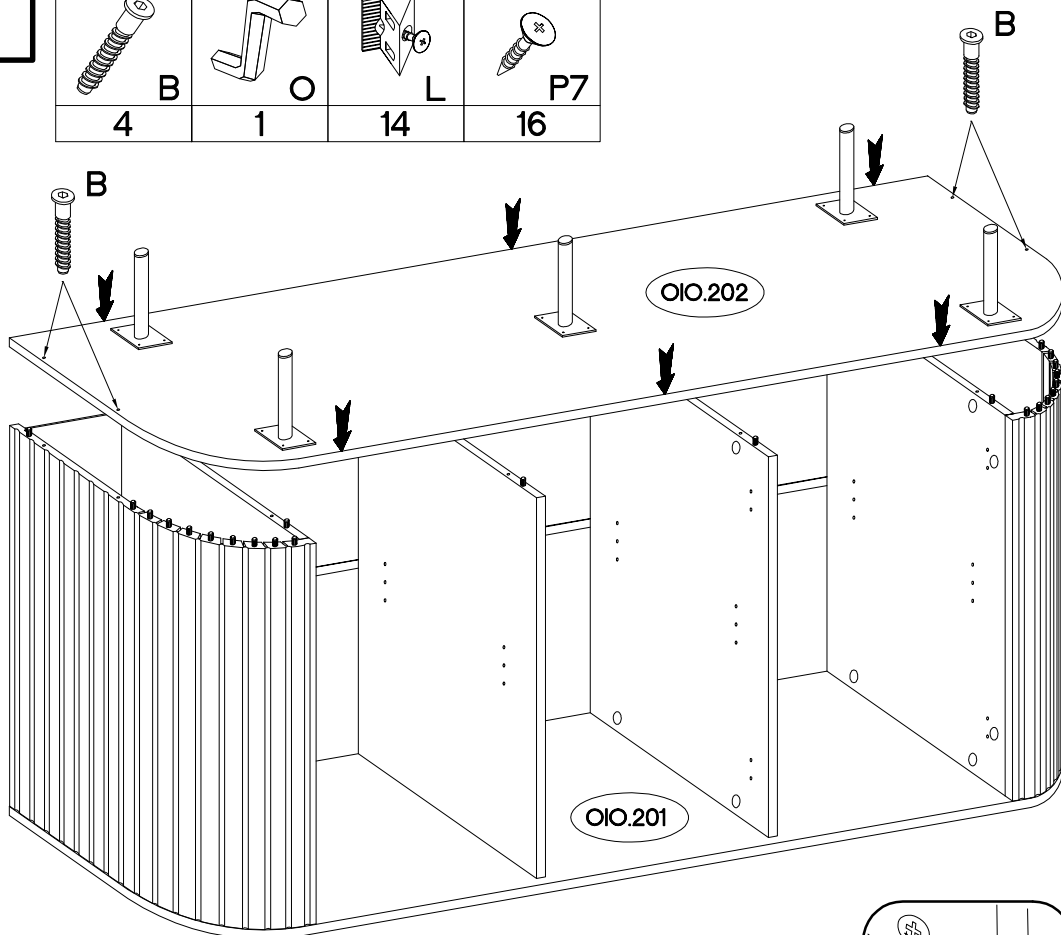

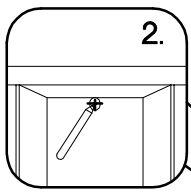



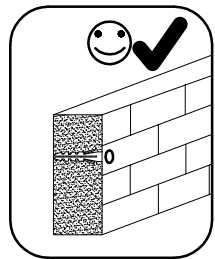
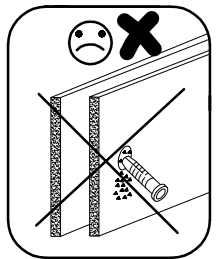
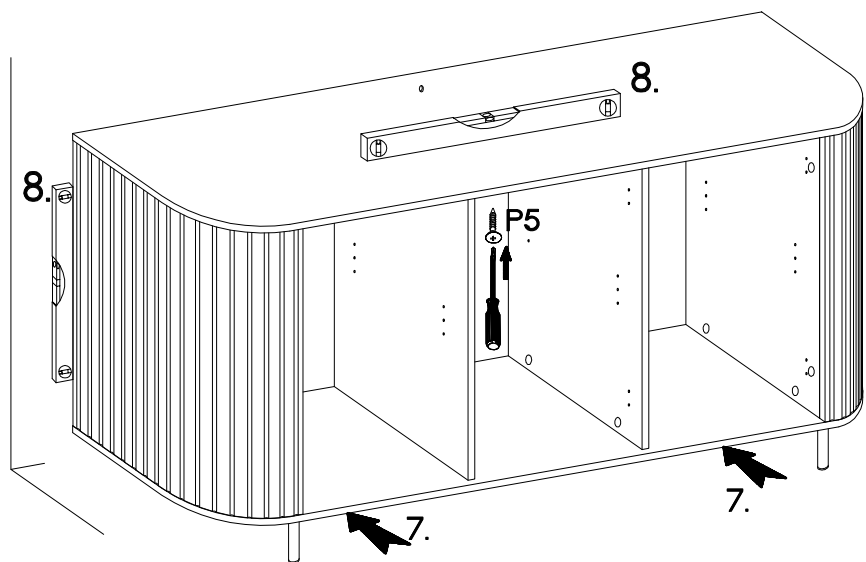
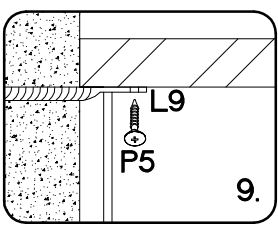
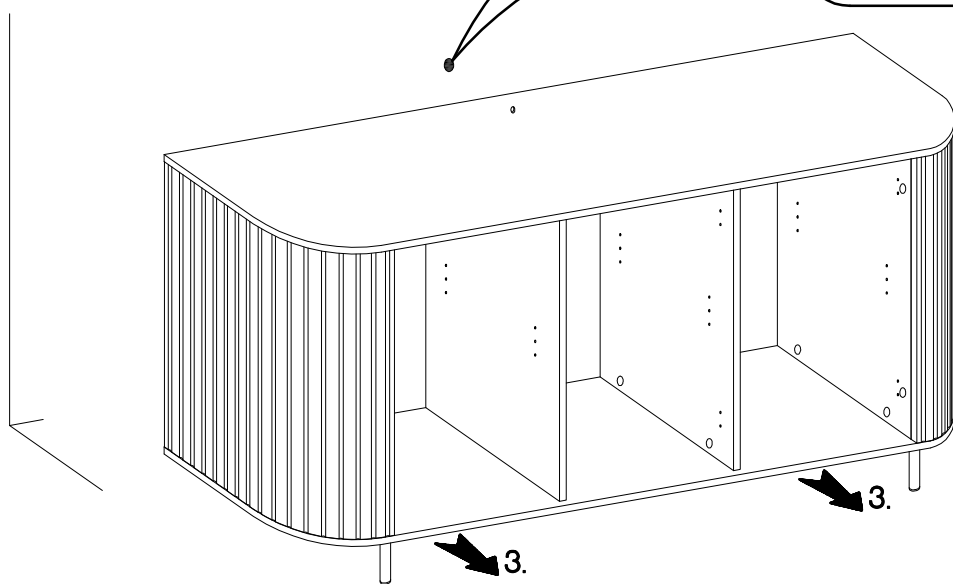
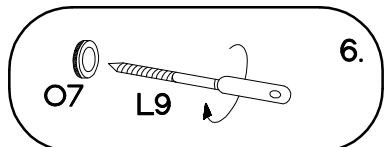
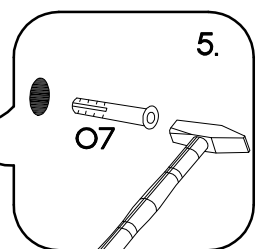
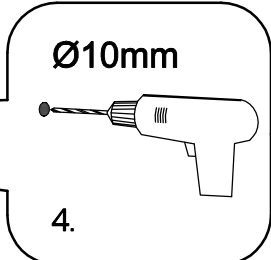
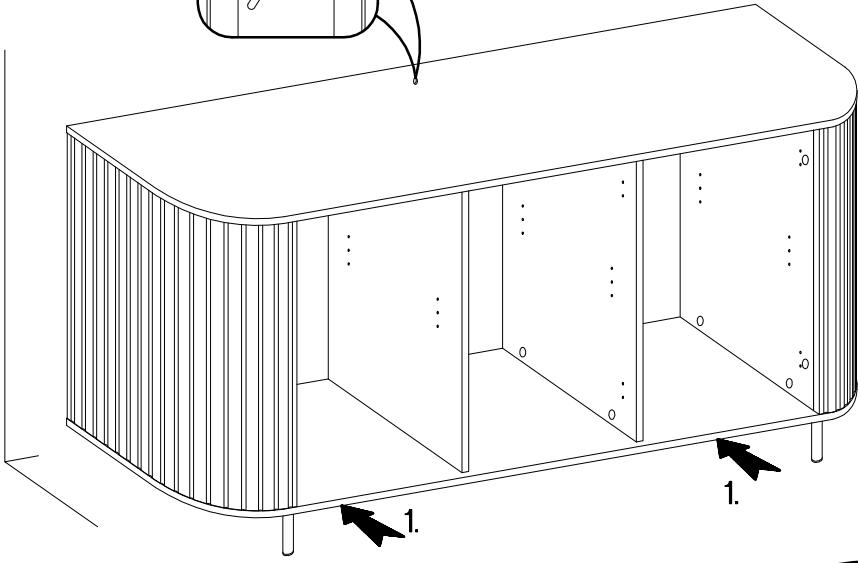

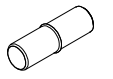
<p>+10x50mm</p> <p>Ø7</p> <p>1</p>	<p>+3.5x13mm</p> <p>L9</p> <p>1</p>	<p>+3.5x13mm</p> <p>P5</p> <p>1</p>
------------------------------------	-------------------------------------	-------------------------------------

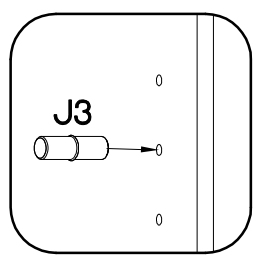
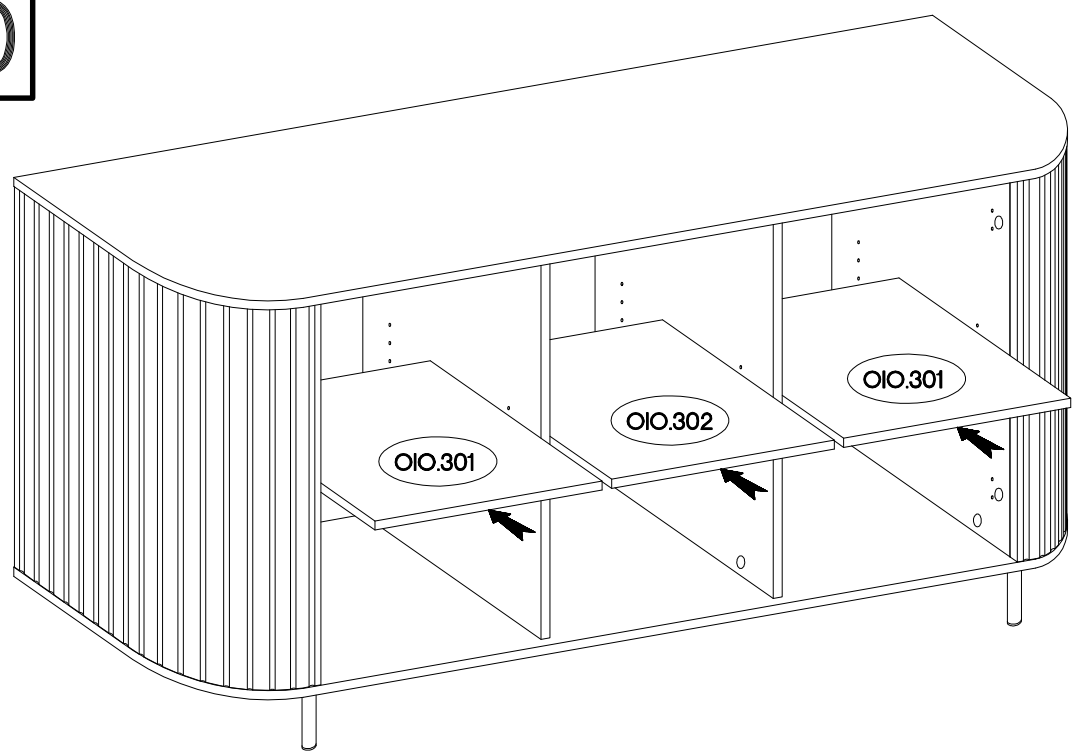

±5/16mm

J3
12

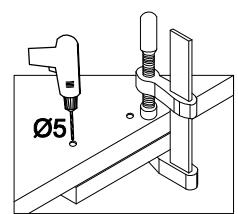
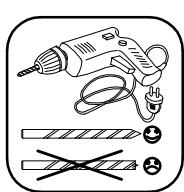
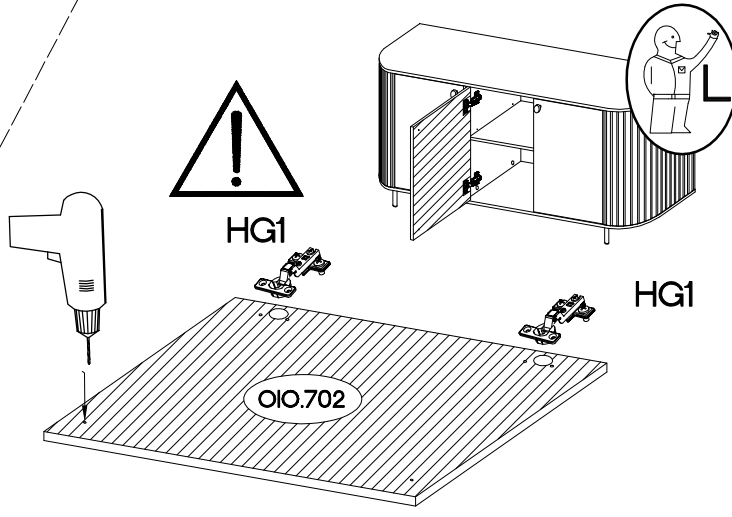
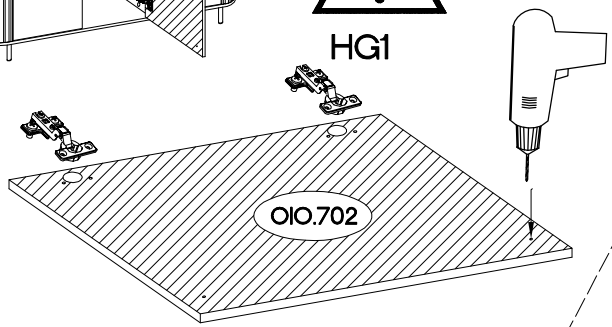
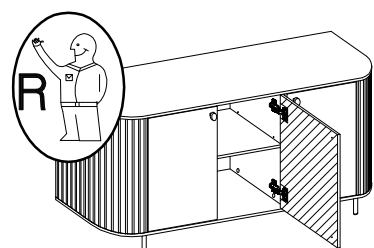
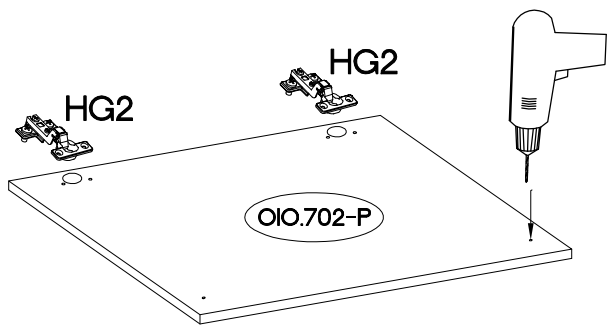
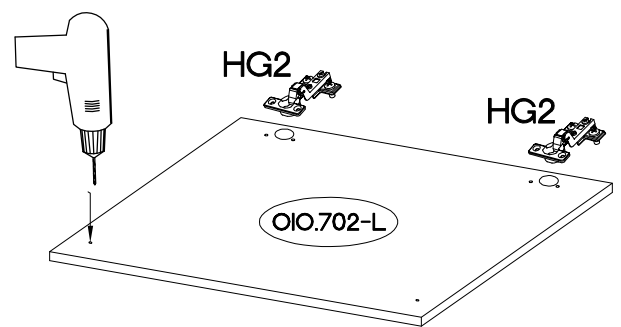
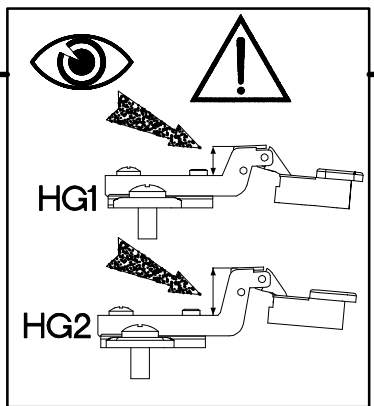
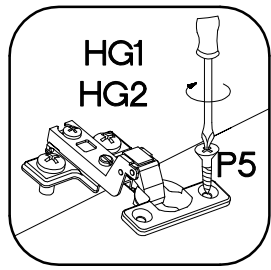

±35/16mm	±35/9mm	±3.5x13mm
		
[CD] HG2	[CD] HG1	P5
4	2	12

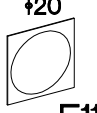

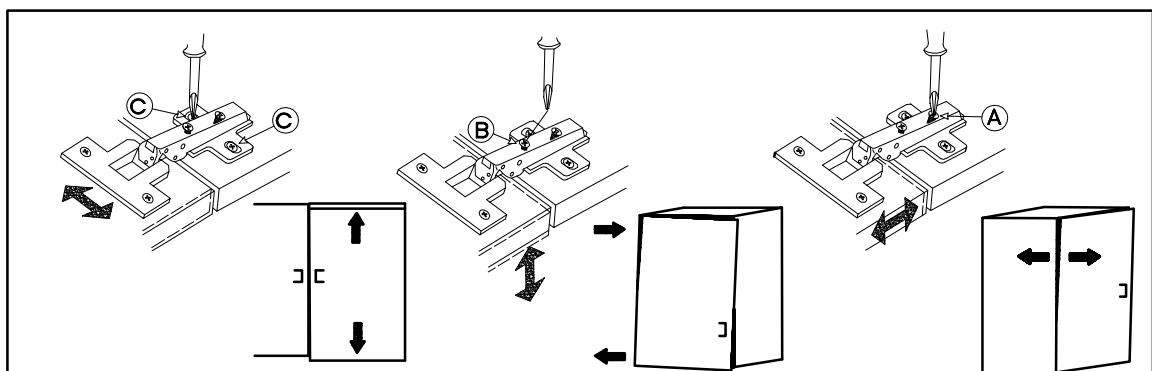
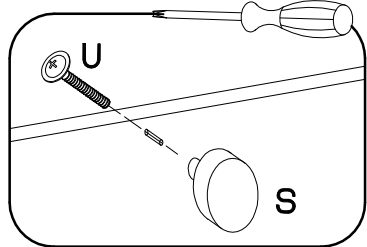
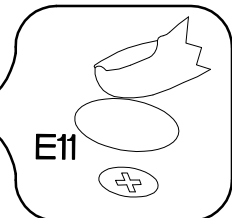
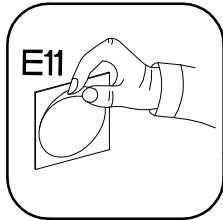
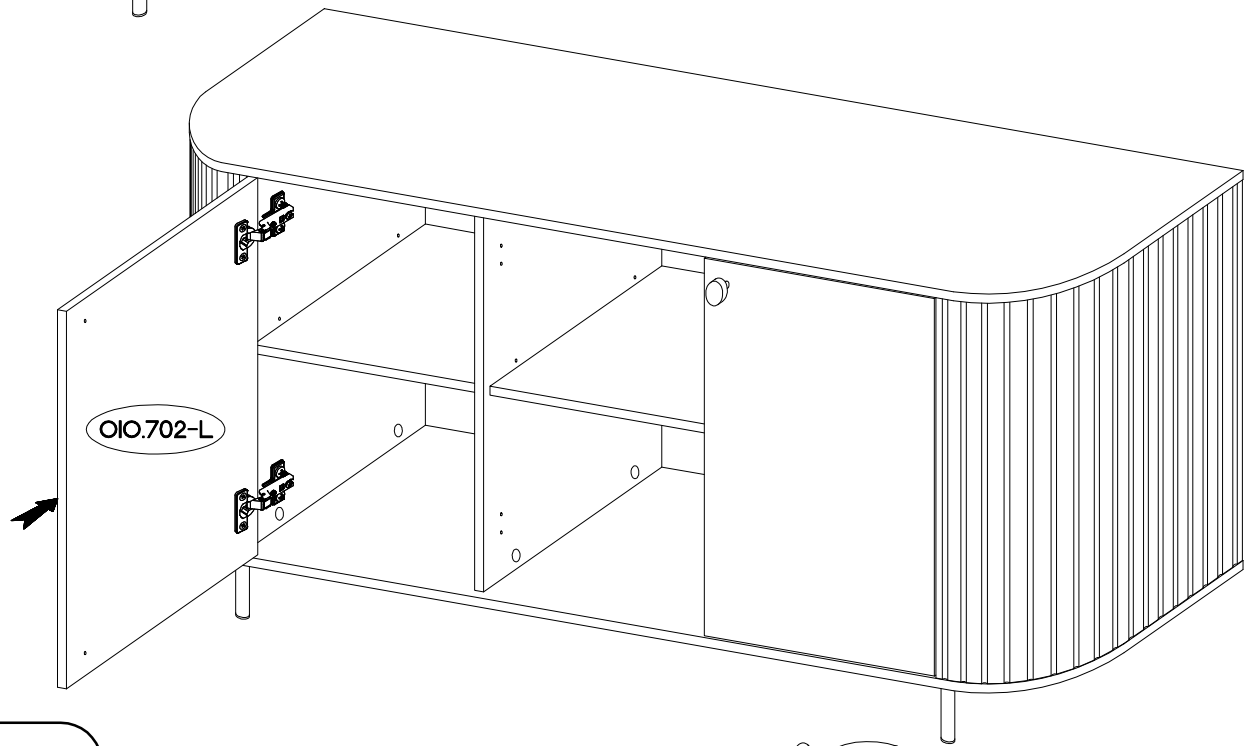
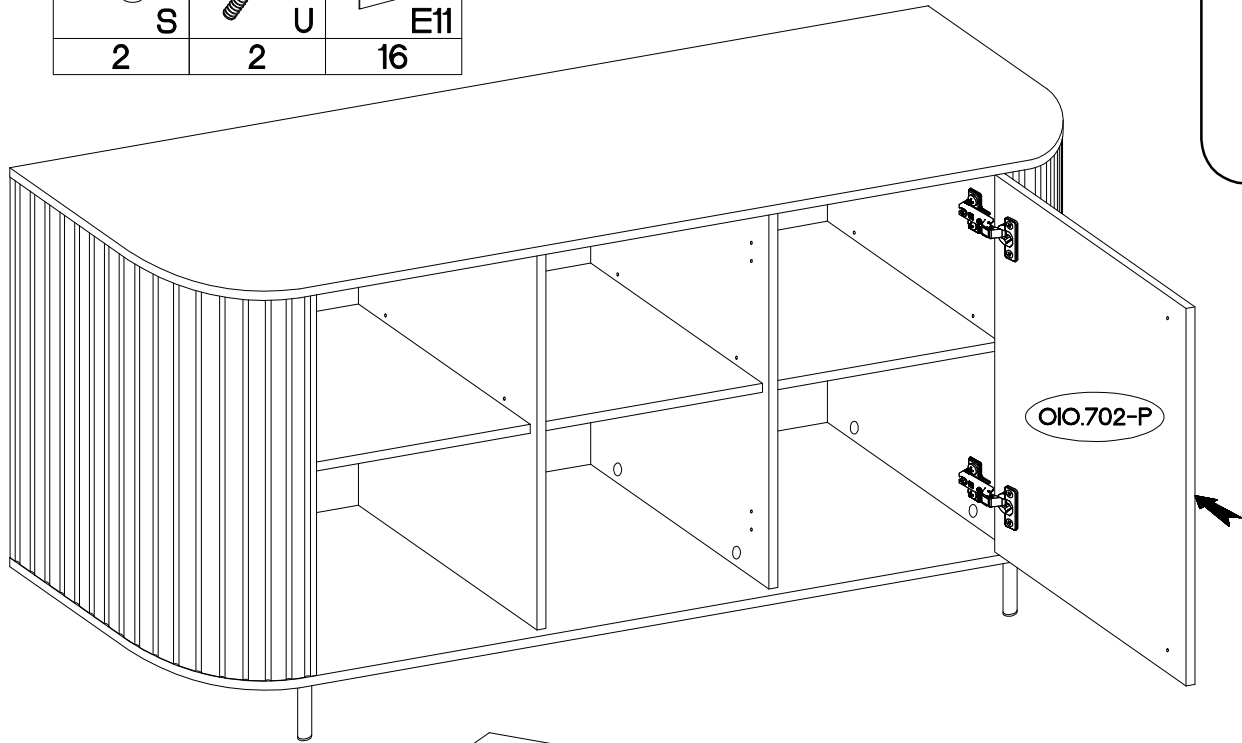
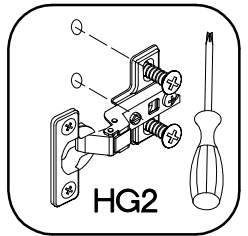
	M4x22mm	
S	U	E11
2	2	16



	M4x22mm
S	U
1	1

