

POSSINA

INSTRUCTION

No. of people required

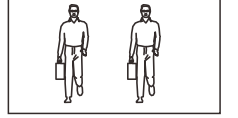





Note: Installation requires two workers to install, careful paint bump during installation.



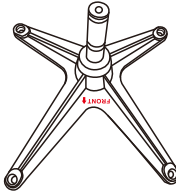
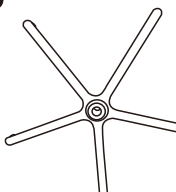
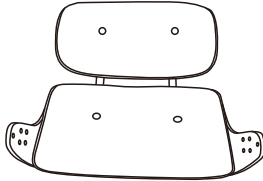
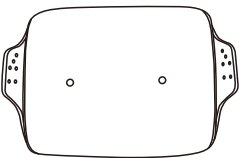
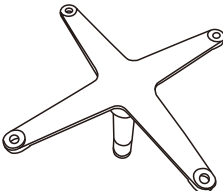
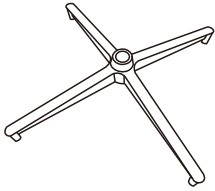
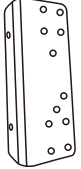
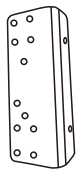

Chair

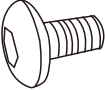
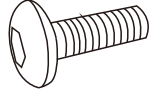
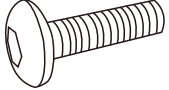
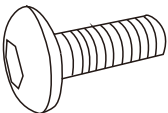

Parts List

<p>A</p>  <p>1PC</p>	<p>B</p>  <p>1PC</p>	<p>C</p>  <p>1PC</p>	<p>D</p>  <p>1PC</p>
<p>E</p>  <p>1PC</p>	<p>F</p>  <p>1PC</p>	<p>G-L</p>  <p>left arm bracket 1PC</p>	<p>G-R</p>  <p>right arm bracket 1PC</p>
<p>H</p>  <p>1PC</p>	<p>I-L</p>  <p>left arm bracket 1PAIR</p>	<p>I-R</p>  <p>right arm bracket 1PAIR</p>	

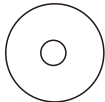
Hardware List

<p>J</p>  <p>M6x10mm 22+2PCS</p>	<p>K</p>  <p>M6x25mm 4+1PCS</p>	<p>L</p>  <p>M6x30mm 8+2PCS</p>	<p>M</p>  <p>M8x20mm 1PC</p>
<p>N</p>  <p>M6x18mm 12+2PCS</p>	<p>O</p>  <p>M8x40mm 1PC</p>	<p>P</p>  <p>9PCS</p>	<p>Q</p>  <p>1PC</p>

- 1** Iron plates (Part G-L and Part G-R) are fixed on the Backrest (Part C) using (Part J) and tightened by 70%

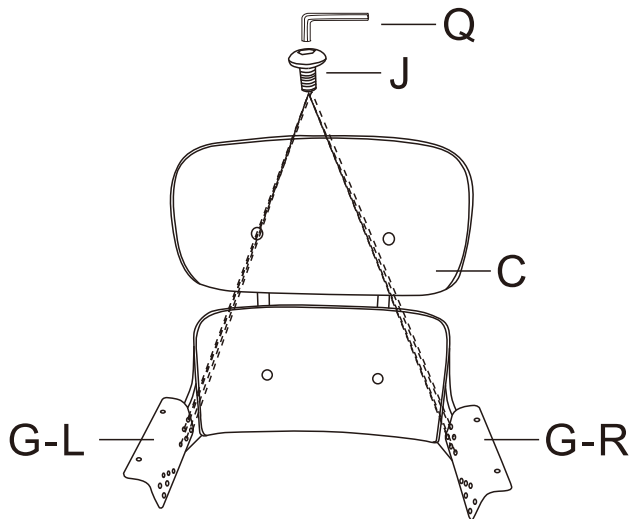

- 2** Install the iron plate (Part G-L and Part G-R) onto the seat (Part H) using (Part J) and tighten it by 70% first. Then (Part J) tighten and lock all screws from step 1 and step 2 to 100%

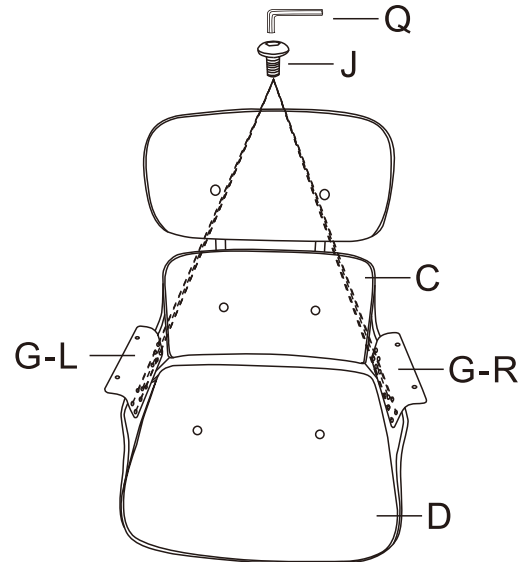

- 3** Attach armrest (Part I) and tighten up all the bolts.

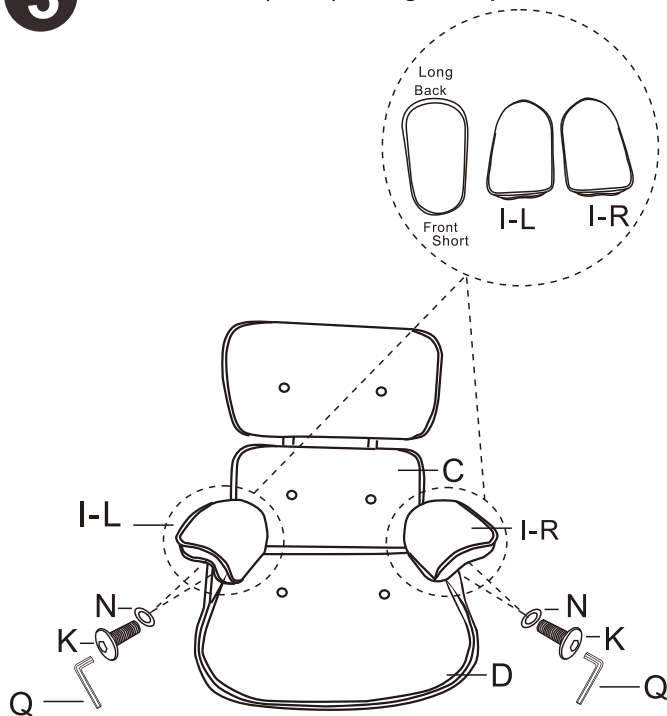

- 4** Install (Part A) onto the seat (Part H) using (Part L and Part N), tighten 70% first, align the holes, and immediately install 100%

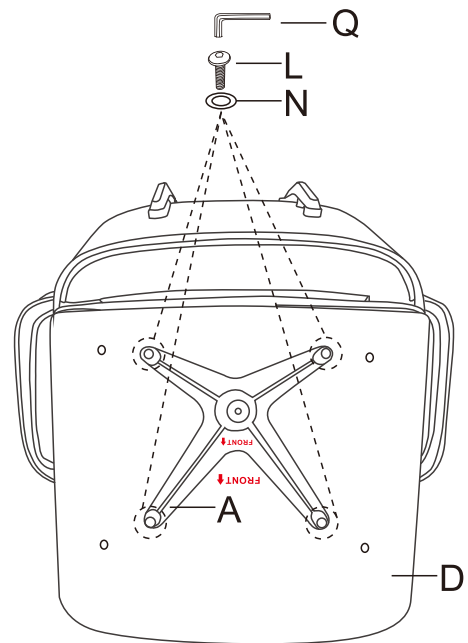

5 Install (Part B) onto (Part A) and install the foot pins (Part P)

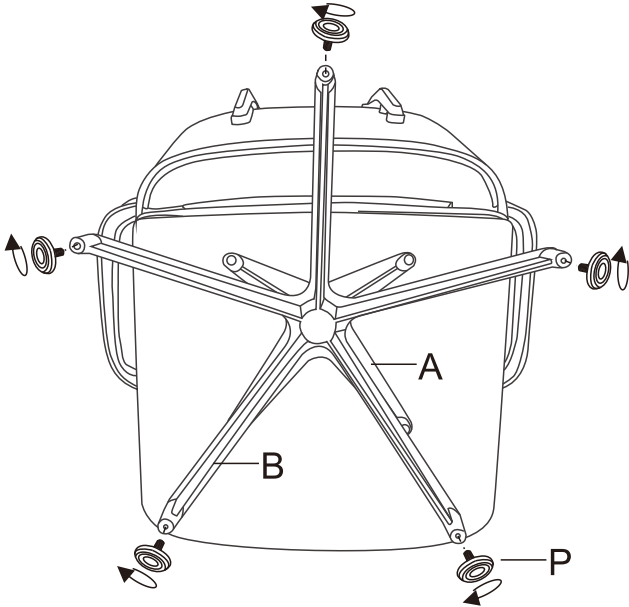

6 Install (Part O and Part M) onto (Part B)

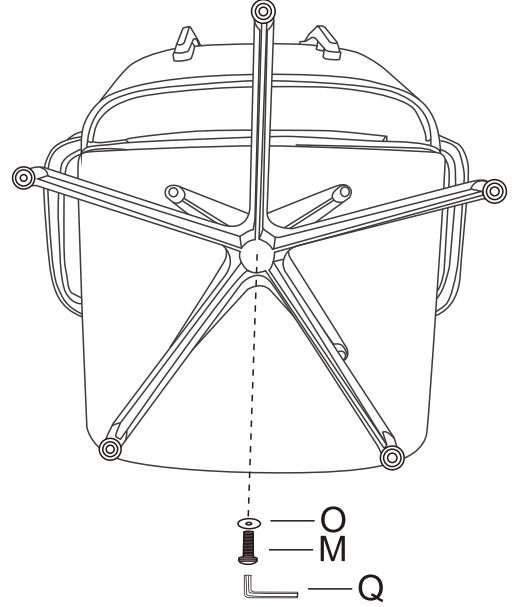

7 Install (Part E) to (Part F) completely.

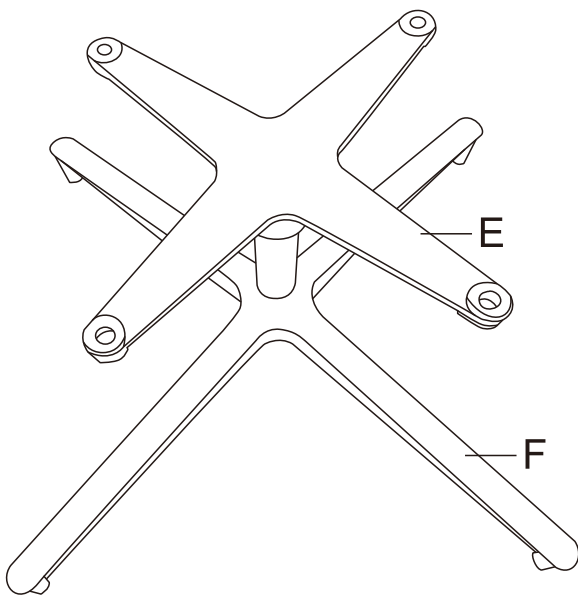

8 Install the foot pins (Part P)

