

30 min

TYP 201

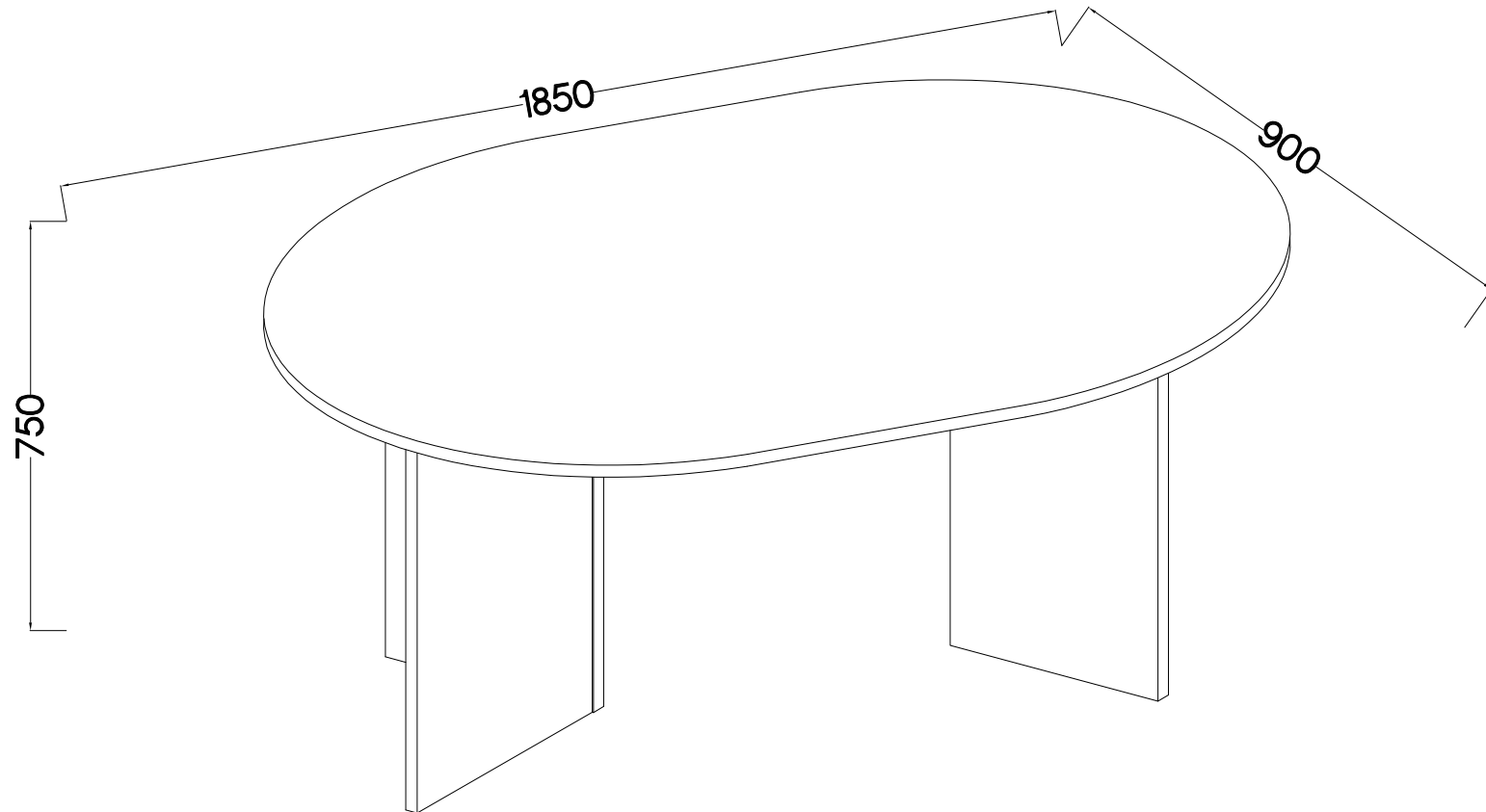

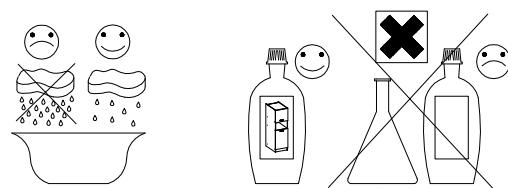

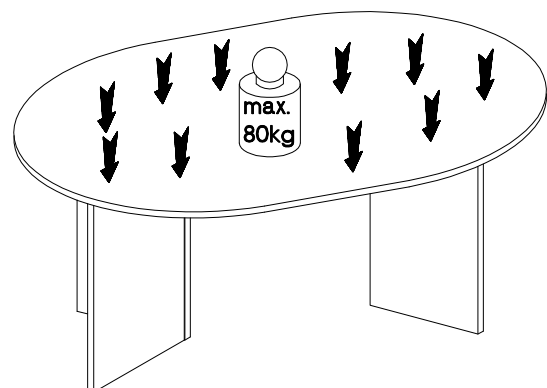
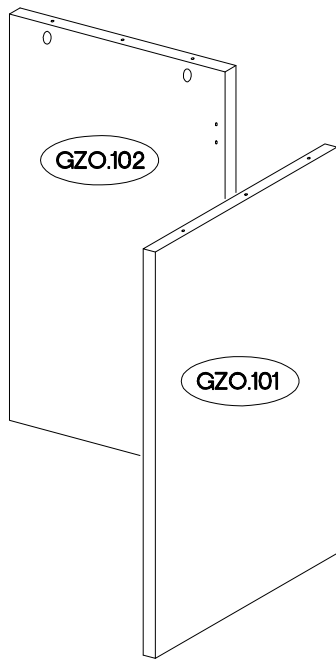
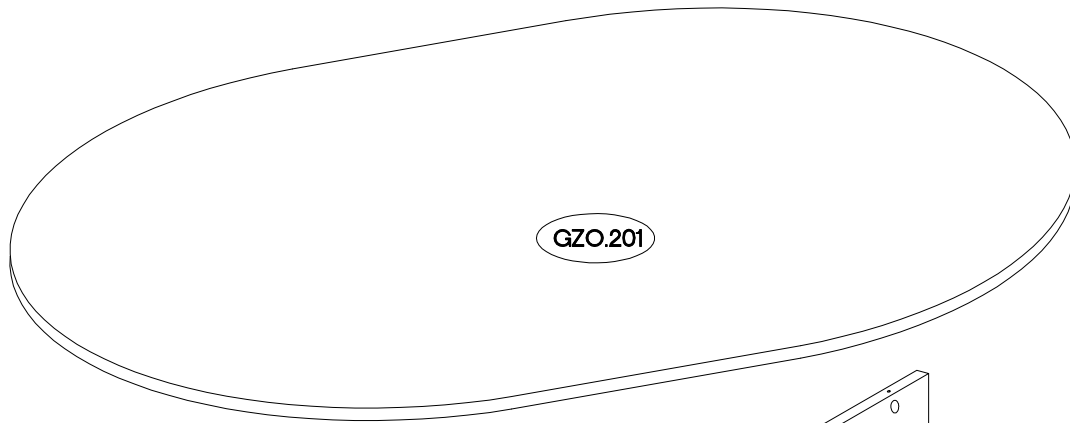

†8x30mm	†15/12mm	L=20mm	†20	50x20mm
A	C	D2	E11	E18
10	12	12	12	8

ISM-GZO-001



	Ersatzteil Nummer	Dimension
	GZO.101 x2	717x370x22
	GZO.102 x2	717x394x22
	GZO.201	1850x900x22

<p>∅8x30mm</p>  <p>A</p> <p>10</p>	<p>∅15/12mm</p>  <p>C</p> <p>12</p>	<p>L=20mm</p>  <p>D2</p> <p>12</p>	<p>50x20mm</p>  <p>E18</p> <p>8</p>
--	---	--	---

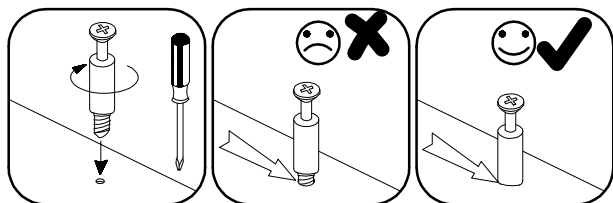
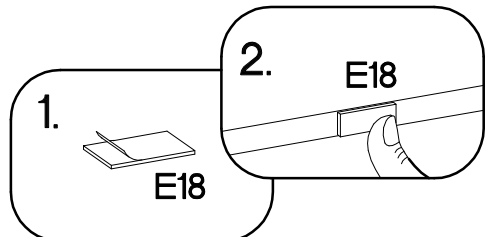
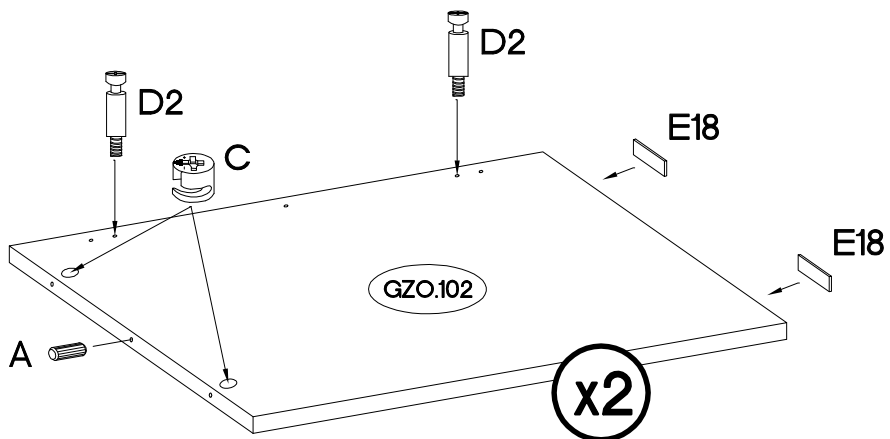
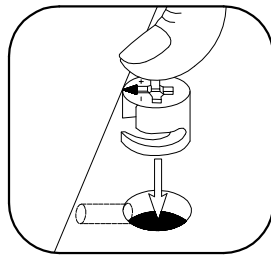
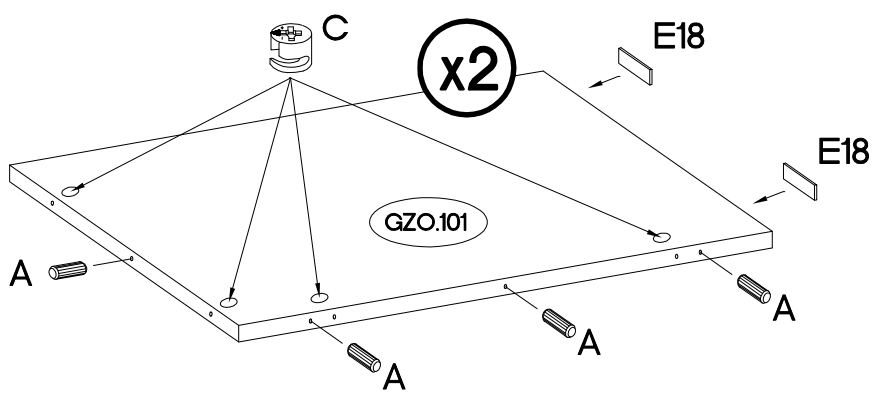
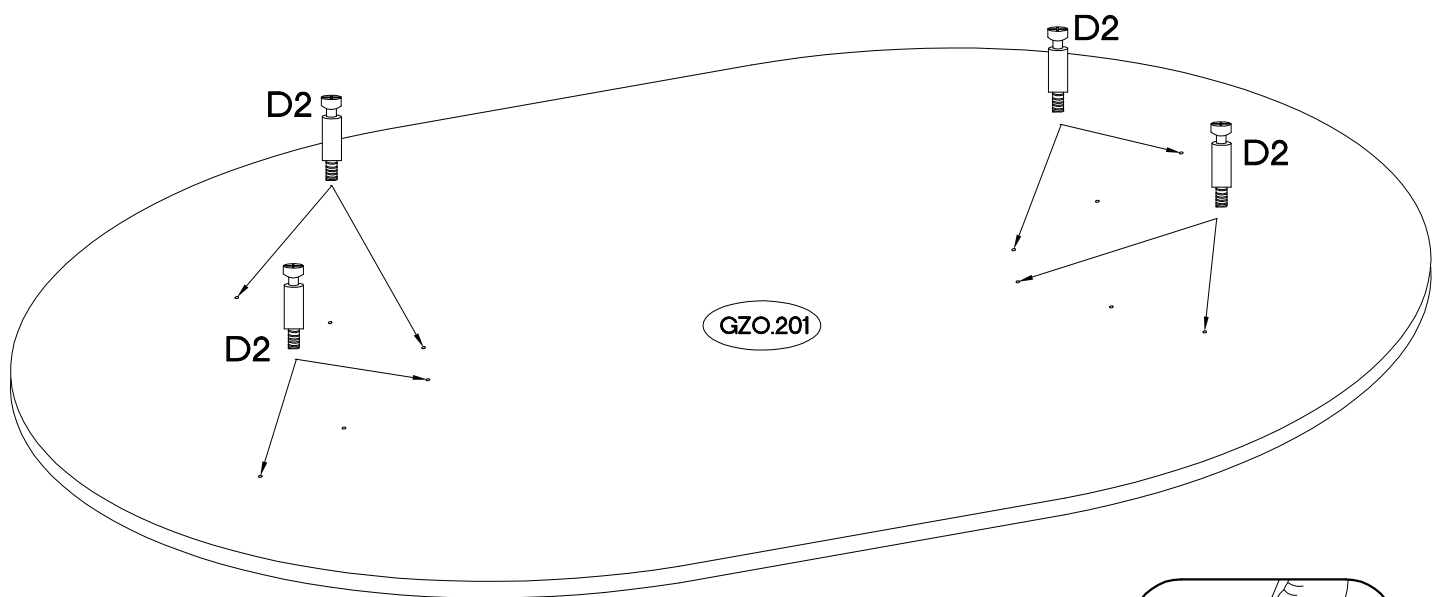
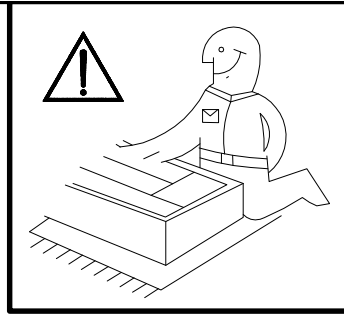
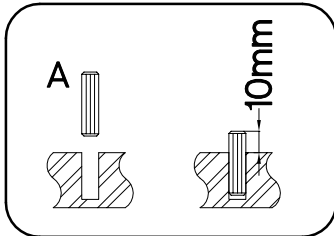

2

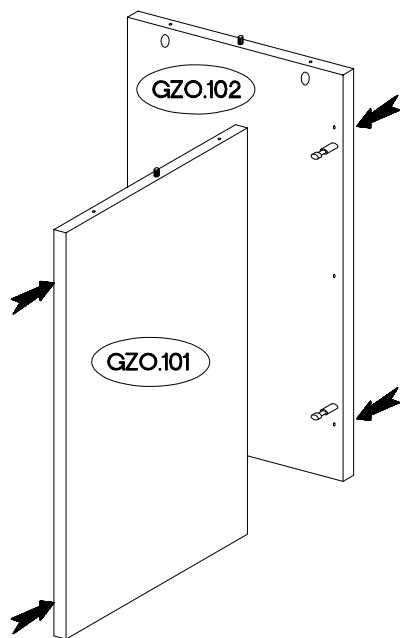

x2

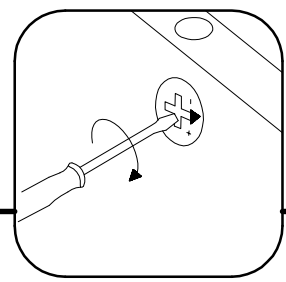
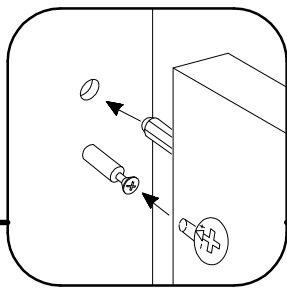
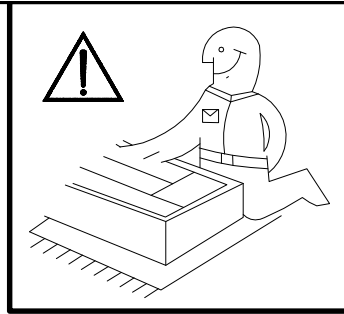

3

+20

12

