

**Wardrobe Santi/Bono/Calia**  
Video Assembling Instruction

**Kleiderschrank Santi/Bono/Calia**  
Video Montageanleitung

**Szafa Santi/Bono/Calia**  
Video Instrukcja montażu



**Wardrobe Santi/Bono/Calia**  
Video Assembling Instruction

**Kleiderschrank Santi/Bono/Calia**  
Video Montageanleitung

**Szafa Santi/Bono/Calia**  
Video Instrukcja montażu



**PL> INSTRUKCJA MONTAŻU**  
**D >MONTAGEANLEITUNG**  
**GB>ASSEMBLY INSTRUCTIONS**

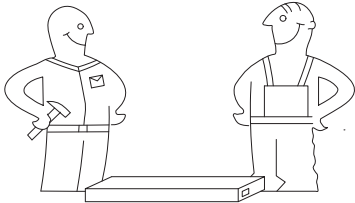
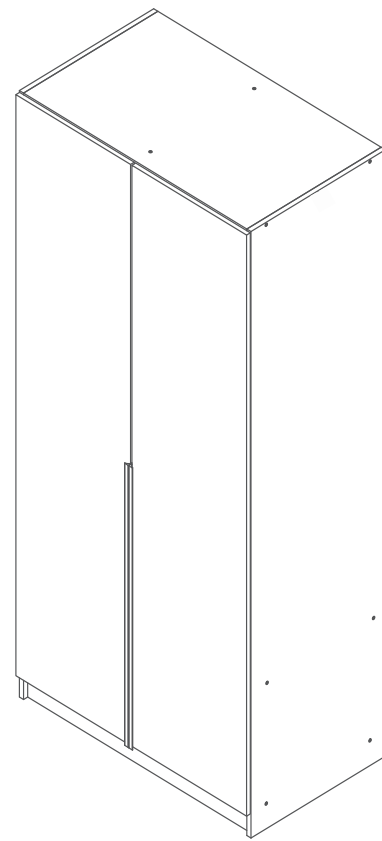

Tools required narzędzia wymagane Werkzeuge erforderlich

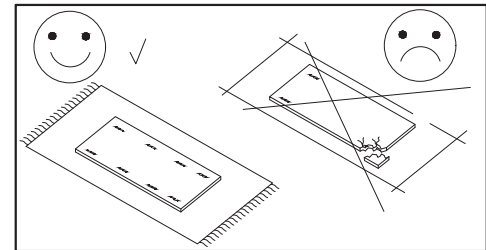
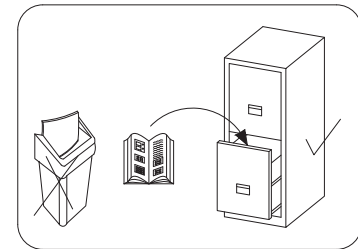
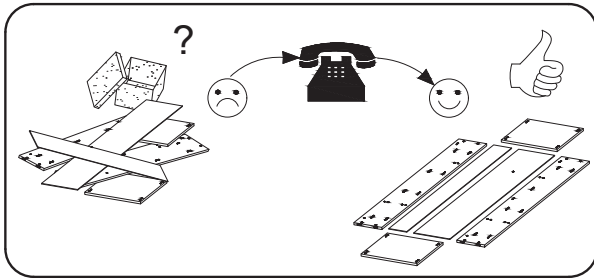
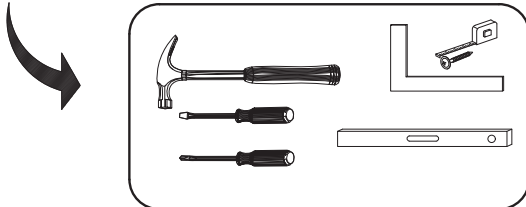

## Uwaga / Achtung / Caution

**PL>**Czyszczenie należy wykonać wyłącznie za pomocą ściereczki lub lekko nawilżonego ręcznika.  
 Nie stosować środków czyszczących do szorowania.

Szanowny kliencie, jeśli podczas montażu stwierdzisz uszkodzenie lub brak części, proszę podaj jej kod alfanumeryczny lub zaznacz ją na instrukcji montażu i prześlij wraz z protokołem reklamacyjnym

**D >**Bitte nur mit einem Staubtuch oder leicht feuchtem Lappen reinigen. Keine scheuerenden Putzmittel verwenden.

Sehr geehrter kunde, sollte ein teil fehlen oder beschädigt sein, kreuzen sie dies bitte deutlich auf der montageanleitung an und schicken sie die montageanleitung mit ein.



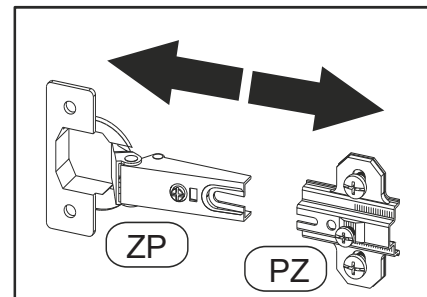
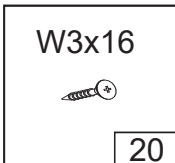
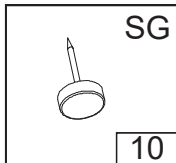
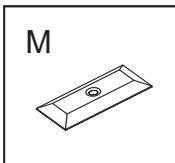
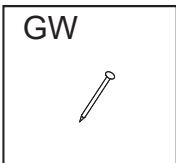
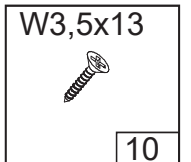
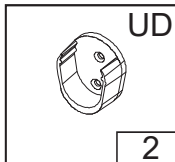
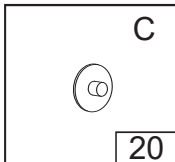
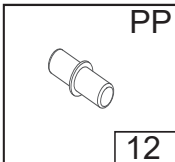
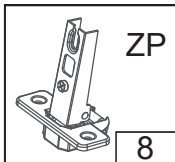
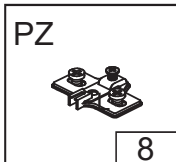
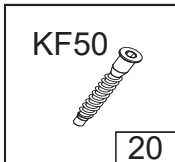
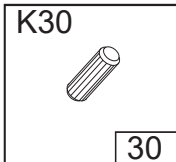
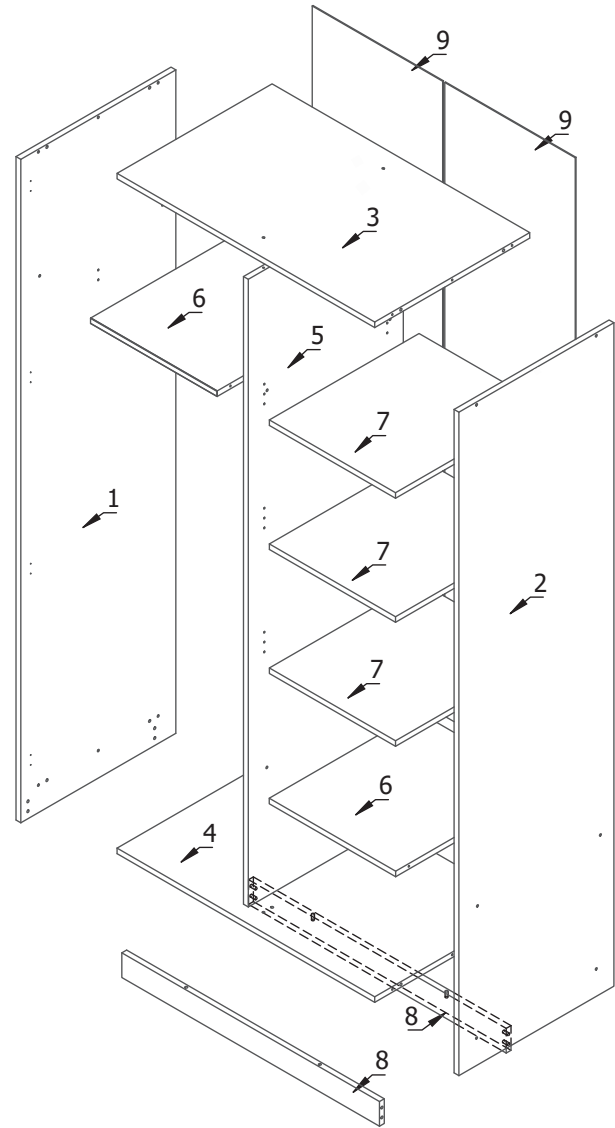
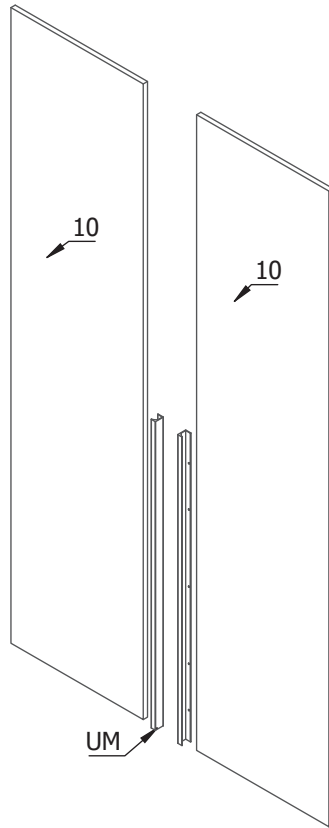

**GB>**Please only clean with a duster or a damp cloth. Do no use any abrasive cleaners.

Dear customer, should there be any plece missing or damaged, kindly mark this piece clearly on the attached assembly instructions and return them to us.

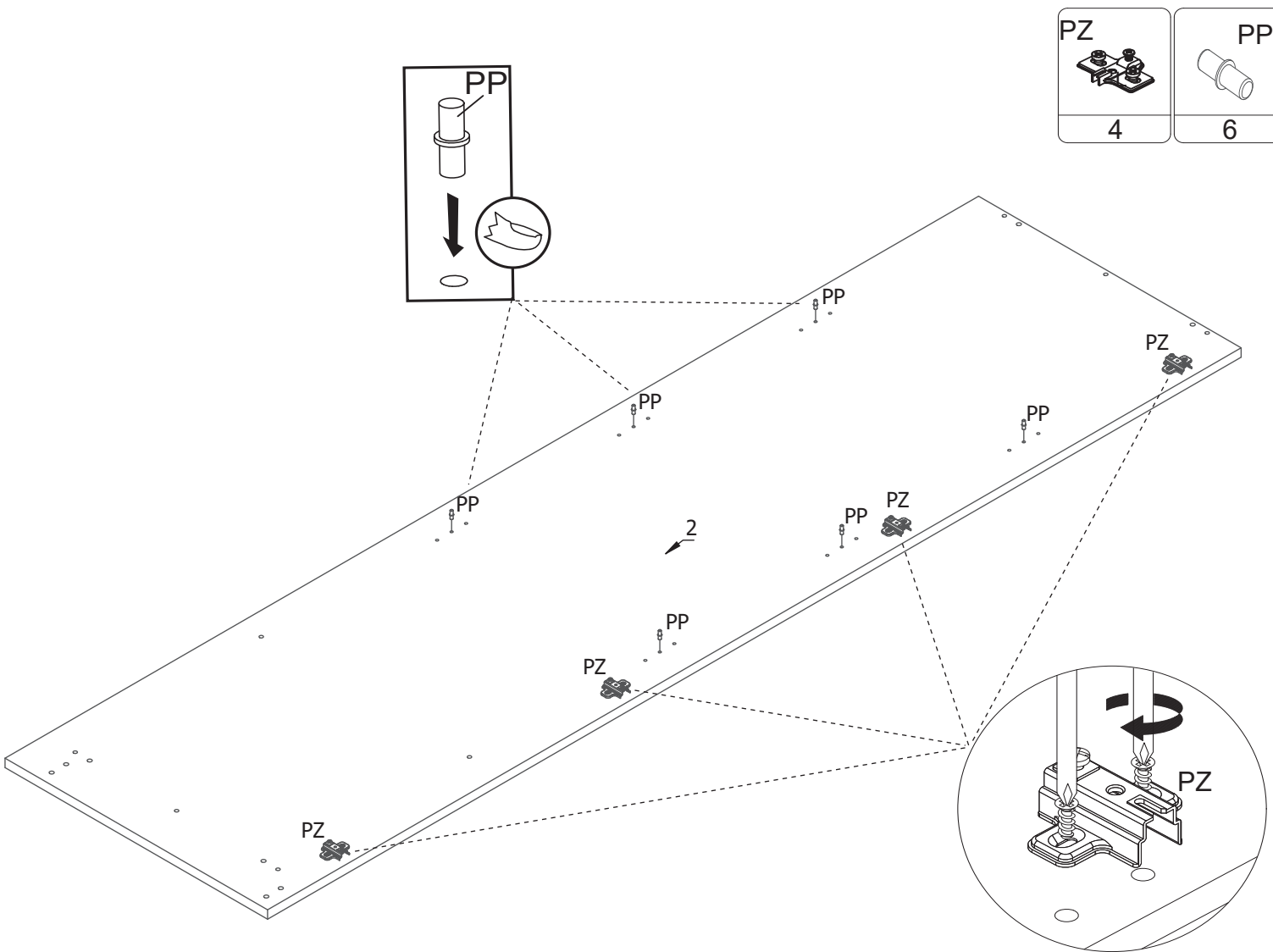
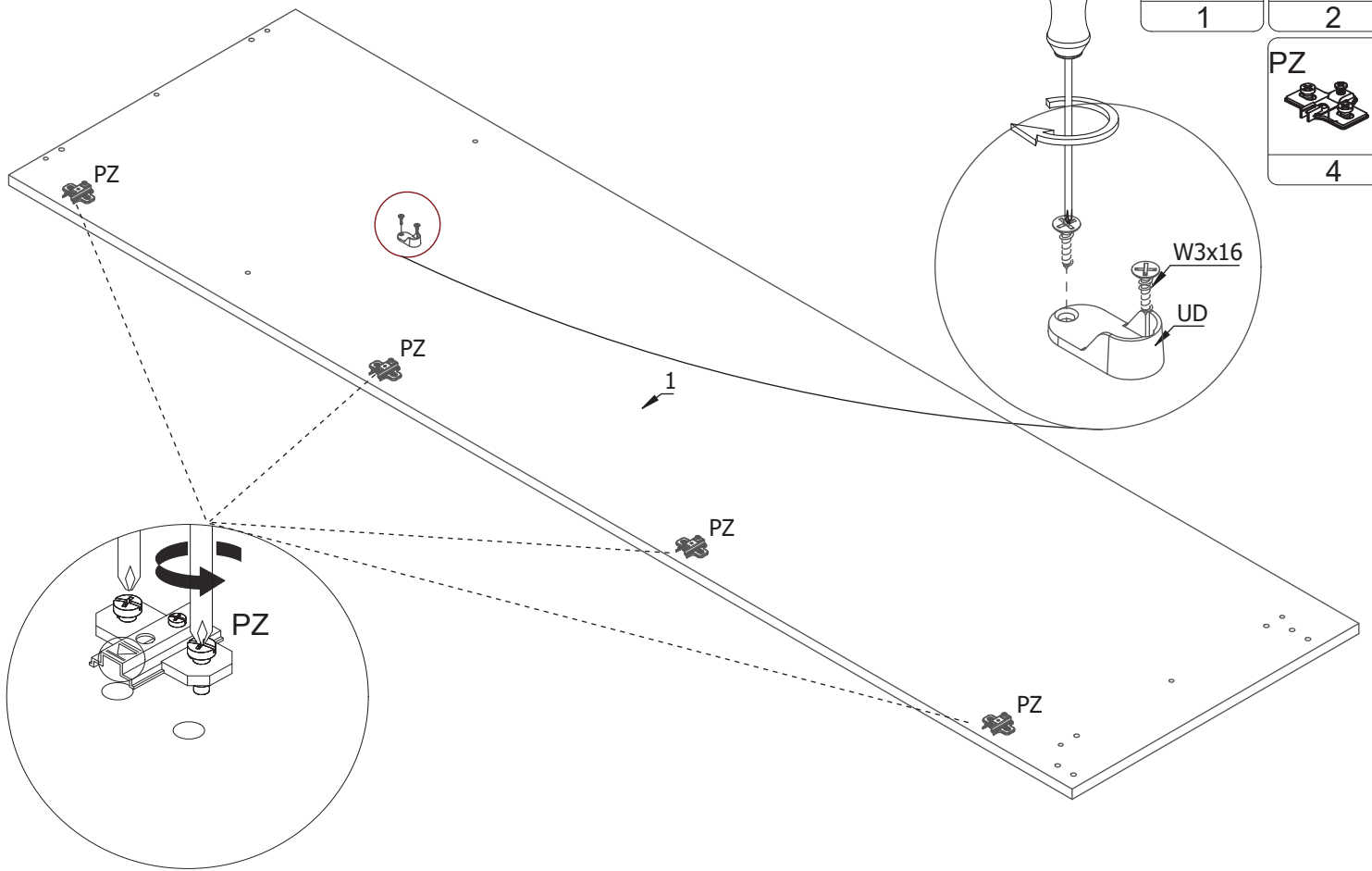
Szafa 100			
nr		nr	
1	2150 x 581	7	476 x 497
2	2150 x 581	8	968 x 100
3	968 x 581	9	2040 x 498
4	968 x 581	10	2043 x 495
5	2017 x 581		
6	476 x 497		





K30 	PP 	UD 	W3x16 
6	6	1	2

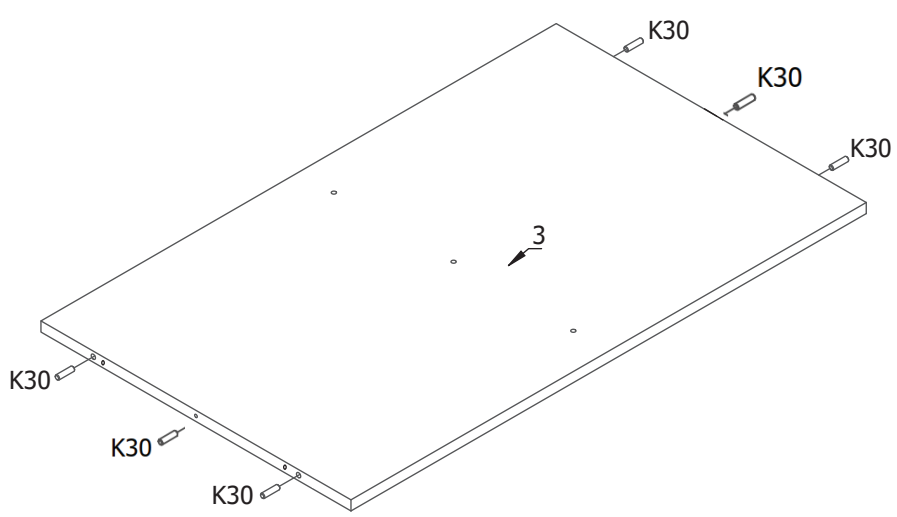
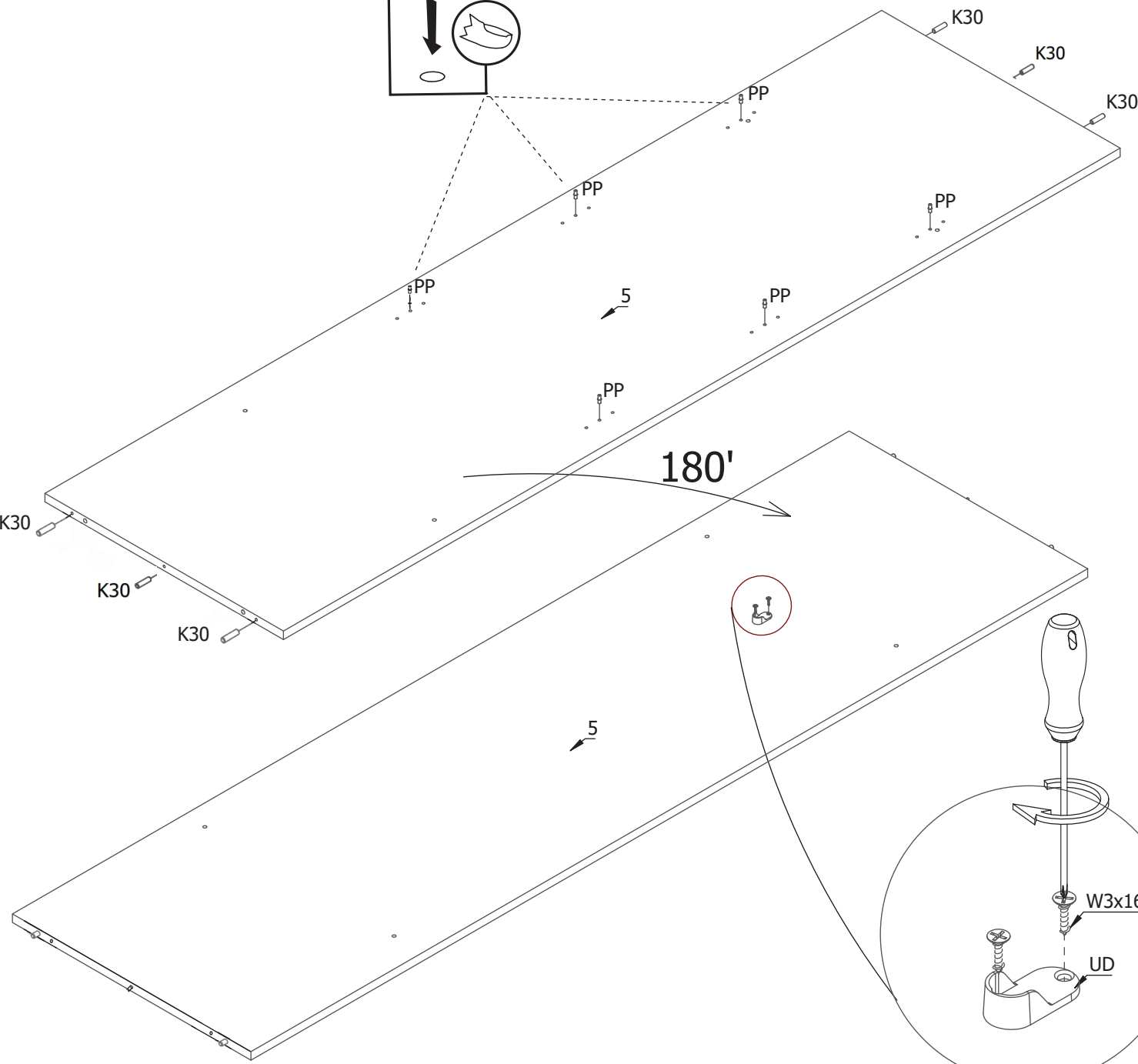
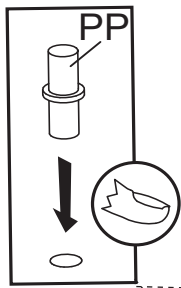

K30 
6

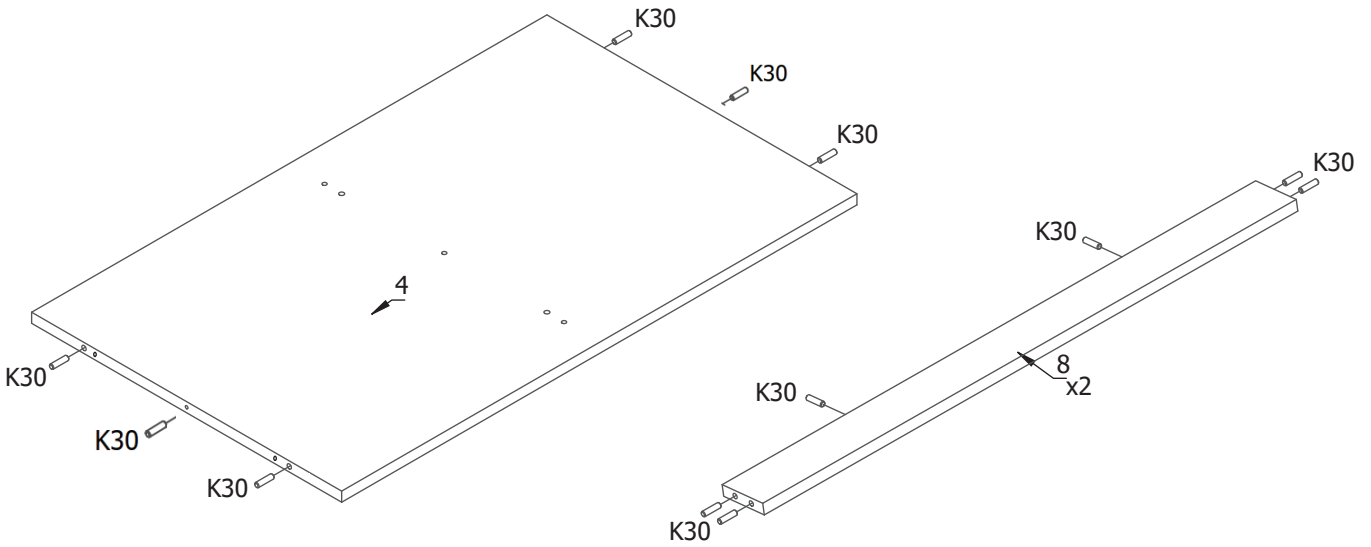

ZP

8

W3x16



16

W3,5x13

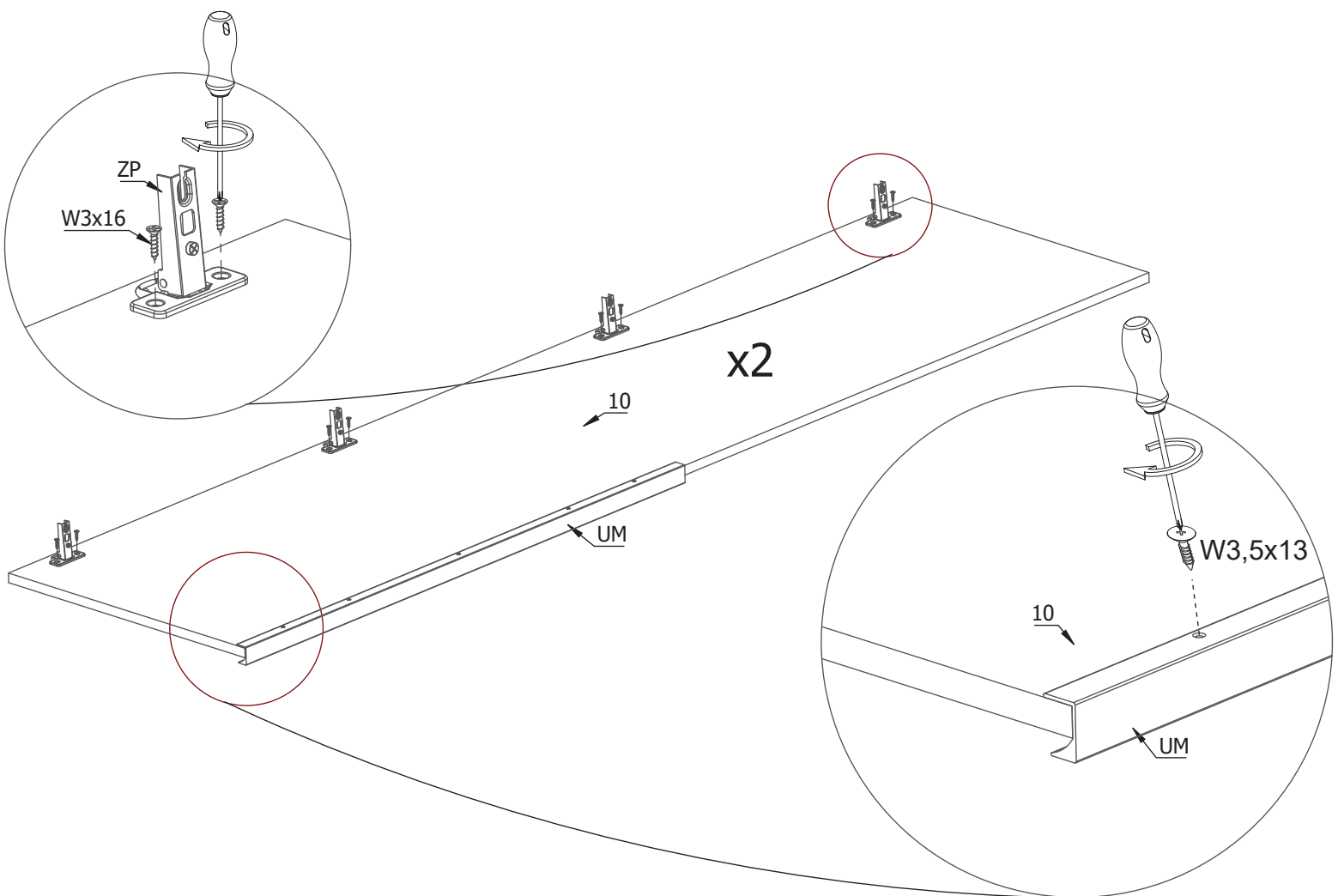

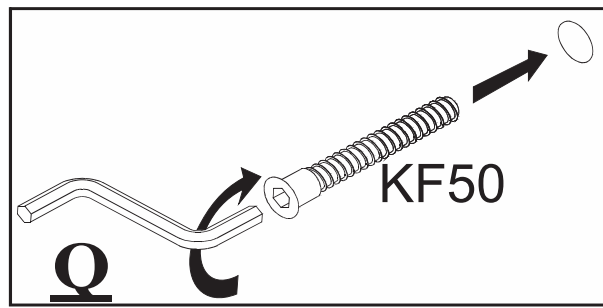
10



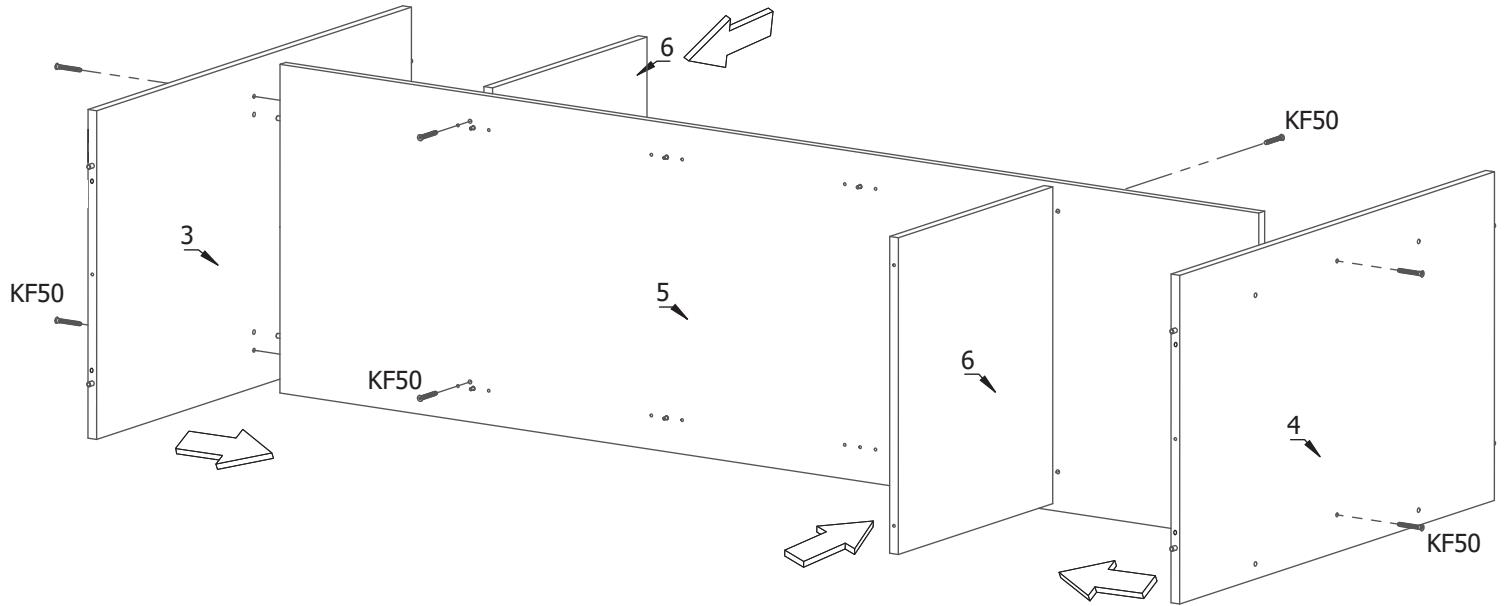

KF50	Q
	
8	1



KF50	Q
	
12	1

