

PL- Przed rozpoczęciem zapoznać się z instrukcją montażu/ DE- Vor die montage, bitte beiliegende anweisungen folgen/ EN- Before starting, refer to the assembling advice in annex/ CZ- Před zahájením naleznete v montážním návodu/ HR- Prije početka, uzmite upute za montažu u prilogu/ HU- A termék összeszerelését megelőzően kérjük olvassa el az összeszerelési útmutatóban leírtakat/ SK- Pred začiatkom si prečítajte pokyny na montáž/ FR- Avant de commencer, se reporter aux conseils de montage en annexe

VAMOS

Witryna

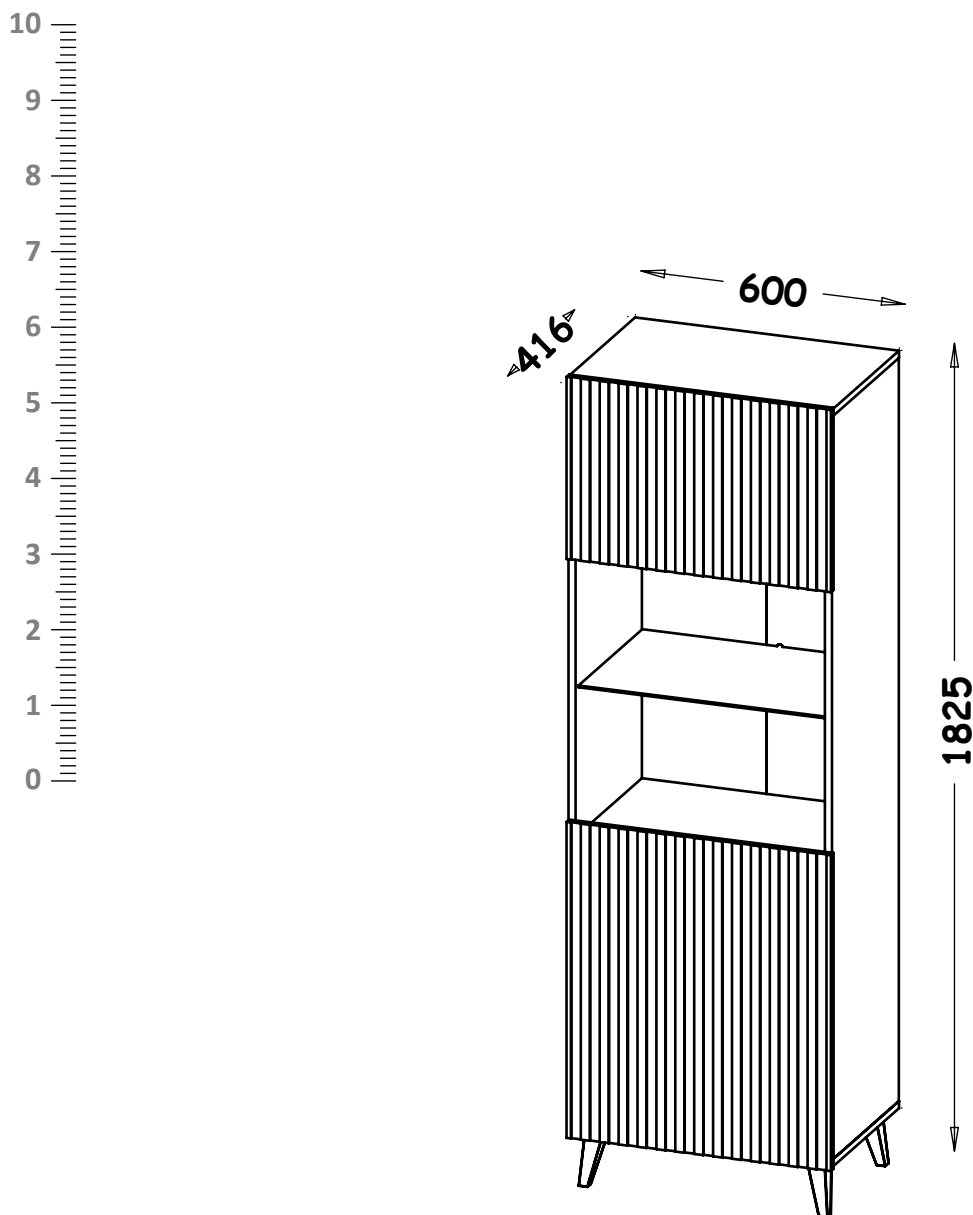

PL- Narzędzia niezbędne do montażu (nie dostarczone przez producenta)/ DE- Für die Montage notwendige Werkzeuge (nicht vom Hersteller mitgeliefert)/ EN- Tools required for assembly (not provided by the manufacturer)/ CZ- Nástroje nezbytné pro montáž (nejsou dodávány výrobcem)/ HR- Alat potreban za montažu (nije osiguran od strane proizvođača)/ HU- Az összeszereléshez szükséges (a gyártó által nem szállított) szerszámok/ SK- Nástroje potrebné na montáž (nedodávané výrobcem)/ FR- Outils requis pour l'assemblage (non fourni par le fabricant)

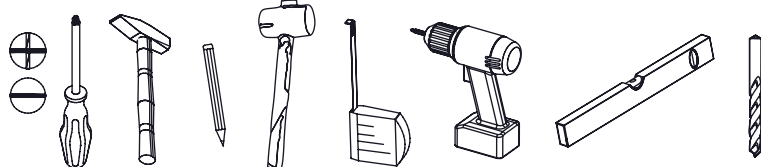

[1]

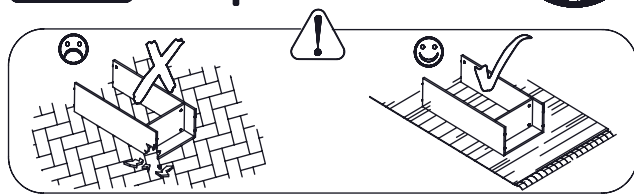

v 1.0

31.05.2022



PL - UWAGA!

W przypadku reklamacji prosimy o podanie numeru serii znajdującego się na kartonie. W związku z tym prosimy o zachowanie opakowań do momentu zmontowania mebla. W przypadku stwierdzenia uszkodzenia któregoś z elementów, prosimy nie montować modułu, którego częścią jest dany element.

DE - HINWEIS!

Im Falle einer Reklamation geben Sie bitte die Seriennummer, die sich auf der Verpackung befindet. Daher bitten wir Sie immer die Verpackung solange aufzubewahren, bis die Möbelstücke vollständig montiert sind. Sollten Schäden an Einzelteilen auftreten, bitte sehen Sie von der Montage des Moduls ab.

EN - ATTENTION!

In case of claim please give us series number which you can find on the box. Thereupon please keep the package until montage of furniture is done. In case verified damage any of elements, please do not mount module, which is a parts of particular element.

CZ - POZOR!

Při reklamaci prosíme o uvedení čísla šarže, které se nachází na obale. V souvislosti s tímto prosíme o uchování obalů do okamžiku složení nábytku. V případě poškození některého z dílů, prosíme neskládat model, jehož součástí poškozený díl je.

HR - PAŽNJA!

U slučaju reklamacije, molimo Vas da nam date serijski broj koji možete pronaći na ambalaži. Molimo Vas da zadržite ambalažu sve dok nije kompletna montaža proizvoda. Ukoliko je uočeno oštećenje bilo kojeg elementa, molim Vas da ne montirate oštećeni dio.

HU - FIGYELEM!

A bűtor összeszereléséig kérjük őrizze meg a csomagolást, mivel reklamáció esetén a kartonon található szériaszámot kell megadni. Amennyiben észreveszi, hogy valamelyik bútorelem sérült kérjük ne folytassa az összeszerelését a modulnak melynek része az adott elem.

SK - POZOR!

V prípade sťažnosti uveďte číslo šarže na balení. Balenie preto uschovajte, kým nezostavíte nábytok. V prípade poškodenia niektorého z komponentov, nemontujte modul, ktorého je provok súčasťou.

FR - ATTENTION!

En cas de réclamation s'il vous plaît nous donner le numéro de série que vous pouvez trouver sur la boîte.





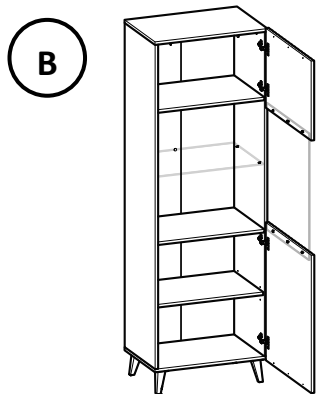
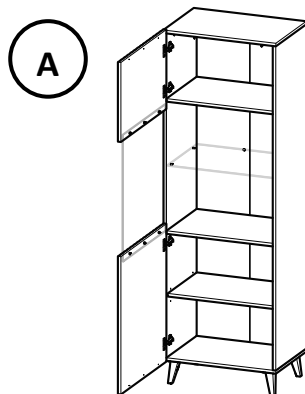



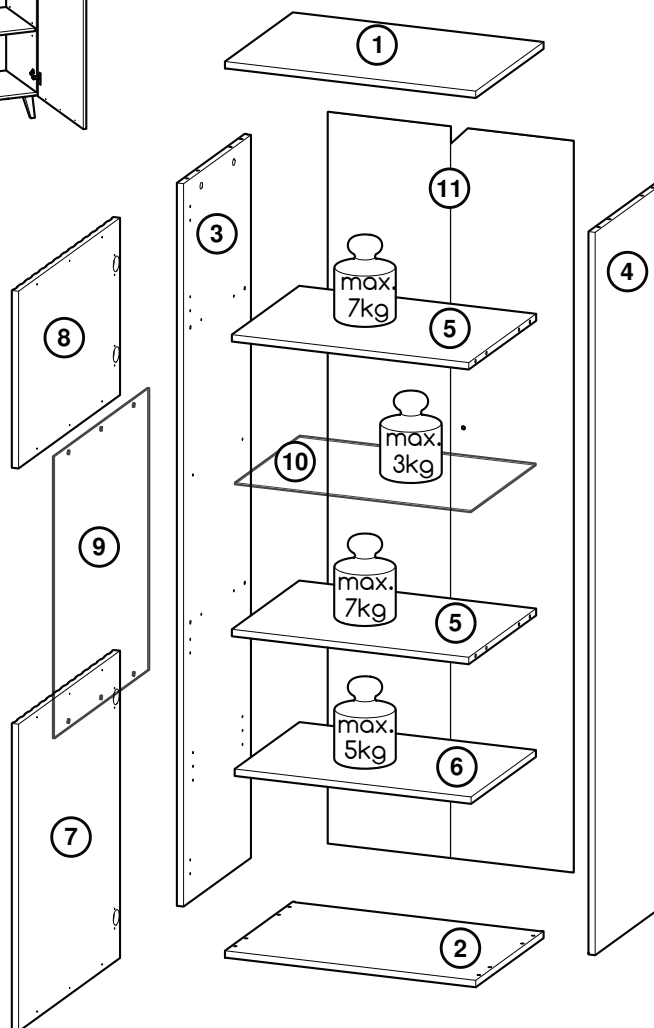









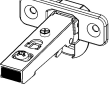

Veillez conserver le colis jusqu'à ce que le montage des meubles soit terminé.

En cas d'endommagement éléments, s'il vous plaît ne pas monter le module, qui est une partie de l'élément particulier.

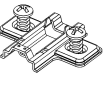

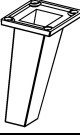
Nr	Xmm	Ymm	Zmm	x
1	597	400	16	1
2	597	400	16	1
3	1668	400	16	1
4	1668	400	16	1
5	564	397	16	2
6	563	382	16	1
7	598	709	16	1
8	598	409	16	1
9	558	650	4	1
10	562	382	4	1
11	585	1688	2,5	1



S26  2x Ø6/16	G37  1x Ø4x13	G17  1x 4x45	J24  1x L150	U6  1x Ø8x40	A1  4x Ø7x50
K1  12x Ø15x12	K5  12x 34mm	I20  12x Ø4/Ø17	B1  16x Ø8x35	F2  4x Ø5	I18  1x Ø14
C3  4x SOFT	G5  8x 4x13	D3  4x SOFT	W4  64x	W2  1x 4mm	P46  4x h120
G11  16x 4x20	F11  4x Ø5	I3  6x	G50  6x 3,5x16		

I

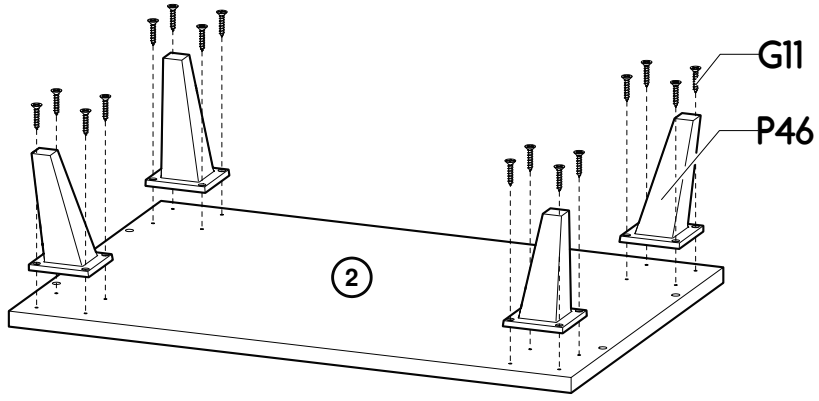

II

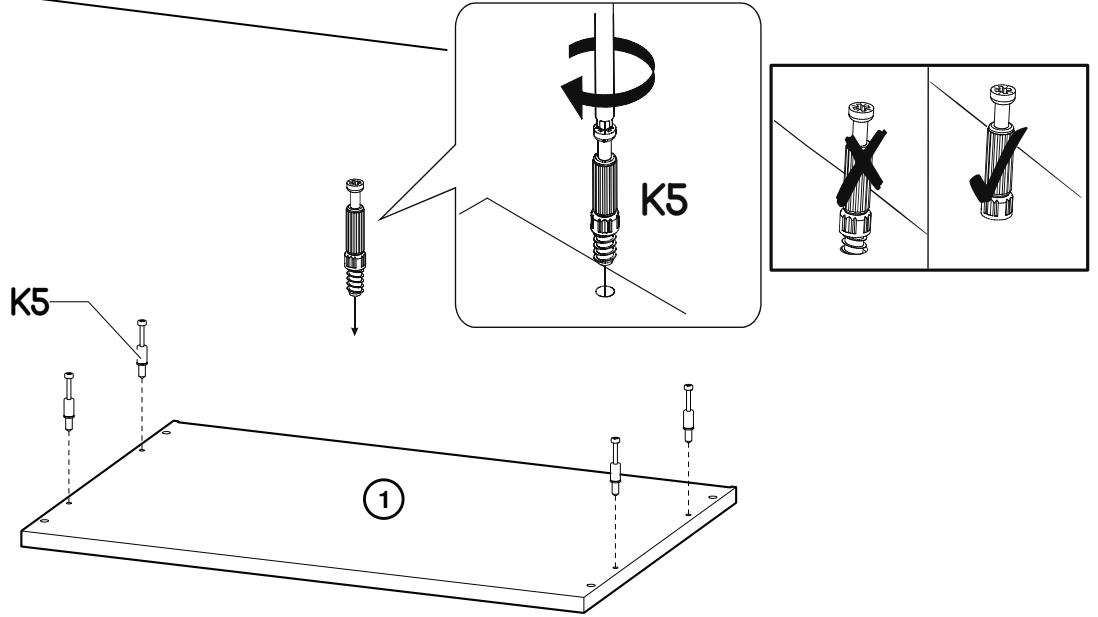

III

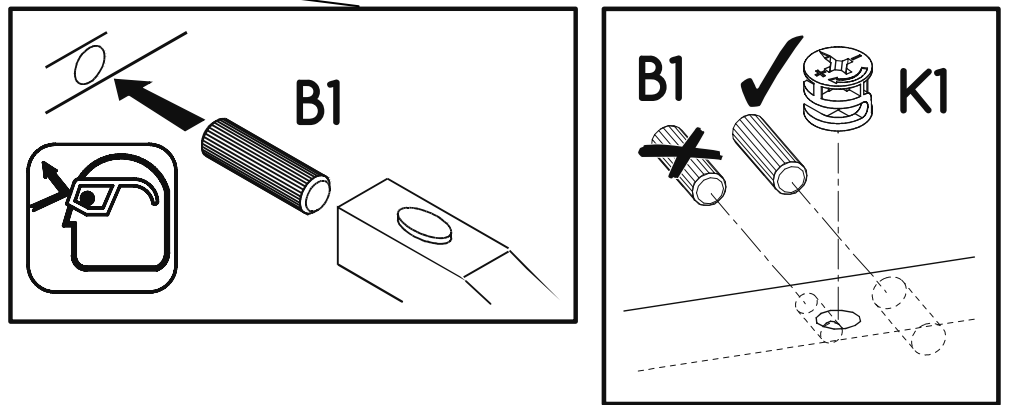

x2

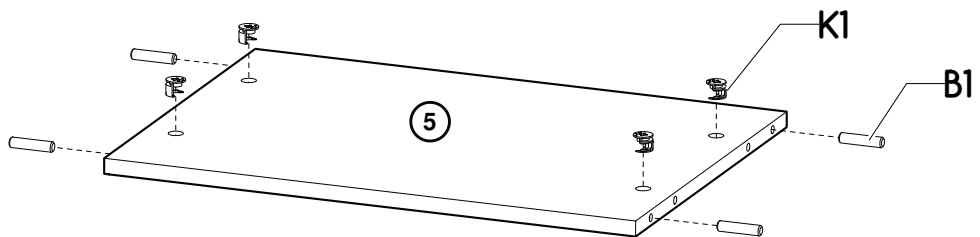

IV

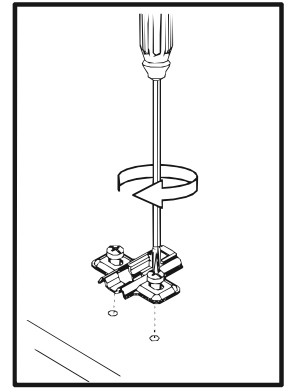
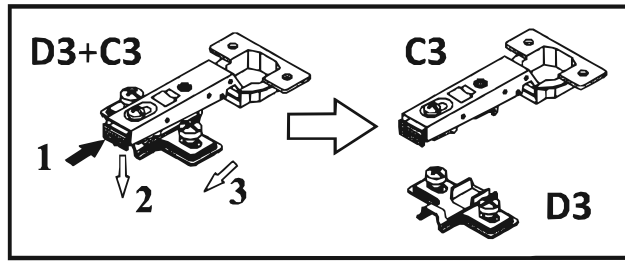

A

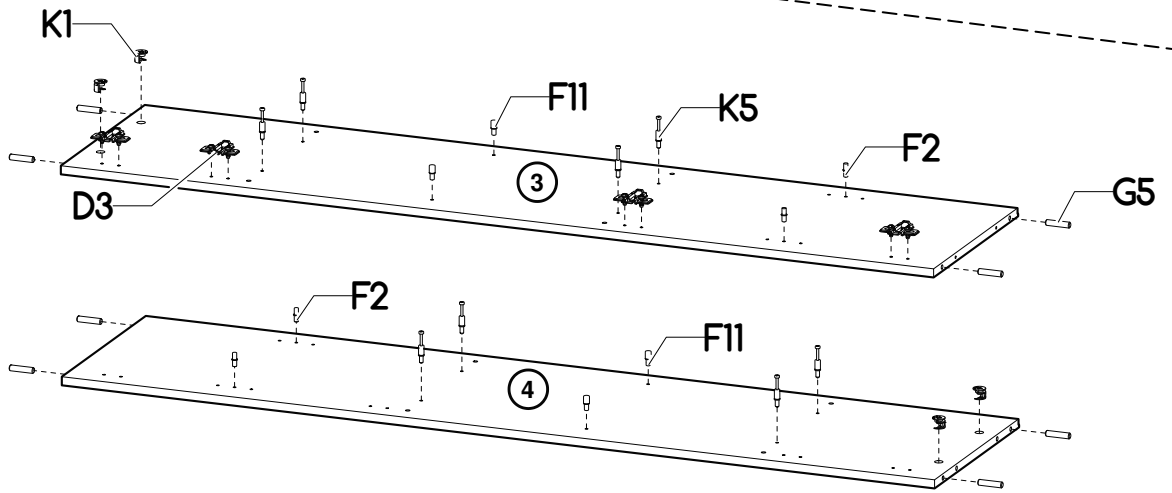
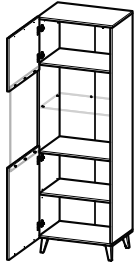

B

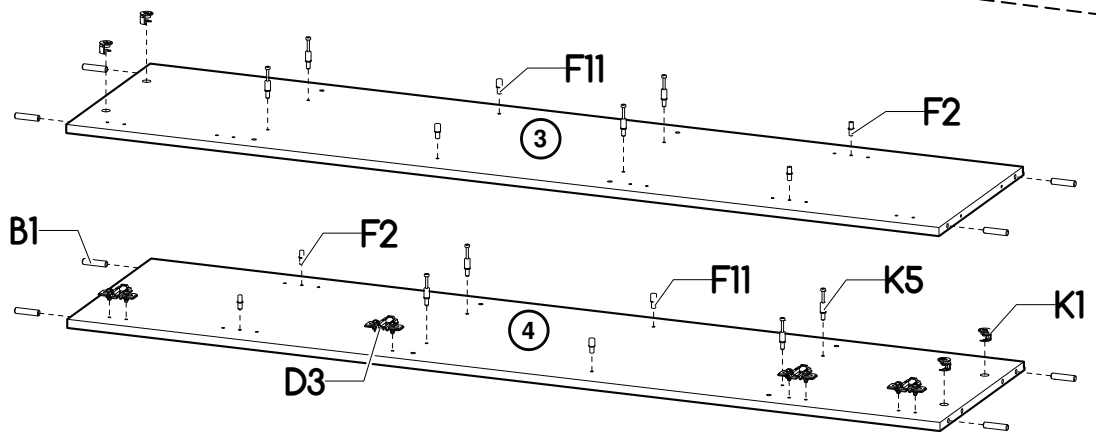
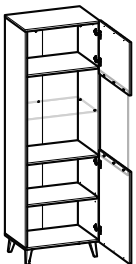

V

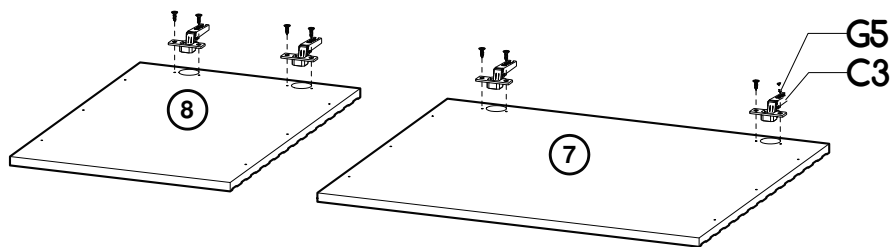

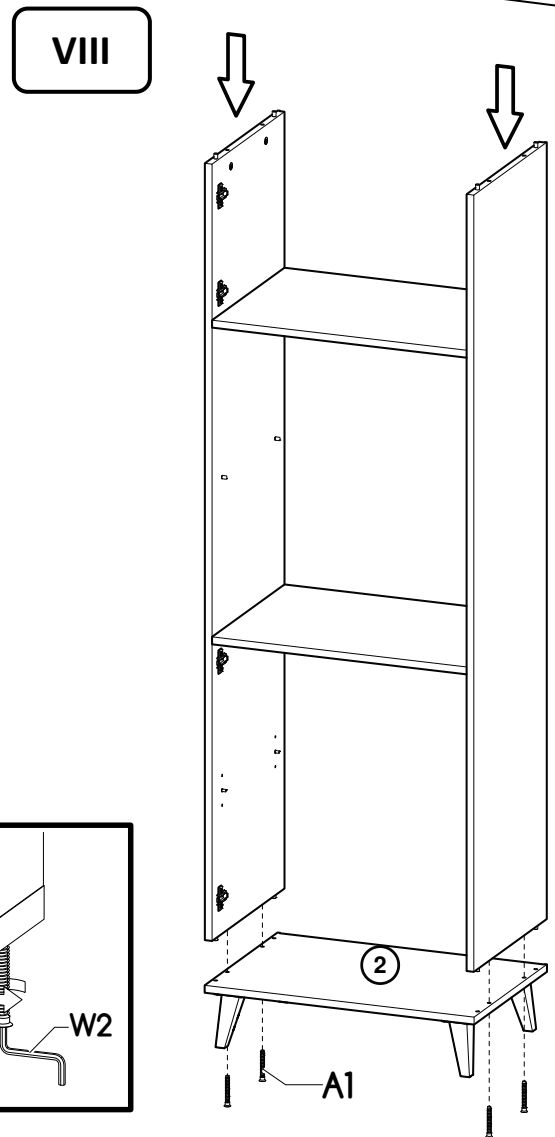
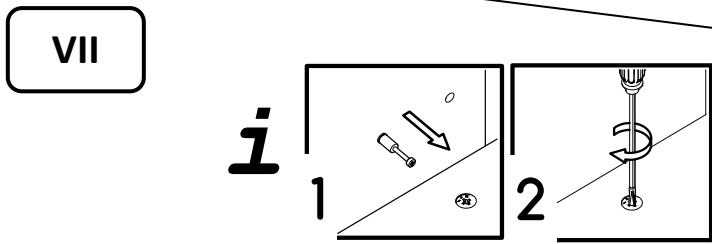
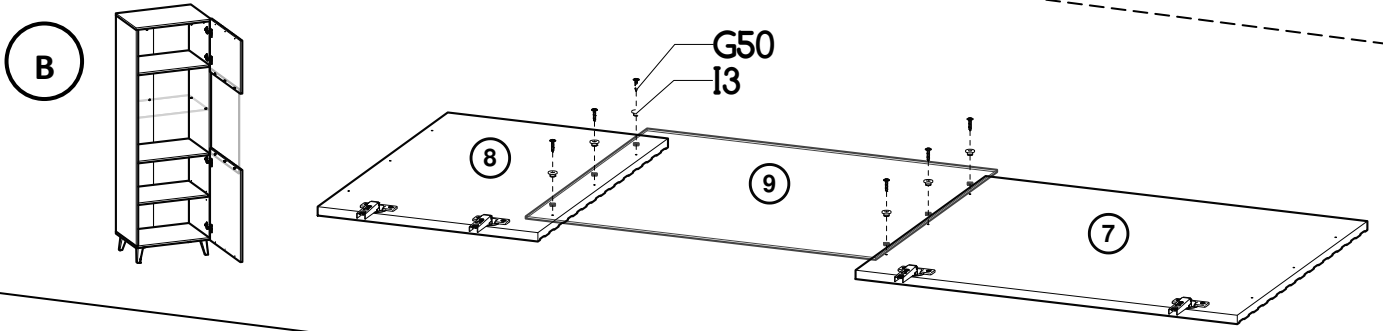
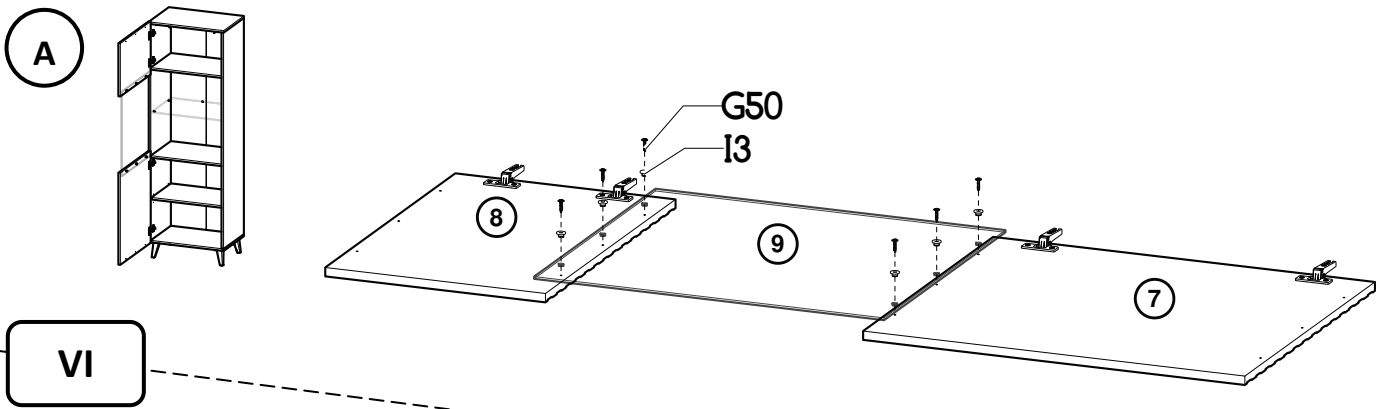

IX

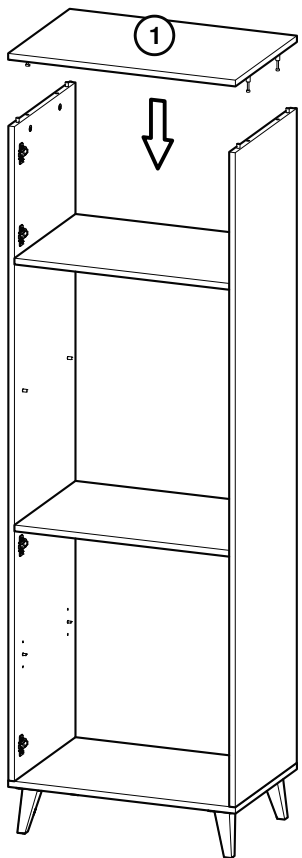

X

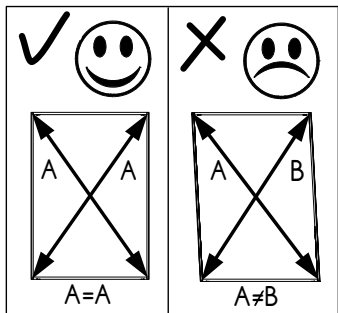
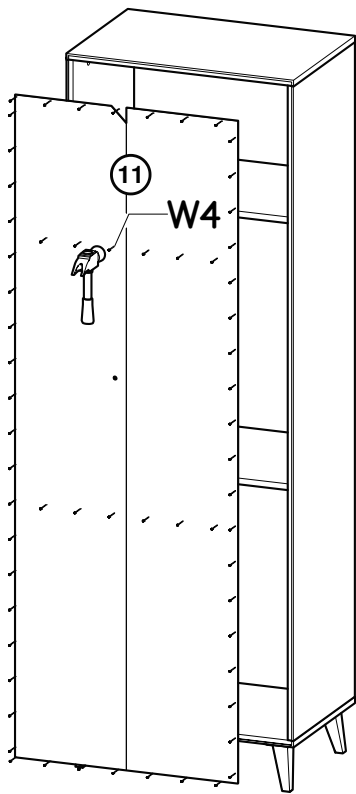

XI

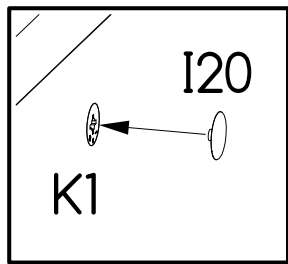
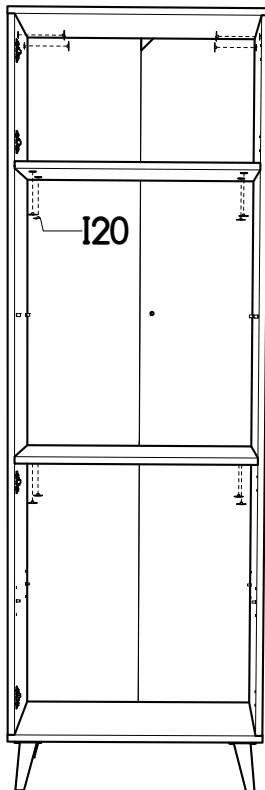

XII

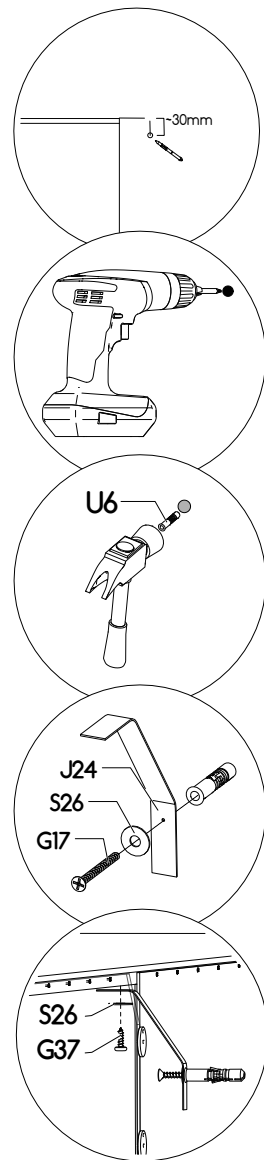
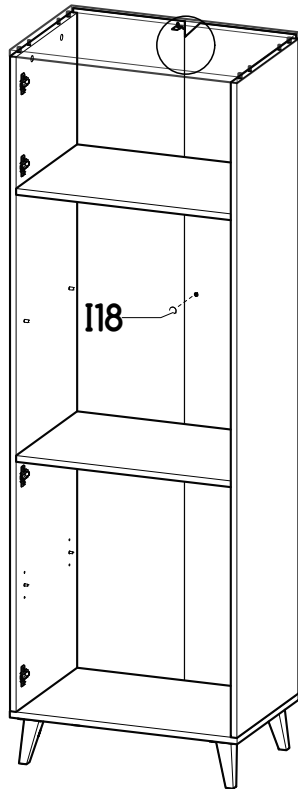

XIII

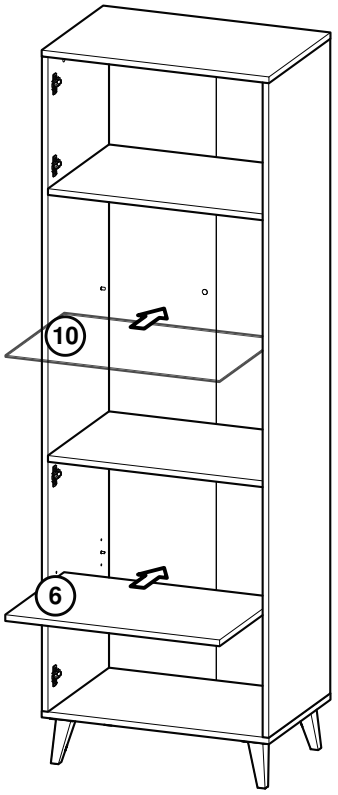

XIV

A

B

