

Arcan M

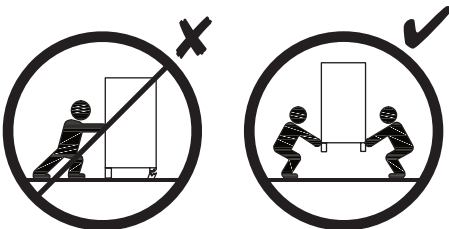

- PL Instrukcja montażu
- DE Montageanleitung
- NL Handleiding voor de montage
- TR Montaj talimatı
- FR Notice de montage
- CZ Montážní návod
- HU Szerelési útmutató
- GB Assembly instructions
- RU Инструкция по монтажу
- IT Istruzioni di montaggio
- SK Návod na montáž
- RO Instrucțiuni de montaj
- ES Instrucciones de montaje
- PT Instruções de montagem

Producent - Produzent - Üretici - Producteur - Výrobce -
 Termelő - Producer - Produttore - Producător - Productor
MEBLE LASKI KACZOROWSKA
 Laski, ul. Kępińska 21, 63-620 Trzcinica
 meble-laski@meble-laski.com.pl

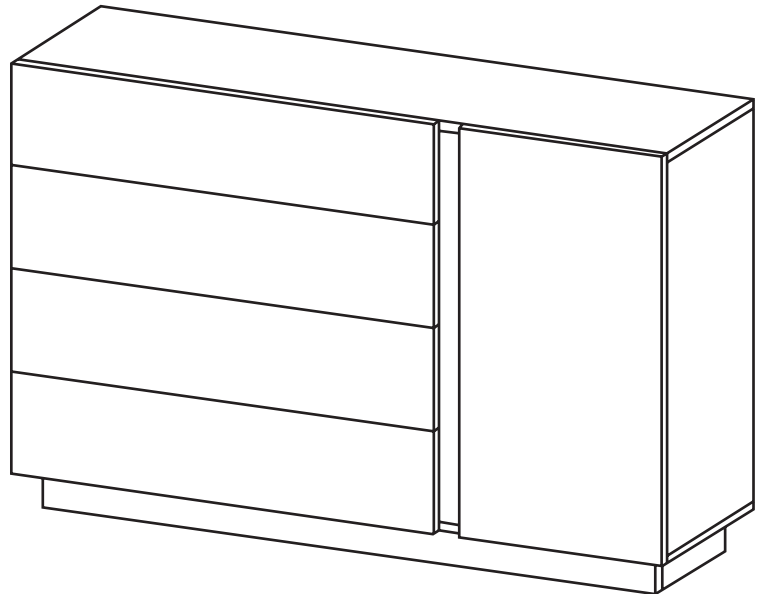

2025-01-03

3,5h

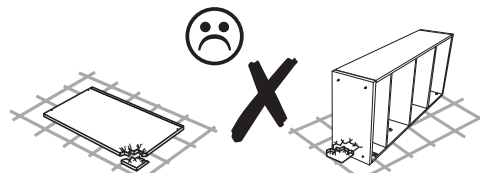
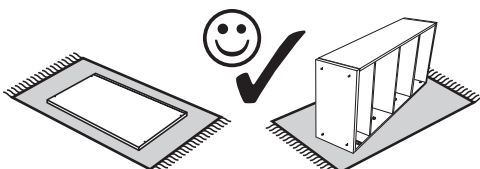
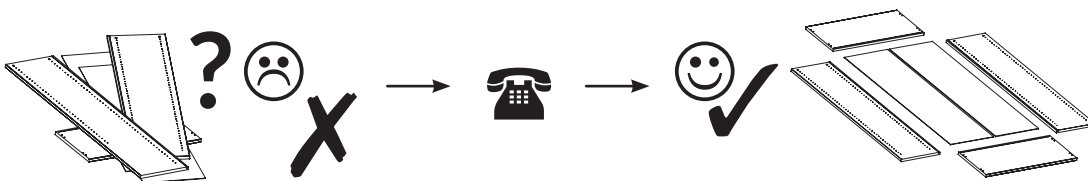
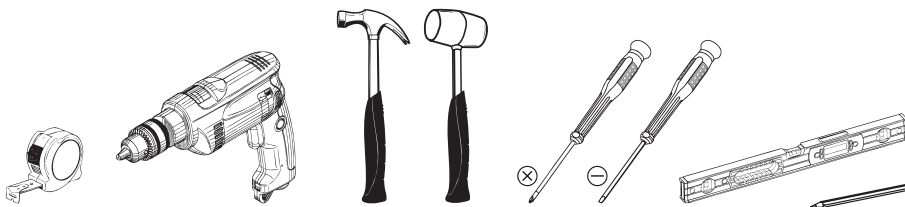

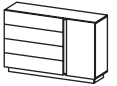

PL Przed rozpoczęciem montażu mebla wszystkie elementy należy sprawdzić czy nie są uszkodzone. W przypadku wykrycia uszkodzenia elementu należy odstąpić od montażu mebla i złożyć reklamację.

Nie wolno przekraczać podanych maksymalnych wartości obciążenia. W innym przypadku można mebel uszkodzić lub zniszczyć.

Przed zawieszeniem mebla, lub przymocowaniem go do ściany (w celu zabezpieczenia przed przewróceniem), sprawdź wcześniej rodzaj i wytrzymałość ściany. Dobierz odpowiednie kołki i wkręty do rodzaju ściany. W przypadku wątpliwości skontaktuj się ze specjalistą. Montaż musi zostać wykonany przez osobę kompetentną.

Meble zawierające płyty drewnopochodne mogą emitować substancje zanieczyszczające do powietrza w pomieszczeniu. Dlatego zaleca się, po zamontowaniu mebli, częste wentrowanie pomieszczenia przez co najmniej cztery tygodnie.

DE Vor Beginn der Möbelmontage sollten alle Elemente auf Beschädigungen überprüft werden. Wenn ein Element des Produkts beschädigt ist, installieren Sie das Produkt bitte nicht und reichen Sie eine Beschwerde ein.

Überschritten Sie die angegebenen Maximalbelastungen nicht. Andernfalls kann das Möbelstück beschädigt oder zerstört werden.

Bevor Sie ein Möbelstück an einer Wand aufhängen oder befestigen (um es gegen Umkippen zu sichern), prüfen Sie Art und Tragfähigkeit der Wand. Wählen Sie die für die Wand geeigneten Dübel und Schrauben. Im Zweifelsfall kontaktieren Sie bitte einen Fachmann. Die Montage muss durch eine sachkundige Person ausgeführt werden.

Möbel mit Holzwerkstoffplatten können Schadstoffe in die Raumluft abgeben, daher Es wird empfohlen, den Raum nach dem Einbau der Möbel mindestens vier Wochen lang häufig zu lüften.

FR Avant de commencer l'assemblage du meuble, tous les éléments doivent être vérifiés pour déceler tout dommage. Si un élément du produit est endommagé, veuillez ne pas installer le produit et déposer une plainte.

Ne dépassez pas les charges maximum indiquées. Sinon, le meuble peut être endommagé ou détruit.

Avant de suspendre le meuble ou de le fixer au mur (dans le but d'éviter un renversement), vérifiez au préalable le type et la résistance du mur. Utilisez les chevilles et les vis adaptées au type de mur. En cas de doute, veuillez contacter un spécialiste. Le montage doit être réalisé par une personne compétente.

Les meubles contenant des panneaux à base de bois peuvent émettre des substances polluantes dans l'air intérieur. Donc il est recommandé, après l'installation des meubles, d'aérer fréquemment la pièce pendant au moins quatre semaines.

CZ Před zahájením montáže nábytku je třeba zkontrolovat poškození všech prvků. Pokud je některý prvek produktu poškozen, zdržte se instalace produktu a podejte stížnost.

Nepřekračujte uvedené maximální zatížení. V opačném případě může dojít k poškození nebo zničení nábytku.

Před zavěšením nábytku nebo jeho připevněním ke zdi (za účelem zajištění před převrácením) dříve zkontrolujte druh a odolnost stěny. Vyberte k druhu stěny vhodné hmoždinky a šrouby. V případě pochybností kontaktujte specialistu. Montáž musí být provedena kompetentní osobou.

Nábytek obsahující panely nabáží dřevnůževyvolňovat znečišťující látky dovnitřnímu ovzduší. Protodoporučuje se po instalaci nábytku místnost pravidelně větrat po dobu nejméně čtyř týdnů.

HU A bútör szerelés megkezdése előtt ellenőrizni kell az összes elem sérülését. Ha a termék bármely eleme megsérült, kérjük, tartózkodjon a termék telepítésétől és nyújtson bepanaszt.

A megadott maximális terhelési értékeket nem szabad túllépni. Ellenkező esetben a bútör megsérülhet vagy megsemmisülhet.

A bútör felfüggesztése illetve falhoz való rögzítése (megakadályozva az esést) előtt ellenőrizze a fal fajtaját és szilárdságát. Megfelelő, a falhoz illő tipliket és csavarokat használjon. Ha kétsége támadna, konzultáljon szakemberrel. A felszerelést csak egy hozzáértő szakembervéghezeti el.

A fa alapú paneleket tartalmazó bútörök szennyező anyagokat bocsáthatnak ki a beltéri levegőbe. Ezért ajánlott a bútörök beszerelése után legalább négy hélig rendszeresen szellőztetni a helyiséget.

GB Before starting the furniture assembly, all elements should be checked for damage. If any element of the product is damaged, please refrain from installing the product and file a complaint.

The specified maximum load values must not be exceeded. Otherwise, the piece of furniture may be damaged or destroyed.

Before suspending or fixing furniture to the wall (in order to prevent falling over), check the type and strength of the wall. Select wall plugs and screws appropriate for the given type of the wall. In the case of doubts, contact a specialist. The installation must be performed by a competent person.

Furniture containing wood-based panels can emit polluting substances into the indoor air. Therefore recommended, after installing the furniture, to ventilate the room frequently for at least four weeks.

SK Pred začatím montáže nábytku by sa mali zkontrolovať všetky prvky, či nie sú poškodené. Ak je ktorýkoľvek prvok výrobku poškodený, neinstalujte výrobok a reklamujte ho.

Uvedené hodnoty maximálneho zaťaženia nesmú byť prekročené. V opačnom prípade môže dôjsť k poškodeniu alebo zničeniu nábytku.

Pred zaviesení nábytku alebo jeho pripavením na stenu (za účelom zaistenia pred prevrátením) predtým zkontrolujte druh a odolnosť steny. Vyberte k druhu steny vhodné hmoždinky a skrutky. V prípade pochybností kontaktujte špecialistu. Montáž musí byť vykonaná kompetentnou osobou.

Nábytek obsahujúci dosky nabáží drevnůževyvolňovať znečišťujúce látky do vnútorného ovzdušia. Preto odporúča sa po inštalácii nábytku miestnosť pravidelne vetrať aspoň štyri týždne.

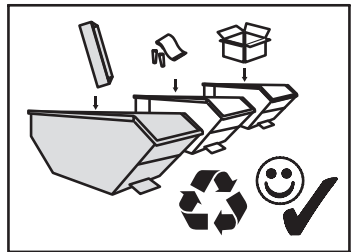
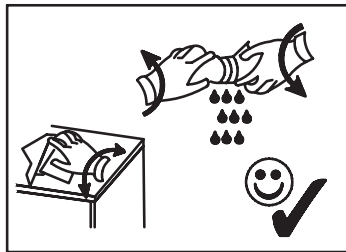
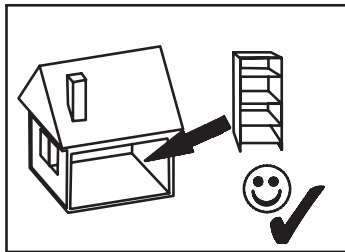
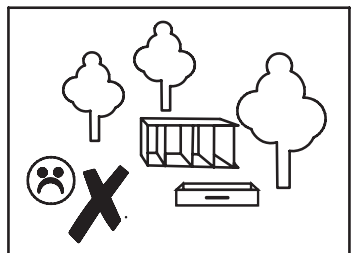
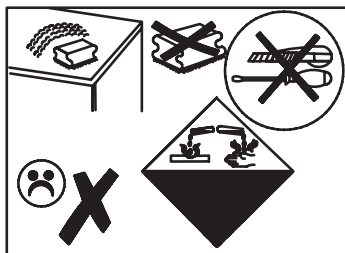
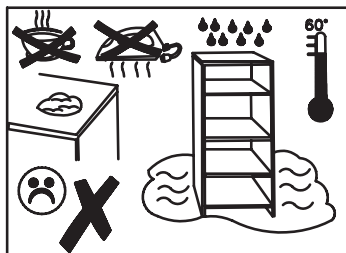
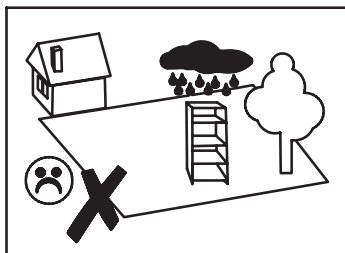

IT Prima di iniziare l'assemblaggio del mobile, tutti gli elementi dovrebbero essere controllati per danni. Se qualche elemento del prodotto è danneggiato, astenersi dall'installare il prodotto e presentare un reclamo.

I valori di carico massimo specificati non devono essere superati. In caso contrario, il mobile potrebbe essere danneggiato o distrutto.

Prima di appendere mobili, oppure attaccarli al muro (per proteggerli dal ribaltamento), verificare il tipo di parete e la resistenza del muro. Scegli i tasselli e viti più adatti per il tipo di muro. In caso di dubbi contattare uno specialista. Il montaggio deve essere fatto da una persona competente.

I mobili contenenti pannelli a base di legno possono emettere sostanze inquinanti nell'aria interna. Perciò si consiglia, dopo aver installato i mobili, di aereare frequentemente il locale per almeno quattro settimane.

NL Voordat u met de meubelmontage begint, moeten alle elementen op schade worden gecontroleerd. Als een onderdeel van het product beschadigd is, installeer het dan niet en dien een klacht in.

Overschrijd de aangegeven maximale belastingen niet. Anders kan het meubelstuk worden beschadigd of vernield.

Voordat u het meubel ophangt of bevestigt tegen de muur (om het te beschermen tegen omvallen) dient u het type en de duurzaamheid van deze muur na te kijken. Maak gebruik van pluggen en schroeven die geschikt zijn voor het type muur. Neem in geval van twijfel contact op met een specialist. De assemblagedient te worden uitgevoerd door iemand met kennis van zaken.

Meubels met panelen op houtbasis kunnen vervuilstoffen in de binnenlucht uitstoten. Daarom Het is raadzaam om na het plaatsen van het meubilair de ruimte minimaal vier weken regelmatig te ventileren.

TR Mobilya montajına başlamadan önce tüm elemanlarda hasar olup olmadığını kontrol edilmelidir. Ürünün herhangi bir parçası hasar görmüşse, lütfen ürünü kumayın ve şikayette bulunun.

Belirtilen azami yük degerini aşmayın, aksi takdirde mobilya parçaları zarar görebilir veya kullanılamaz hale gelebilir.

Mobilyayı duvara asmadan veya montaj etmeden önce (devrilmesini önlemek için) duvarın türünü ve dayanıklılığını kontrol edin. Duvar auygun dübelleri ve vidaları seçin. Emin olamamanız durumunda bir uzmanla iletişime geçin. Kurulum yetkili bir kişi tarafından yapılmalıdır.

Aşağıdaki paneller içeren mobilyalar için mekan havasını kirletici maddeler yayabilir. Öyleyse Mobilyaların kurulumundan sonra odanın az dört hafta boyunca sık sık havalandırılması önerilir.

RO Înainte de a începe asamblarea mobilierului, toate elementele trebuie verificate pentru a nu se deteriorează. Dacă vreun element al produsului este deteriorat, vă rugăm să vă abțineți de la instalarea produsului și să depuneți o reclamație.

Valorile maxime de sarcină specificate nu trebuie depășite. În caz contrar, piesa de mobilier poate fi deteriorată sau distrusă.

Înainte de suspendarea unei piese de mobilier sau atașarea acestuia la perete (pentru a preveni bascularea), verificați în prealabil tipul și gradul de rezistență a peretelui. Montați diblurile și șuruburile adecvate pentru tipul de perete. În caz de îndoieli, consultați un specialist. Instalarea trebuie să fie efectuată de către o persoană competentă.

Mobilierul care conține panouri de lemn poate emite substanțe poluante în aerul interior. Prin urmare se recomandă, după montarea mobilierului, aerisirea frecventă a încăperii timp de cel puțin patru săptămâni.

ES Antes de comenzar el montaje de los muebles, todos los elementos deben comprobarse en busca de daños. Si algún elemento del producto está dañado, absténgase de instalar el producto y presente una queja.

No se deben exceder los valores de carga máxima especificados. De lo contrario, el mueble puede dañarse o destruirse.

Antes de colgar o fijar el mueble en el muro (a fin de proteger contra el vuelco del mueble), compruebe de antemano la naturaleza y la resistencia de la pared. Seleccione tacos y tornillos adecuados para el tipo de la pared. En caso de duda, consulte a un especialista, debiendo efectuar este montaje una persona competente.

Los muebles que contienen paneles de madera pueden emitir sustancias contaminantes al aire interior. Por lo tanto se recomienda, después de instalar los muebles, ventilar la habitación con frecuencia durante al menos cuatro semanas.

PT Antes de iniciar a montagem do móvel, todos os elementos devem ser verificados quanto a danos. Se algum elemento do produto estiver danificado, evite instalar o produto e apresente uma reclamação.

Os valores de carga máxima especificados não devem ser excedidos. Caso contrário, o móvel pode ficar danificado ou destruído.

Antes de suspender ou fixar móveis à parede (para evitar quedas), verifique o tipo e a resistência da parede. Selecione buchas e parafusos adequados ao tipo de parede. Em caso de dúvida, contacte um especialista. A instalação deve ser realizada por uma pessoa competente.

Os móveis que contenham painéis de madeira podem emitir substâncias poluentes para o ar interior. Assim, recomenda-se, após a instalação dos móveis, ventilar o ambiente frequentemente durante pelo menos quatro semanas.

RU Прежде чем приступить к сборке мебели, следует проверить все элементы на предмет повреждений. Если какой-либо элемент продукта поврежден, воздержитесь от установки продукта и подайте жалобу.

Указанные максимальные значения нагрузки превышать нельзя. В противном случае предмет мебели может быть поврежден или разрушен.

Прежде чем подвешивать или крепить мебель к стене (во избежание падения), проверьте тип и прочность стены. Выбирайте дюбели и шурупы, подходящие для данного типа стены. В случае сомнений обратитесь к специалисту. Установка должна выполняться компетентным лицом.

Мебель, состоящая из древесных плит, может выделять загрязняющие вещества в воздух в помещении. Поэтому рекомендуется после установки мебели часто проветривать помещение в течение как минимум четырех недель.

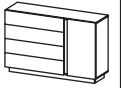

A 7 x 50 mm x 8	B 8 x 32 mm x 42	C (CD) x 2	DT x 2	E 3,5 x 13 mm x 15	E2 3 x 20 mm x 41
G2 x 6	H1 x 10	K L=350 mm x 4	O2 x 5	P x 4	R H=11 mm x 16
RB x 16	T3 5 x 9 mm x 16	U L=24,3 mm x 16	W1 x 1	XA x 1	XG x 2
ZA Ø 4 x 2	ZR Ø 15 x 16				

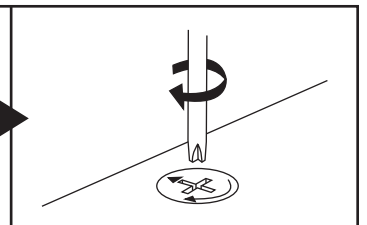
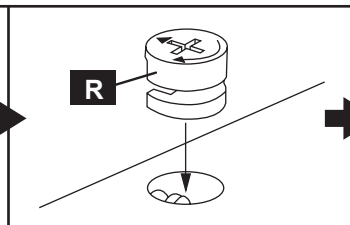
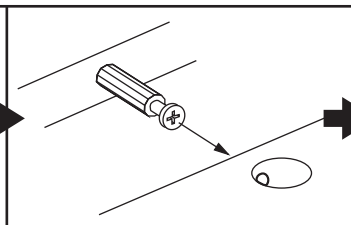
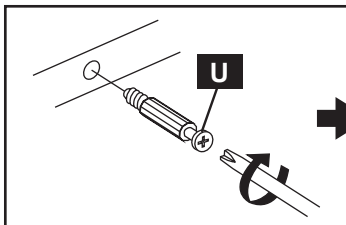
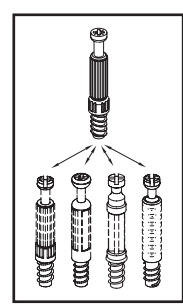
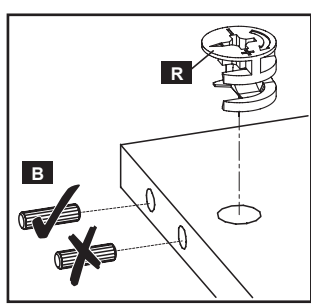
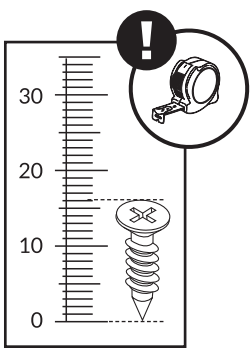
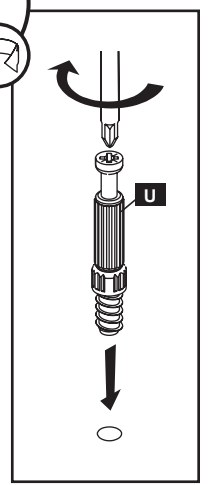
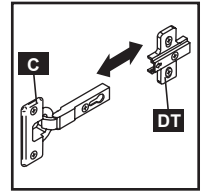
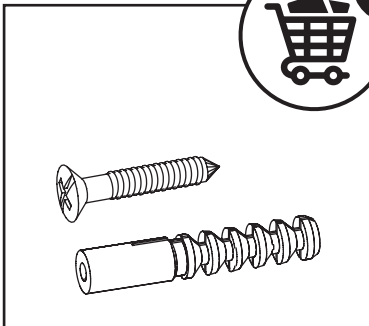

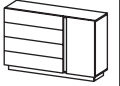

nr	↔ [mm]	↑ [mm]	↗ [mm]	Menge	Colli
M-1	1302	80	16	x1	1/2
M-2	288	80	16	x2	1/2
M-3	1381	384	16	x1	1/2
M-4	482	343	16	x1	1/2
M-5	850	100	16	x1	1/2
M-6	1381	384	16	x1	1/2
M-7	790	384	16	x1	2/2
M-8	790	369	16	x1	2/2
M-9	790	384	16	x1	2/2
M-10	100	790	16	x1	1/2
M-11	426	822	16	x1	2/2
M-12	1363	805	3	x1	1/2
M-13	894	202	16	x4	1/2
M-14	794	120	16	x4	1/2
M-15	350	120	16	x4	1/2
M-16	350	120	16	x4	1/2
M-17	823	356	16	x4	2/2

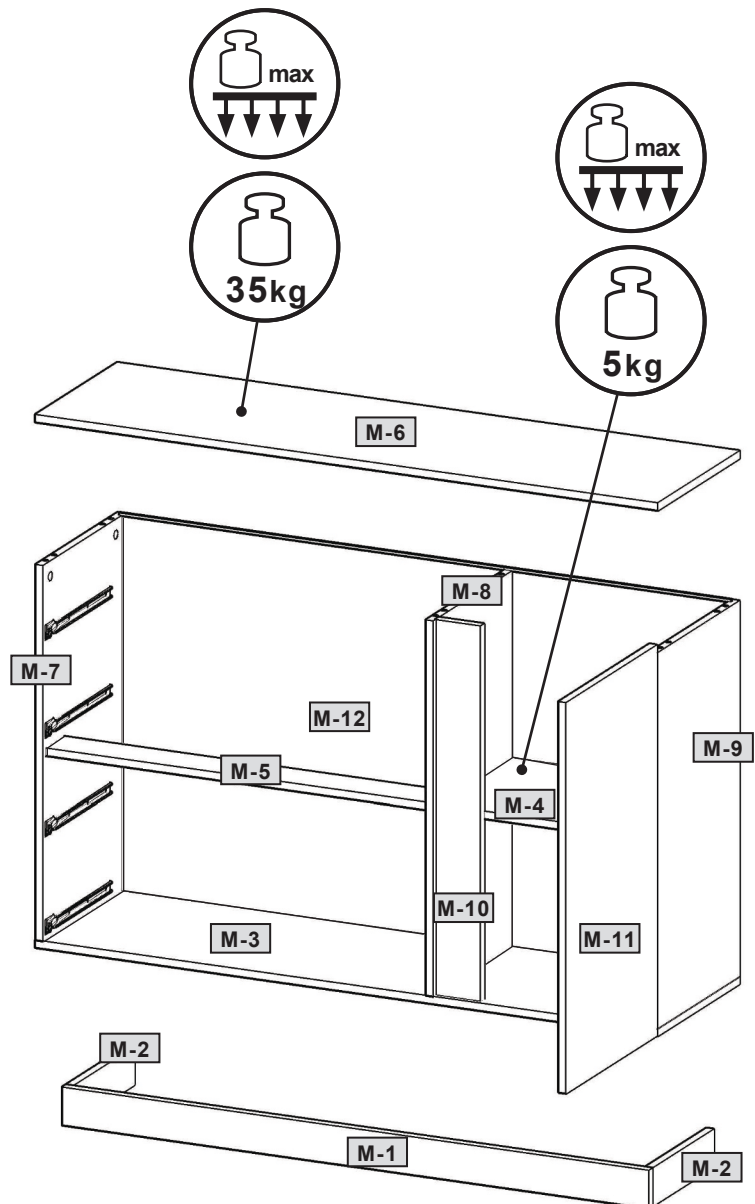
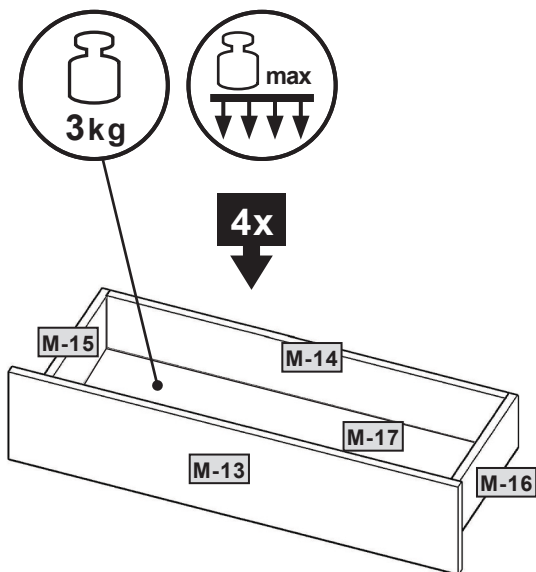

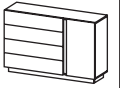

4

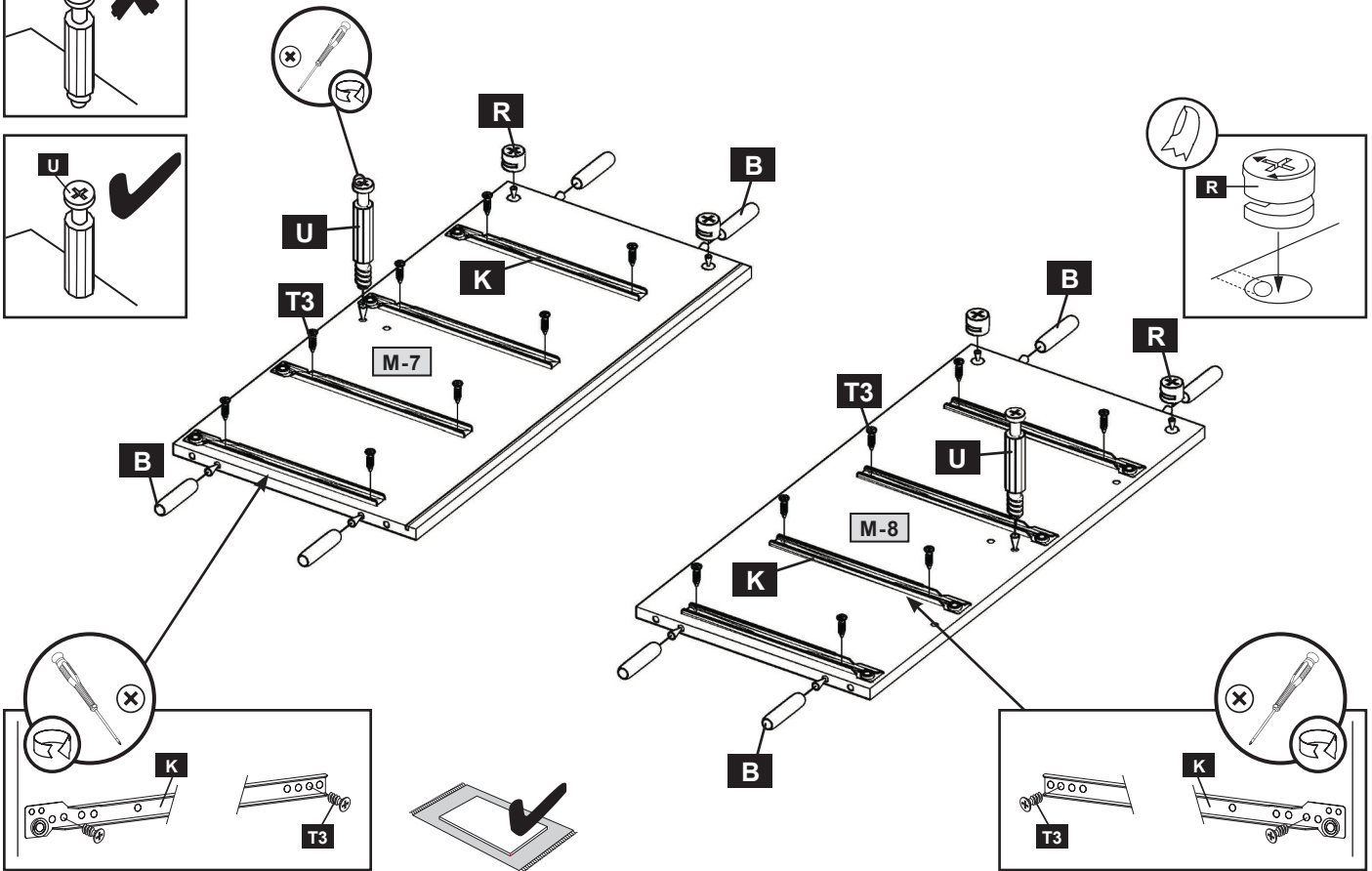
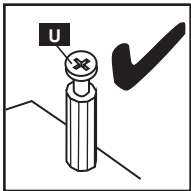
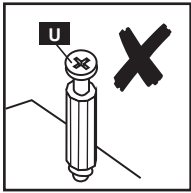
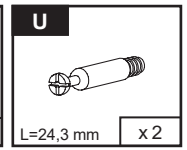
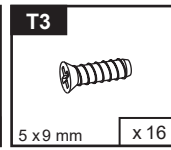
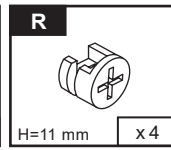
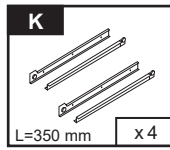
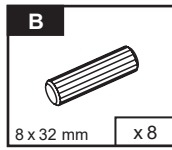

5

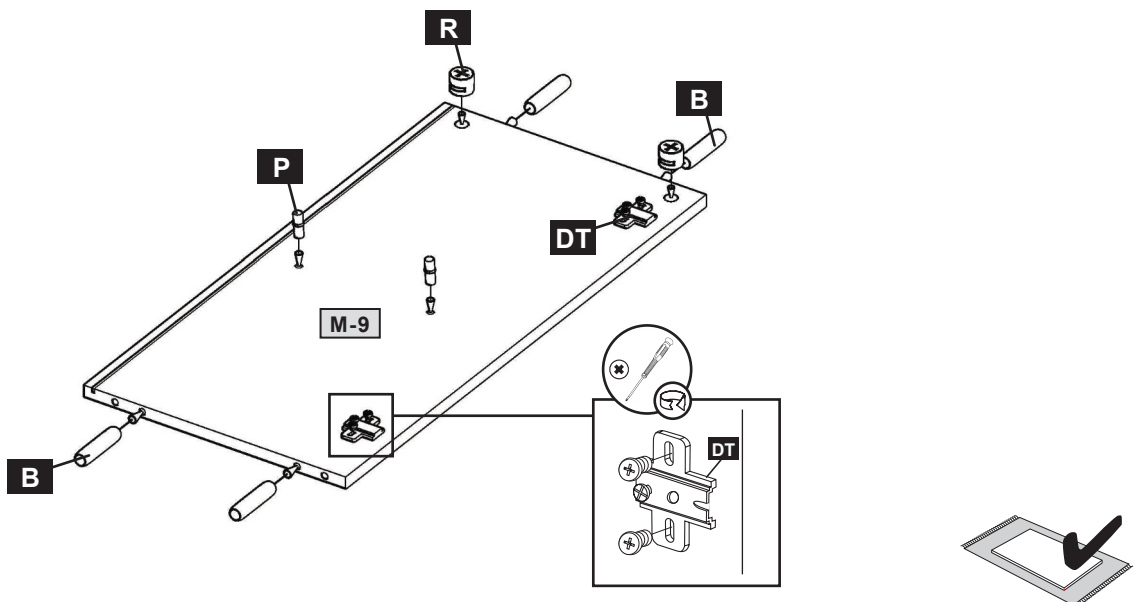
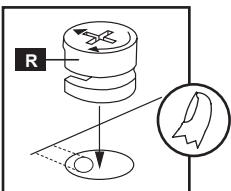
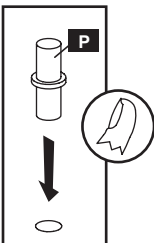
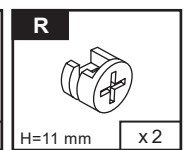
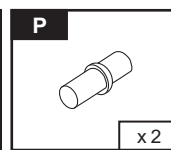
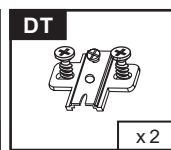
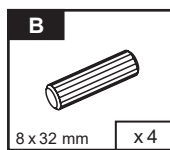

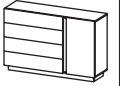

6

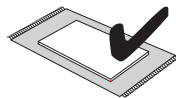
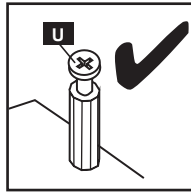
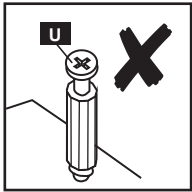
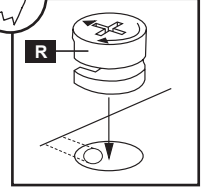
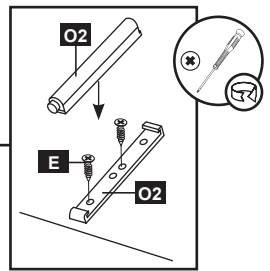
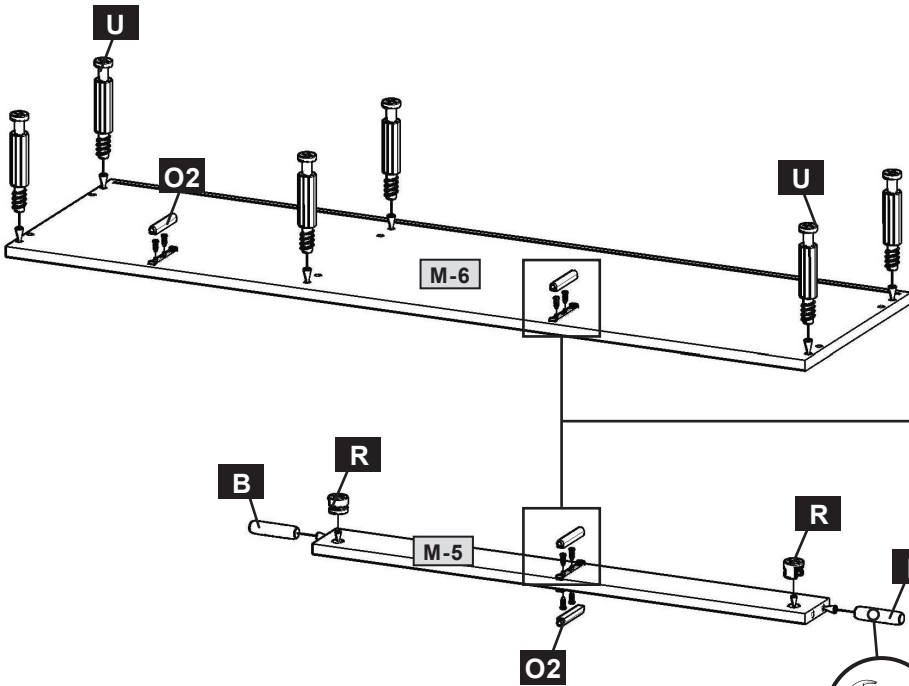
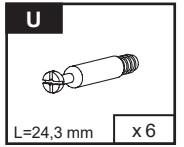
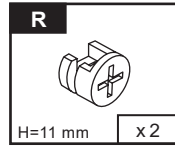
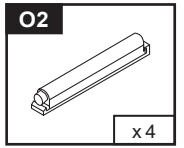
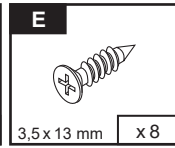
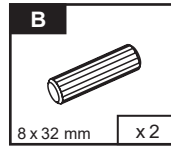

7

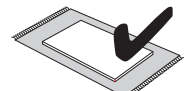
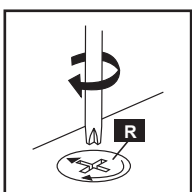
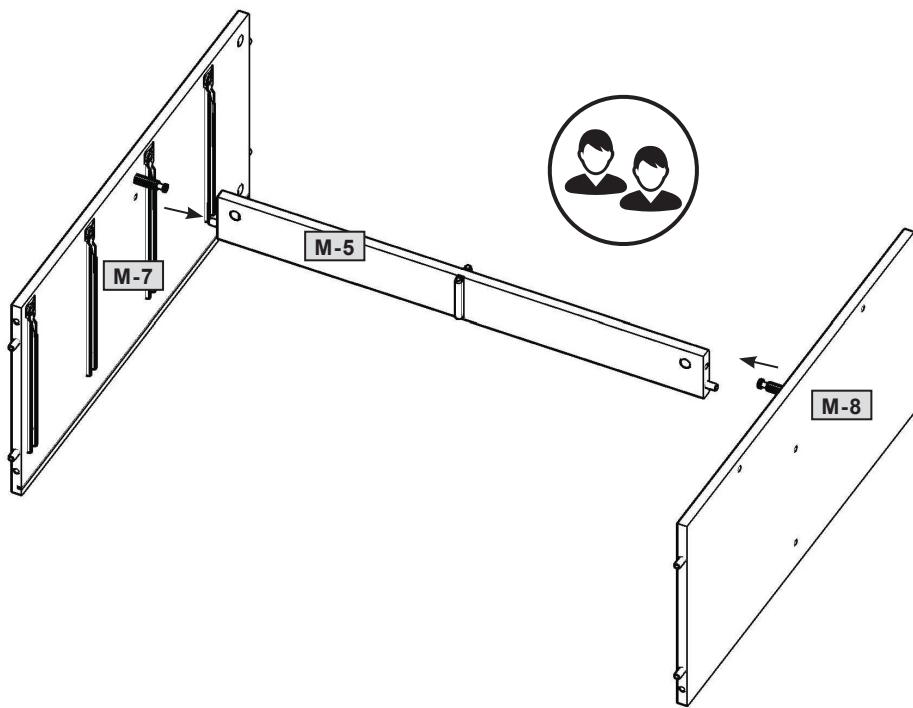

8

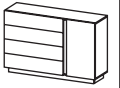

8

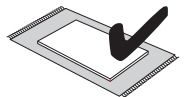
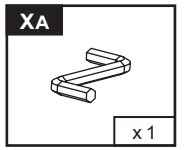
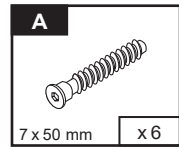
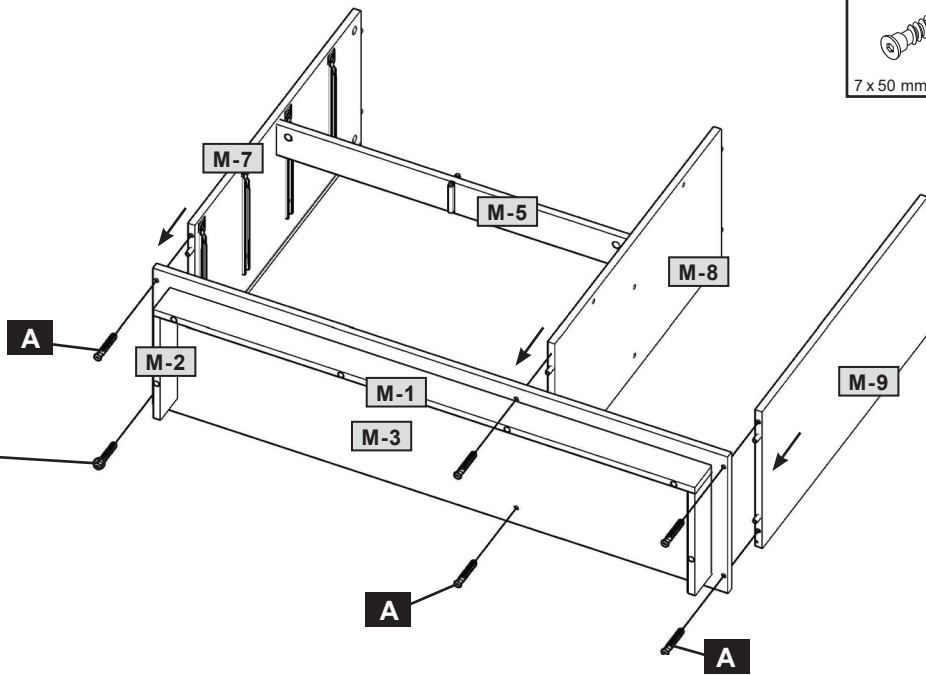
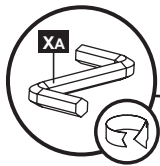

9

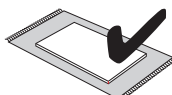
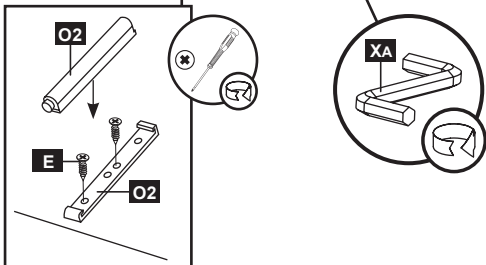
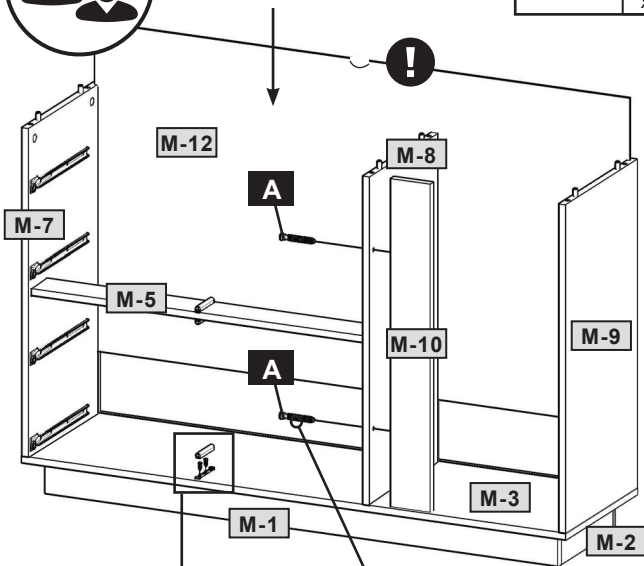
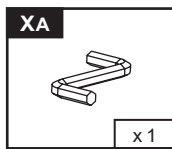
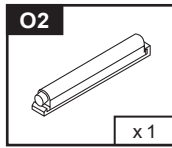
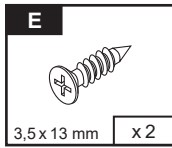
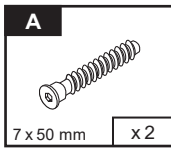

10

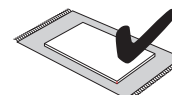
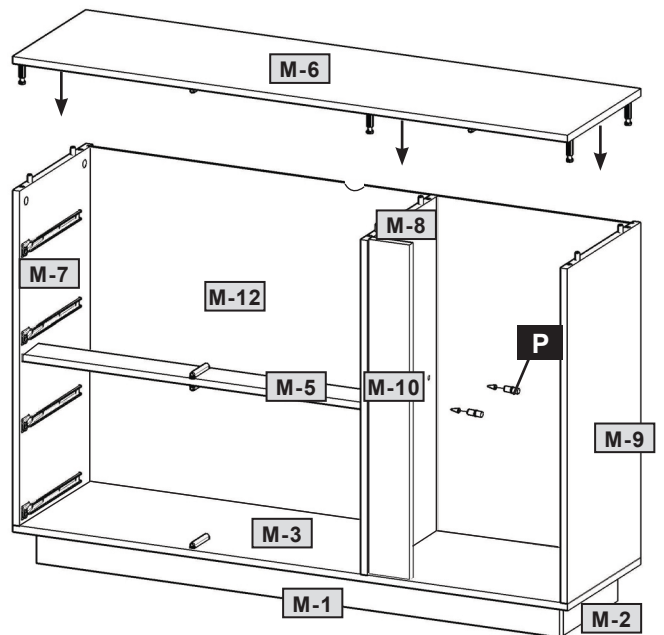
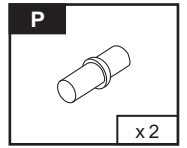
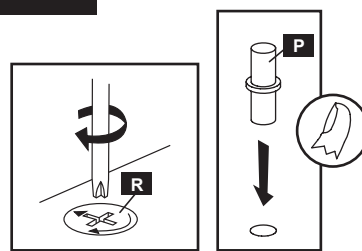

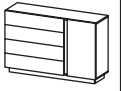

11

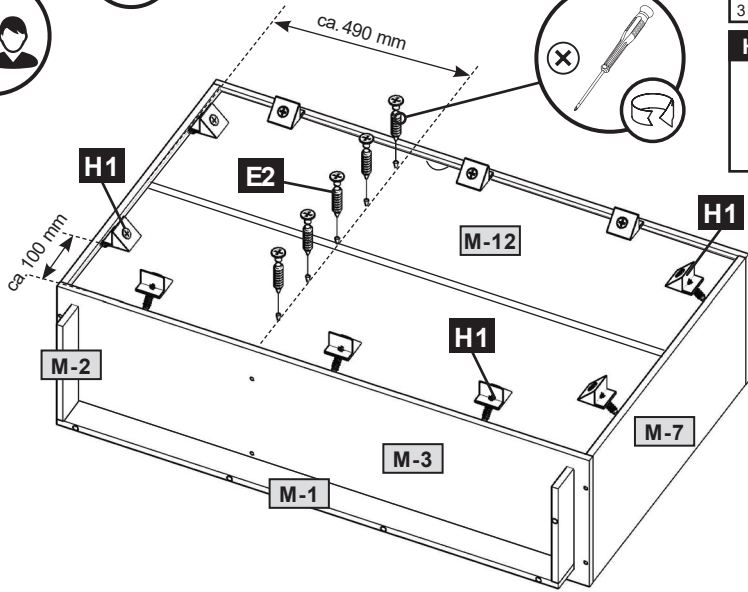
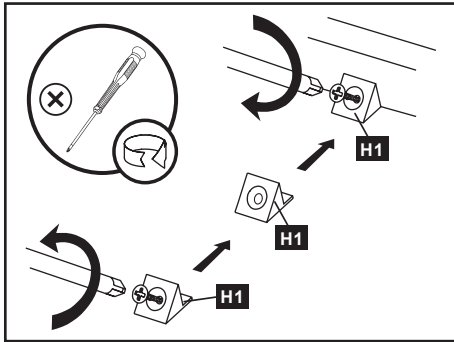
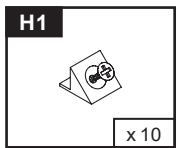
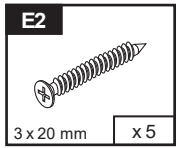
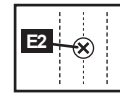
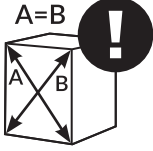
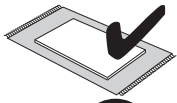

12

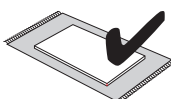
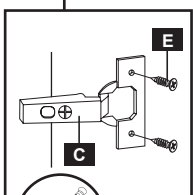
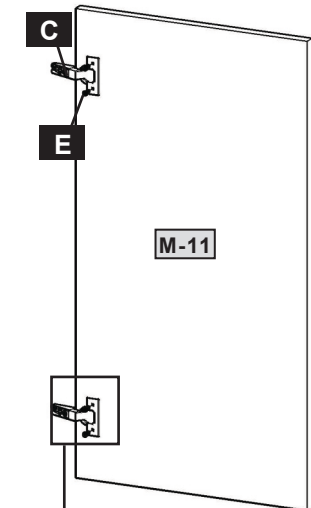
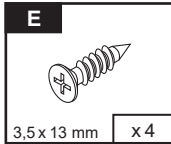
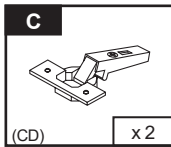

13

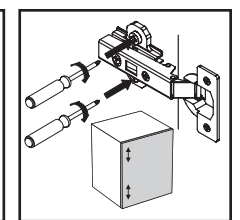
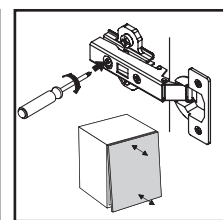
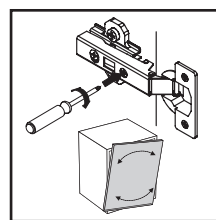
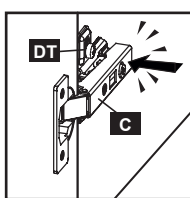
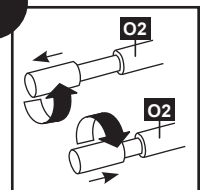
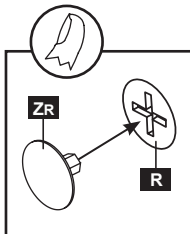
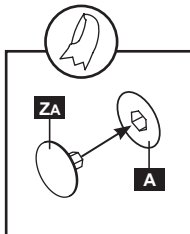
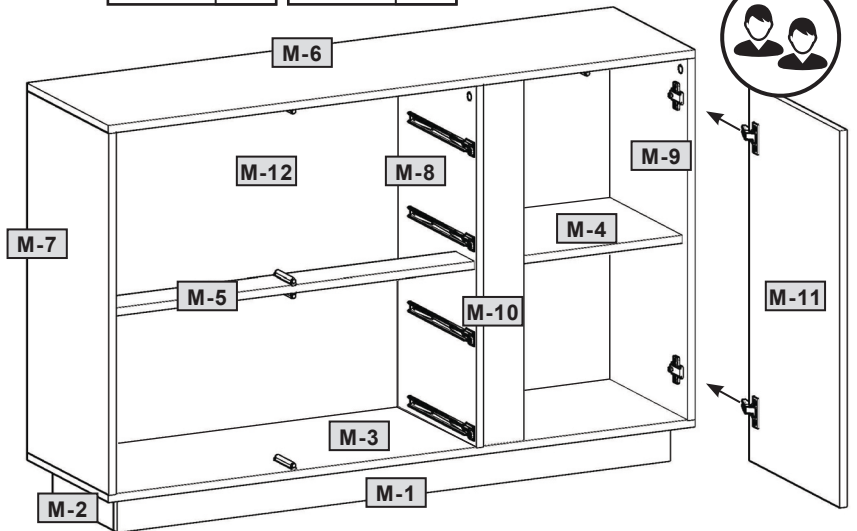
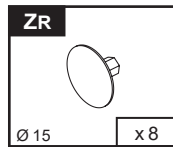
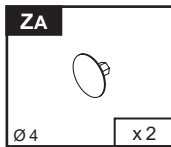

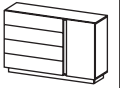

14

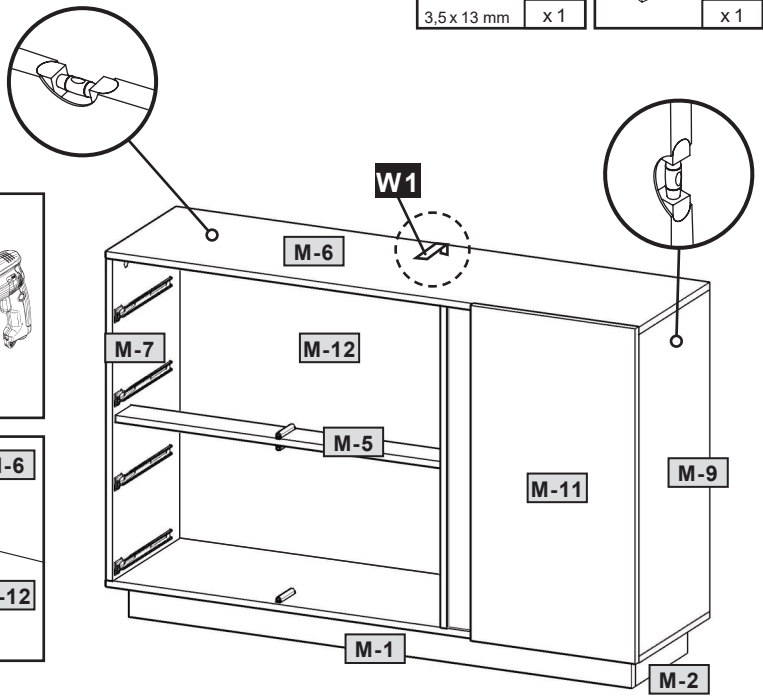
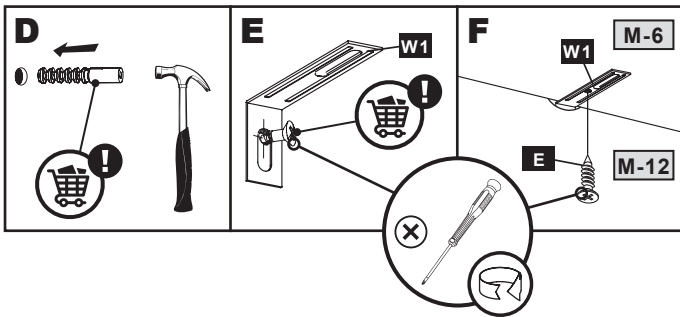
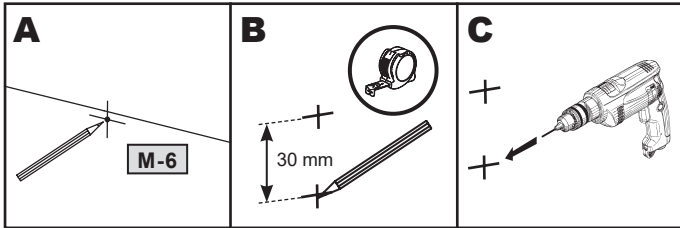
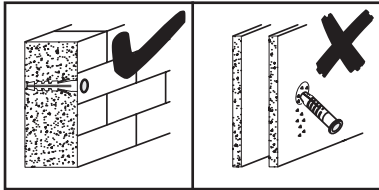
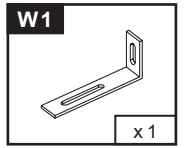
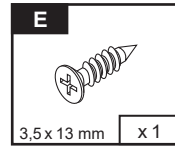

15

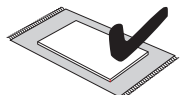
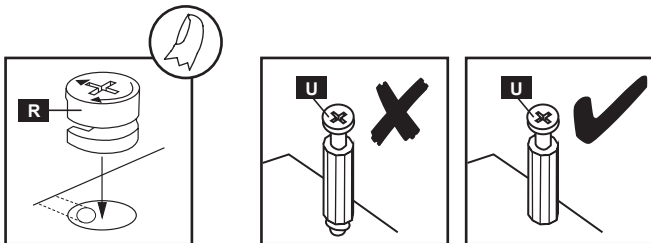
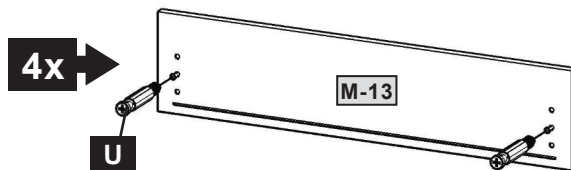
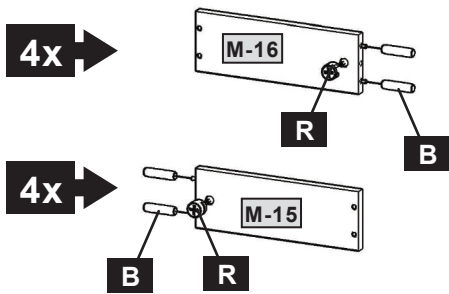
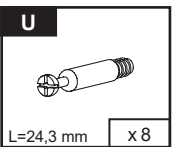
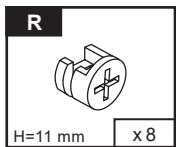
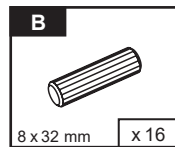

16

4x

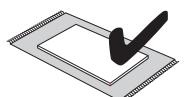
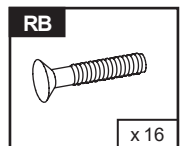
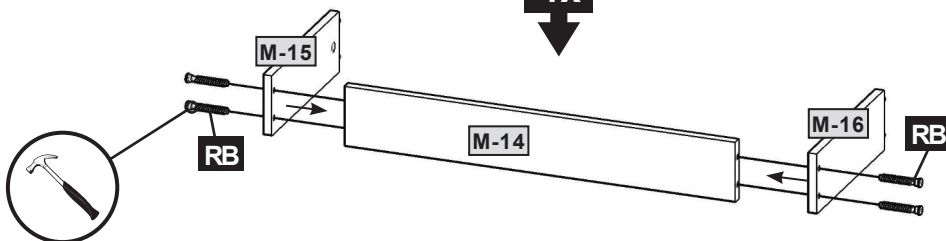

11

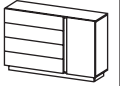

17

4x

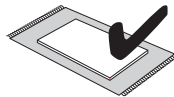
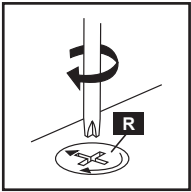
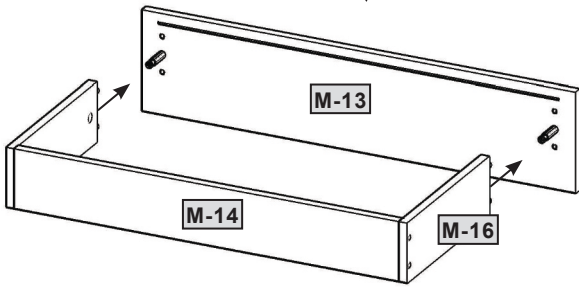

18

4x

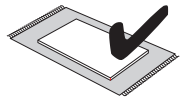
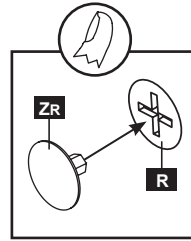
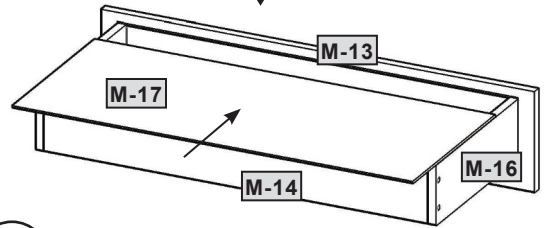
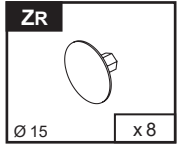

19

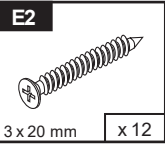

4x

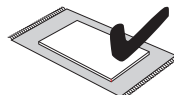
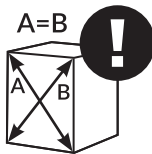
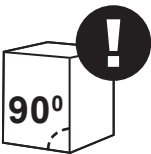
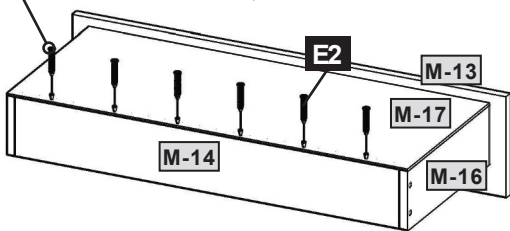

20

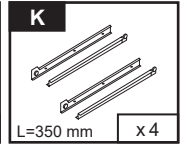
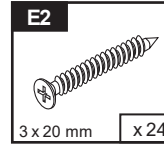
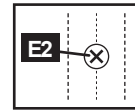

4x

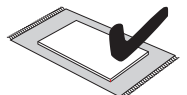
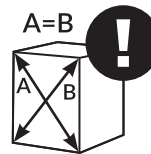
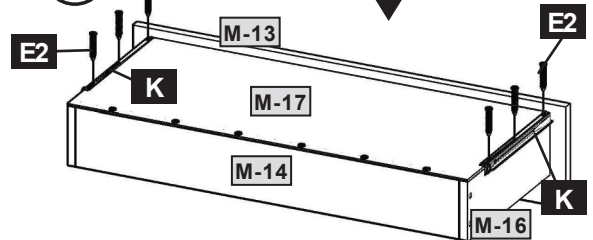

21

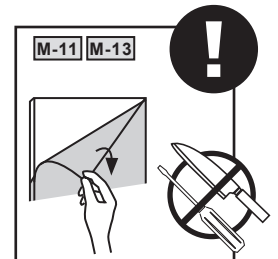
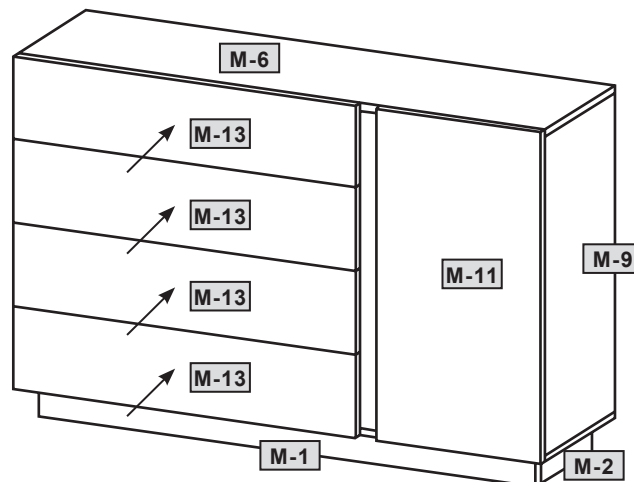
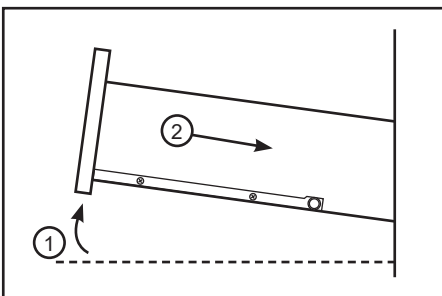

Name • Nom • Nome • Naam • Nazwa • Jméno • Názov • Név • Denumire • Isim • Название

Nr • No • N° • Номер • Č • Sz

Typ • Type • Tip • Típus • Tipo • Tun

M

D

Unser Direktservice für Beschlagteile
Sollte Ihnen ein Beschlagteil fehlen, können Sie diese Servicekarte direkt an die untenstehende Nummer senden. Wir können allerdings nur Beschlagteile auf diesem Weg verschicken. Sollen Sie eine andere Beanstandung an Ihrem Möbelstück haben, so wenden Sie sich bitte direkt an Ihr Möbelhaus.

GB

Our direct order service for fitting
If a fitting should be missing to you, you know this service map directly following number faxes. We can in this way send away however only fitting. If you should have another objection to your piece of furniture, then they turn please to your furniture house.

CZ

Naše přímé služby pro kování
Chybí-li vám nějaký díl z kování, můžete tuto servisní kartu odfaxovat přímo na níže uvedené číslo. Touto cestou však můžeme zoslat jen díly z kování. Pokud byste reklamovali jiný díl nábytku, obraťte se přímo na svého prodejce nábytku.

F

Bien étudier la notice de montage
Respectez les pièces consultant votre meuble. Regroupez et contrôlez la quincaillerie. Munissez-vous de l'outillage nécessaire. Aménagez-vous une zone de montage. Procédez au montage. Ne jamais forcer les assemblages. Resserrez les vis après quelques temps d'usage. Garder votre notice de montage, si une pièce venait à manquer, elle serait le plus clair moyen de communiquer avec votre magasin.

I

Il nostro servizio diretto per l'ordine della ferramenta
Nel caso vi mancassero dei pezzi, potete spedire fax questa carta di servizi direttamente al seguente numero. Per altri reclami al vostro mobile, potete rivolgervi al vostro mobilificio.

BG

Директно обслужаване на фиделите от дил "Обзор"
Ако ви липнеат некои од деловите на мебелот, можете директно да испратите овај сервисен картон на адресата на долу. На овој начин можеме да испратиме само делови за мебелот. Ако имате друга жалба за мебелот, молиме да се обратите директно на вашиот продавач на мебелот.

NL

Onze directservice voor losse onderdelen
Wanneer er een onderdeel mist kunt u deze servicekaart direct aan onderstaand faxnummer sturen. Wij kunnen alleen langs deze weg onderdelen versturen. Mocht u een ander probleem aan uw meubel hebben verzeken wij u contact op te nemen met uw meubeldealer.

PL

Nasz bezpośredni serwis części montażowych
Jeżeli brakuje części koniecznych do montażu, prosimy o przesłanie nam tej karty serwisowej na niżej podany numer faxu. Możemy w ten sposób przysłać państwu tylko brakujące części. W przypadku innych obiekacji dotyczących mebla, prosimy o zgłoszenie ich do salonu meblowego w którym został dokonany zakup.

HR

Servis za okove
U slučaju da nedostaje neki od dijelova molimo vas da na dole navedeni Fax broj posaljete ovaj servisni obrazac. Na ovaj način mogu se dostaviti samo okovi. U slučaju da imate dodatne prigovore vezane uz komad namještaja molimo vas da se obratite izravno trgovini namještaja gdje je isti kupljen.

HU

Direktszolgáltatunk vasalatoik esetén
Ha hiányzik egy vasalat, ezt a kártyát közvetlenül elfaxolhatja az alább található faxszámra. Azonban csakis vasalatoikat tudunk így küldeni. Amennyiben másféle reklamációt áll fenn bútordarabjait illetően, forduljon közvetlenül a bútornáhhöz.

SK

Naše priamy servis pre železnú kovanie
Ak by Vám chýbala nejaká časť kovania, môžete poslať túto servisnú kartu poslať faxom priamo na nižšie uvedené faxové číslo. Díly kovania vieme poslať iba týmto spôsobom. Ak by ste mali inú reklamáciu ohľadom Vašho nábytku, obraťte sa priamo na Vašu predajnú nábytku.

SLO

Naše direktno služne storitve za okovje
Če vam manjka kakšno okovje, lahko to servisno kartico pošljete po faxu direktno na spodnjo številko. Po tej poti vam lahko pošljemo samo okovje. Če želite reklamirati kakšen drug del pohištva, se obrnite neposredno na vašo trgovino pohištva.

RO

Service-ul nostru direct pentru feronerie
In cazul in care va lipseste o piesa de feronerie puteti sa trimitezi direct acest card de service pe fax la numarul de mai jos. Noi nu putem expedia piese de feronerie decat pe acest fel de cale. Decat avezi o alta reclamatie referitoare la piesa de mobilier, atunci va rugam sa va adresati direct la magazinul dvs. de mobilier.

RUS

Наш прямой сервис для поставок фурнитуры
Если окажется, что Вам не хватает того или иного элемента фурнитуры, Вы можете отправить сервисную карту по факсу непосредственно на нижеприведенный номер. Однако, таким образом мы можем пересылать лишь фурнитуру. Если же у Вас возникнут иные претензии относительно приобретенной мебели, пожалуйста, обращайтесь непосредственно в организацию, осуществляющую продажу.

S







Vår direktservice för beslagdelar
Om du saknar en beslagdel kan du faxa detta servicekort direkt till numret som anges ned. Tänk på att detta är den enda möjligheten att skicka beslagdelar till dig. Om du vill reklamera din möbel av en annan anledning måste du kontakta ditt möbelhus direkt.

ES

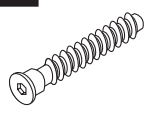
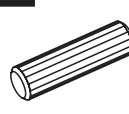
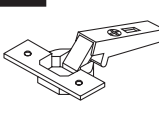
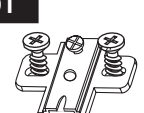
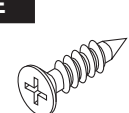
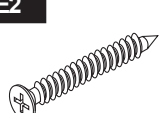
Nuestro servicio directo para accesorios
Si le falta algún accesorio, puede enviar esta tarjeta de servicio directamente a la siguiente dirección. No obstante, por este método solo podemos enviar accesorios. Si tiene alguna otra objeción sobre su mueble, consulte directamente con su mueblería.

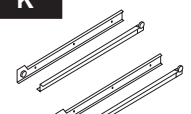
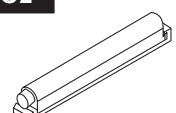
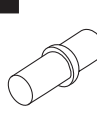
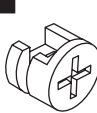
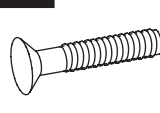
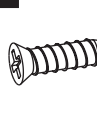
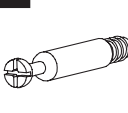
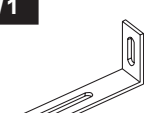
TR

Donatılar için doğrudan servisliz
Bir donatınız eksikse bu servis kartını doğrudan aşağıda bulunan adrese doğrudan mail yazabilirsiniz. Sadece bu yolla donatılar gönderilebilir. Mobilyanızda başka şikayetleriniz varsa lütfen doğrudan mobilya satıcınıza danışın.

A  7 x 50 mm X ...	B  8 x 32 mm X ...	C  (CD) X ...
DT  X ...	E  3,5 x 13 mm X ...	E2  3 x 20 mm X ...
G2  X ...	H1  X ...	K  L=350 mm X ...
O2  X ...	P  X ...	R  H=11 mm X ...
RB  X ...	T3  5 x 9 mm X ...	U  L=24,3 mm X ...
W1  X ...	XA  X ...	XG  X ...
ZA  Ø 4 X ...	ZR  Ø 15 X ...	

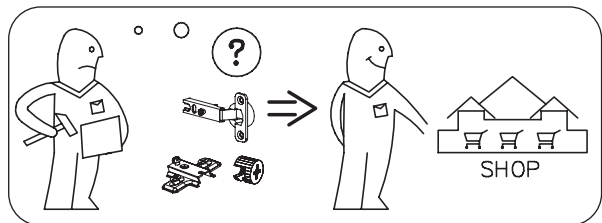
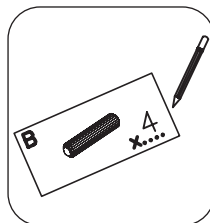

Name • Nom • Nome • Naam • Nazwa • Jméno
• Názov • Név • Denumire • Isim • Имя

Nr • No • N° • Номер • Č • Sz

Typ • Type • Tip • Típus • Tipo • Tun

— —

M

D

Unser Direktservice für Beschlagteile
Sollte Ihnen ein Beschlagteil fehlen, können Sie diese Servicekarte
direct an die untenstehende Nummer senden. Wir können allerdings
nur Beschlagteile auf diesem Weg verschicken. Sollen Sie eine andere
Beanstandung an Ihrem Möbelstück haben, so wenden Sie sich bitte
direkt an Ihr Möbelhaus.

GB

Our direct order service for fitting
If a fitting should be missing to you, you know this service map
directly following number faxes. We can in this way send away
however only fitting. If you should have another objection to your
piece of furniture, then they turn please to your furniture house.

CZ

Naše přímé služby pro kování
Chybí-li vám nějaký díl z kování, můžete tuto servisní kartu odfaxovat
přímo na níže uvedené číslo. Touto cestou však můžeme zaslát jen
díly kování. Pokud byste reklamovali jiný díl nábytku, obraťte se přímo
na svého prodejce nábytku.

F

Bien étudier la notice de montage
Respectez les pièces consultant votre meuble. Regroupez et contrôlez la
quincaillerie. Munissez - vous de l'outillage nécessaire. Aménagez -
vous une zone de montage. Procédez au montage. Ne jamais forcer
les assemblages. Resserrez les vis après quelques temps d'usage.
Garder votre notice de montage, si une pièce venait à manquer, elle
serait le plus clair moyen de communiquer avec votre magasin.

I

Il nostro servizio diretto per l'ordine della ferramenta
Nel caso vi mancassero dei pezzi, potete spedire fax questa carta di
servizi direttamente al seguente numero. Per altri reclami al vostro
mobile, potete rivolgervi al vostro mobilificio.

BG

Директно обслужаване на електричките "Обзор"
Ако ви липнева некои од деловите, можете да ја испратите овај сервисен
карт на адресата на долу наведеното. По овај начин може да се испратат
само деловите. Ако имате друга жалба на мебелот, молиме директно да се
обратите на вашиот продавач на мебел.

NL

Onze directservice voor losse onderdelen
Wanneer er een onderdeel mist kunt u deze servicekaart direct aan
onderstaand faxnummer sturen. Wij kunnen alleen langs deze weg
onderdelen versturen. Mocht u een ander probleem aan uw meubel
hebben verzoeken wij u contact op te nemen met uw meubeldealer.

PL

Nasz bezpośredni serwis części montażowych
Jeżeli brakuje części koniecznych do montażu, prosimy o przesłanie
nam tej karty serwisowej na niżej podany numer faxu. Możemy w ten
sposób przysłać państwu tylko brakujące części. W przypadku innych
objawów dotyczących mebla, prosimy o zgłoszenie ich do salonu
meblowego w którym został dokonany zakup.

HR

Servis za okove
U slučaju da nedostaje neki od dijelova molimo vas da na dolje
navedeni Fax broj posaljete ovaj servisni obrazac. Na ovaj način mogu se
dostaviti samo okovi. U slučaju da imate dodatne prigovore vezane
uz komad namještaja molimo vas da se obratite izravno trgovini
namještaja gdje je isti kupljen.

HU

Direktszolgálatunk vasalatók esetén
Ha hiányzik egy vasalató, ezt a kártyát közvetlenül elfaxolhatja az alább
tárolható faxszámra. Azonban csak a vasalatókat tudunk így küldeni.
Amennyiben másféle reklamáció áll fenn bútorarabjait illetően,
forduljon közvetlenül a bútorházzal.

SK

Naše priamy servis pre časti kovania
Ak by Vám chýbala nejaká časť kovania, môžete poslať túto servisnú
kártyu poslať faxom priamo na nižšie uvedené faxové číslo. Diely
kovania vieme poslať iba týmto spôsobom. Ak by ste mali inú
reklamáciu ohľadom Vášho nábytku, obráťte sa priamo na Vašu
predajnú nábytku.

SLO

Naše direktno služne storitve za okovje
Če vam manjka kakšno okovje, lahko to servisno kartico pošljete po
faksu direktno na spodnjo številko. Po tej poti vam lahko pošljemo
samo okovje. Če želite reklamirati kakšen drug del pohištva, se obrnite
neposredno na vašo trgovino pohištva.

RO

Service-ul nostru direct pentru feronerie
In cazul in care va lipseste o piesa de feronerie puteti sa trimitezi
direct acest card de service pe fax la numarul de mai jos. Noi nu
putem expedia piese de feronerie decat pe acestasi cale. Decat aveți o
altă reclamație referitoare la piese de mobilier, atunci vă rugăm să vă
adresați direct la magazinul dvs. de mobilă.

RUS

Наш прямой сервис для поставок фурнитуры
Если окажется, что Вам не хватает того или иного элемента
фурнитуры, Вы можете отправить сервисную карту по Факсу
непосредственно на нижеприведенный номер. Однако, таким
образом мы можем пересылать лишь фурнитуру. Если же у Вас
возникнут иные претензии относительно приобретенной мебели,
пожалуйста, обращайтесь непосредственно в организацию,
осуществляющую продажу.

S

Vår direktservice för beslagdelar
Om du saknar en beslagdel kan du faxa detta servicekort direkt till
numret som anges ned. Tänk på att detta är den enda möjligheten att
skicka beslagdelar till dig. Om du vill reklamera din möbel av en
annan anledning måste du kontakta ditt möbelhus direkt.

ES

Nuestro servicio directo para accesorios
Si le falta algún accesorio, puede enviar esta tarjeta de servicio
directamente a la siguiente dirección. No obstante, por este método
solo podemos enviar accesorios. Si tiene alguna otra objeción sobre su
mueble, consulte directamente con su mueblería.

TR

Donatilar için doğrudan servisimiz
Bir donatınız eksikse bu servis kartını doğrudan aşağıda bulunan
adrese doğrudan mail yazabilirsiniz. Sadece bu yölla donatılar
gönderebiliriz. Mobilyanızda başka şikayetleriniz varsa lütfen doğrudan
mobilya satıcınıza danışın.

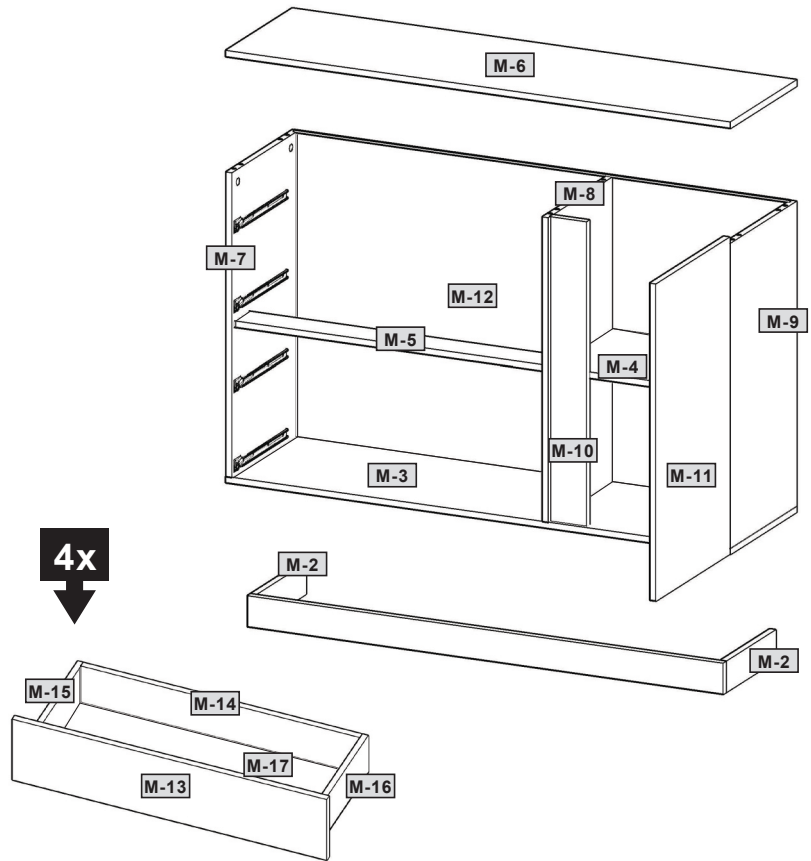

nr	↔ [mm]	↑ [mm]	∠ [mm]	Menge	Colli
M-1	1302	80	16	x 1	1/2
M-2	288	80	16	x 2	1/2
M-3	1381	384	16	x 1	1/2
M-4	482	343	16	x 1	1/2
M-5	850	100	16	x 1	1/2
M-6	1381	384	16	x 1	1/2
M-7	790	384	16	x 1	2/2
M-8	790	369	16	x 1	2/2
M-9	790	384	16	x 1	2/2
M-10	100	790	16	x 1	1/2
M-11	426	822	16	x 1	2/2
M-12	1363	805	3	x 1	1/2
M-13	894	202	16	x 4	1/2
M-14	794	120	16	x 4	1/2
M-15	350	120	16	x 4	1/2
M-16	350	120	16	x 4	1/2
M-17	823	356	16	x 4	2/2

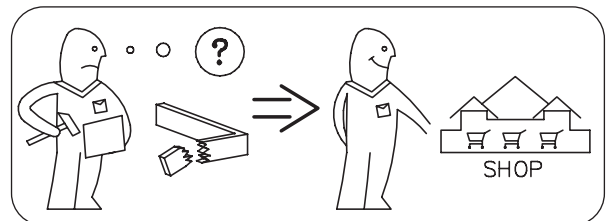



Uwaga - Upozornění - Achtung - Attention - Caution - Figyelem
 Attenzione - Opgelet - Atenție - Upozornenie - Dikkat

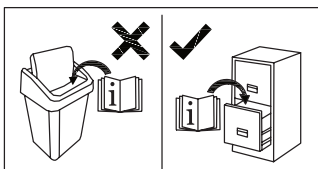
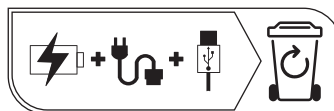
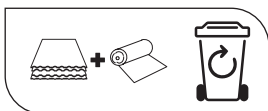
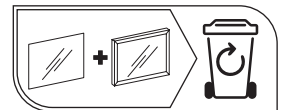
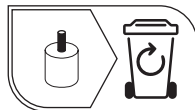
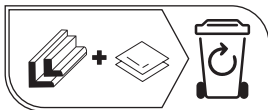
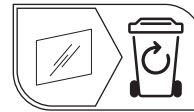
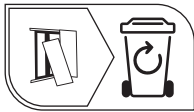
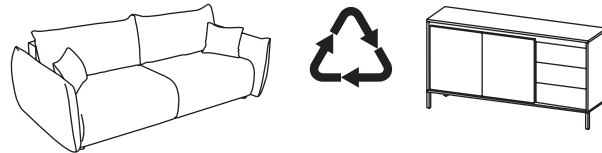
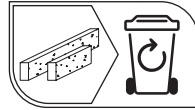
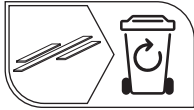
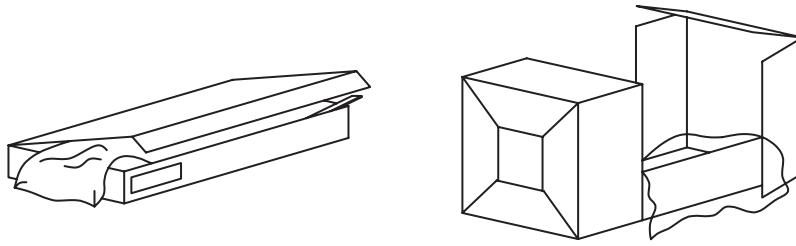

Producent - Produzent - Üretici - Producteur - Výrobce -
 Termelő - Producer - Produttore - Producător - Productor
MEBLE LASKI KACZOROWSKAPSK.
 Laski, ul. Kępińska 21, 63-620 Trzcinica
 meble-laski@meble-laski.com.pl

