

120 min

ELENA 2D-L

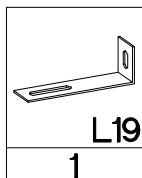
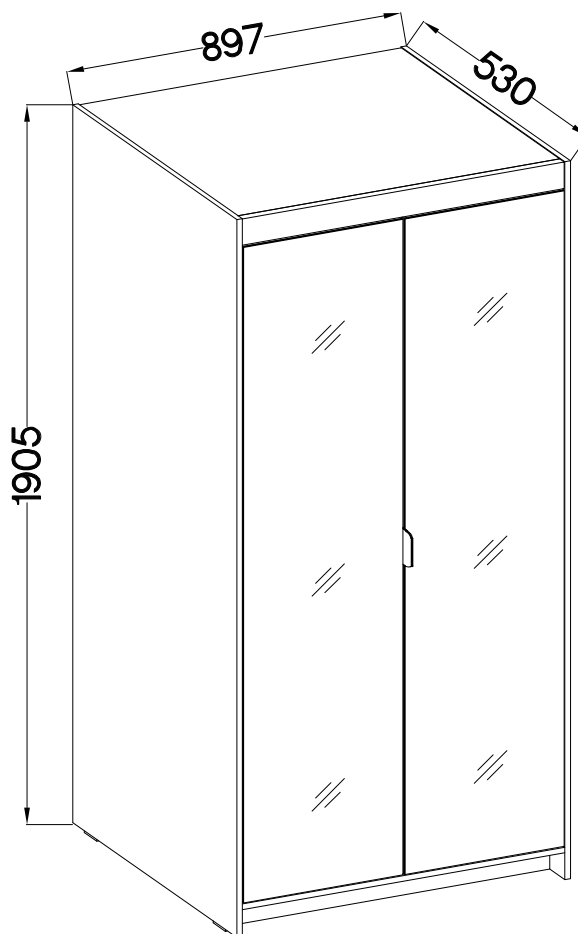
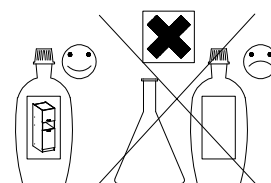

L19

1

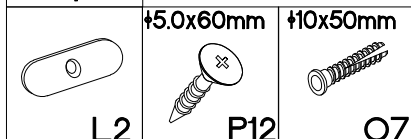

L2

±5.0x60mm

±10x50mm

P12

O7

14

1

1



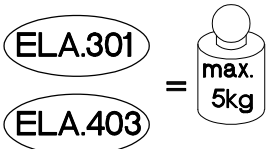
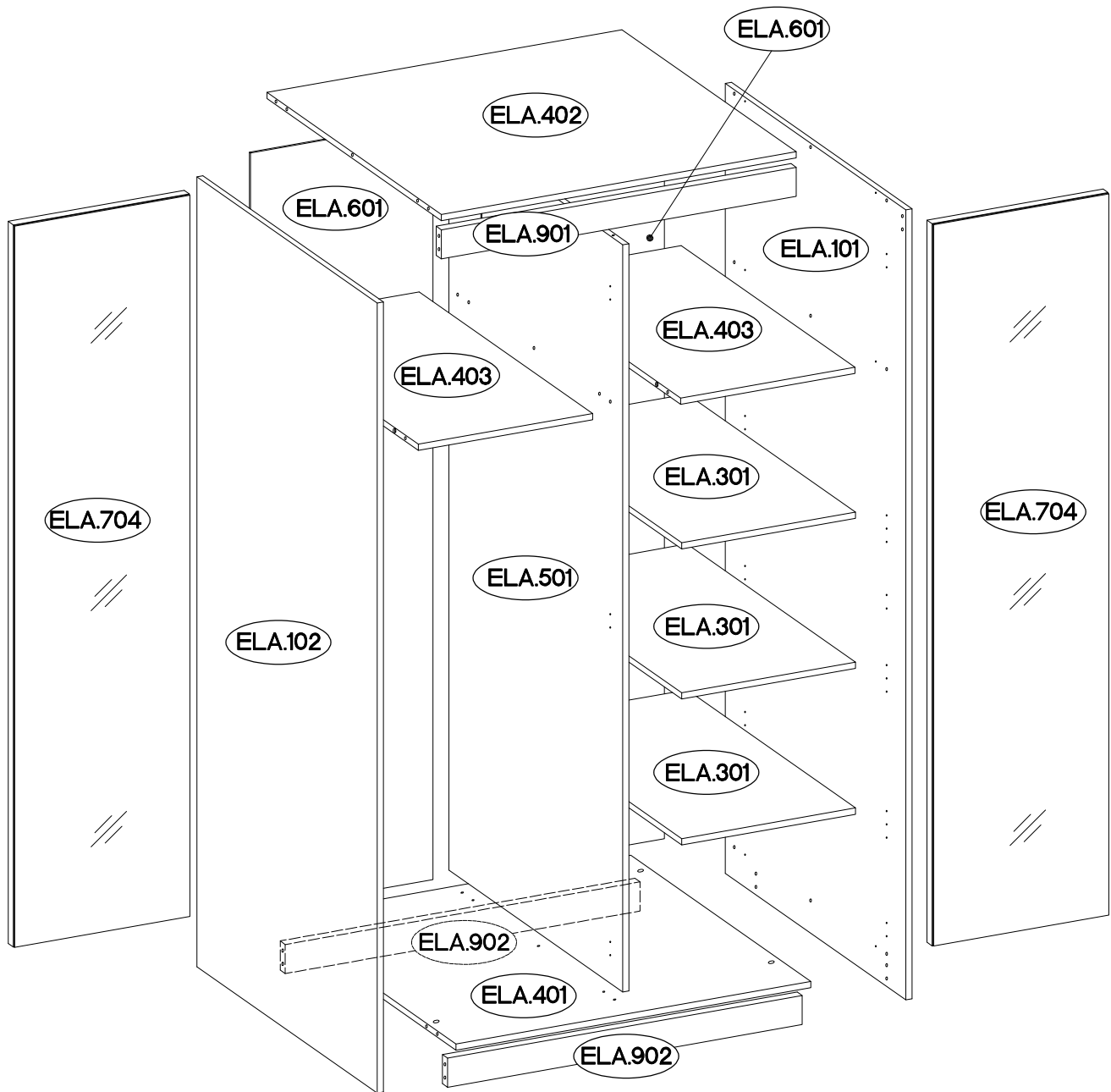

±35/16mm	H=0	±3.5x13mm	L=56mm	6.5x48x16	L=418mm		±5/16mm
G2	H	P5	D4	F2	J2	J17	J3
6	6	16	2	4	1	2	12
±15/12mm		±8x30mm	L=20mm	L=64mm	±3.0x20mm	±15x5mm	
C	E	A	D2	S	P7	F4	
20	20	42	16	2	57	2	

P-ISM-ELA-12



Colli	Ersatzteil Nummer	Dimension
Colli 1/2	ELA.102	1900x530x15
	ELA.301 x3	425x495x15
	ELA.401	867x529x15
	ELA.402	867x512x15
	ELA.403 x2	426x510x15
	ELA.901	867x70x15
	ELA.902 x2	867x70x15

Colli	Ersatzteil Nummer	Dimension
Colli 2/2	ELA.101	1900x530x15
	ELA.501	1797x511x15
	ELA.601 x2	1825x446x2,5
	ELA.704 x2	1737x430x18

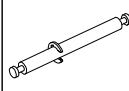
∅5/12mm	∅8x30mm	L=20mm	∅15x5mm	6.5x48x16	L=56mm
					
C	A	D2	F4	F2	D4
20	42	16	2	4	2

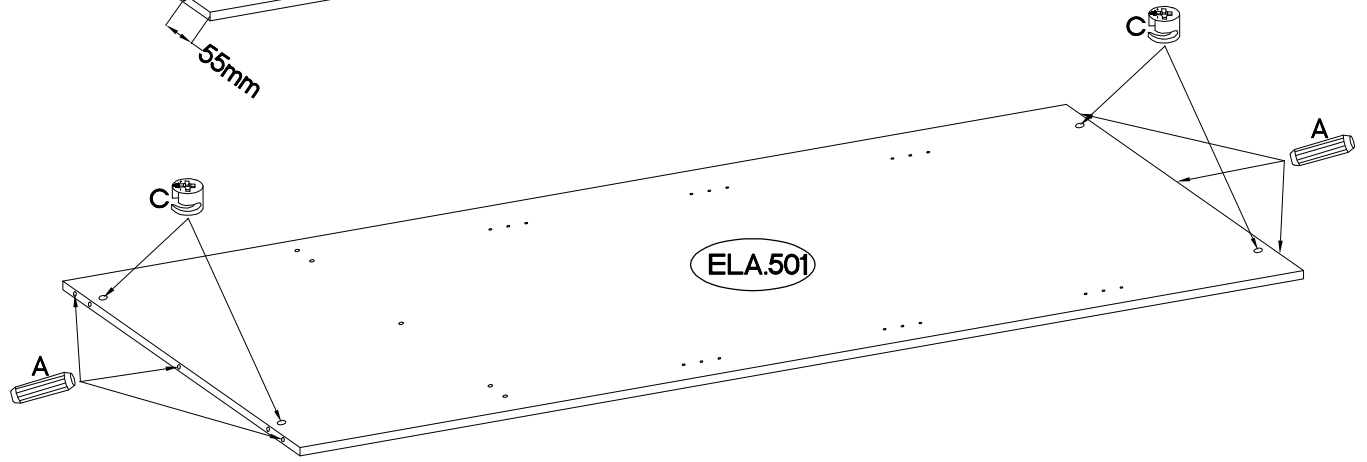
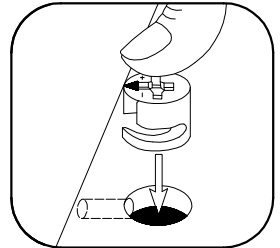
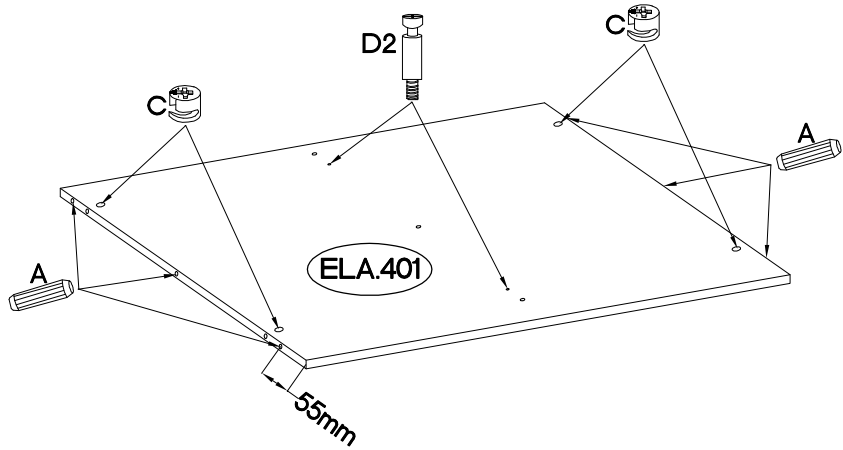
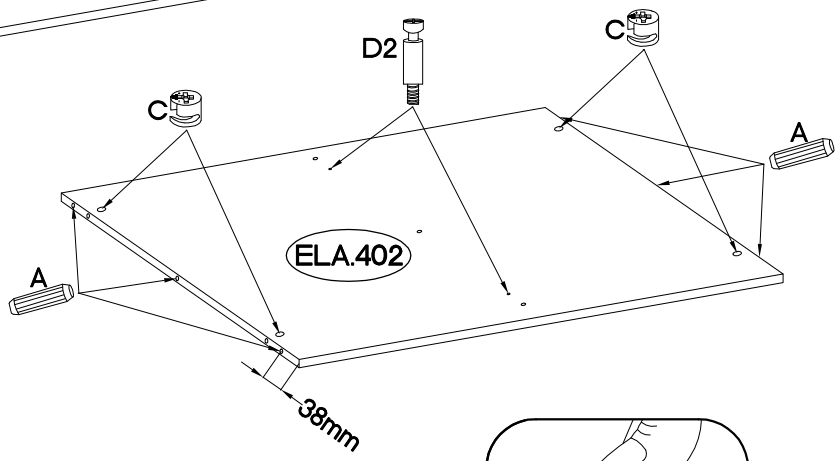
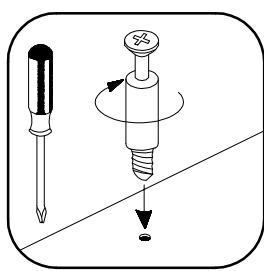
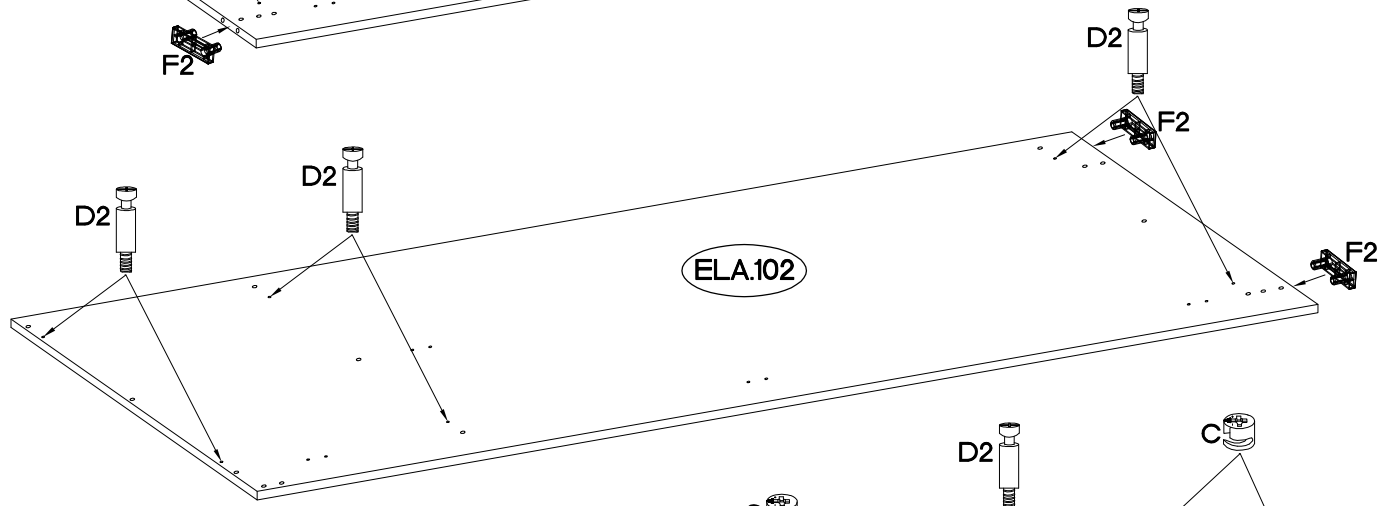
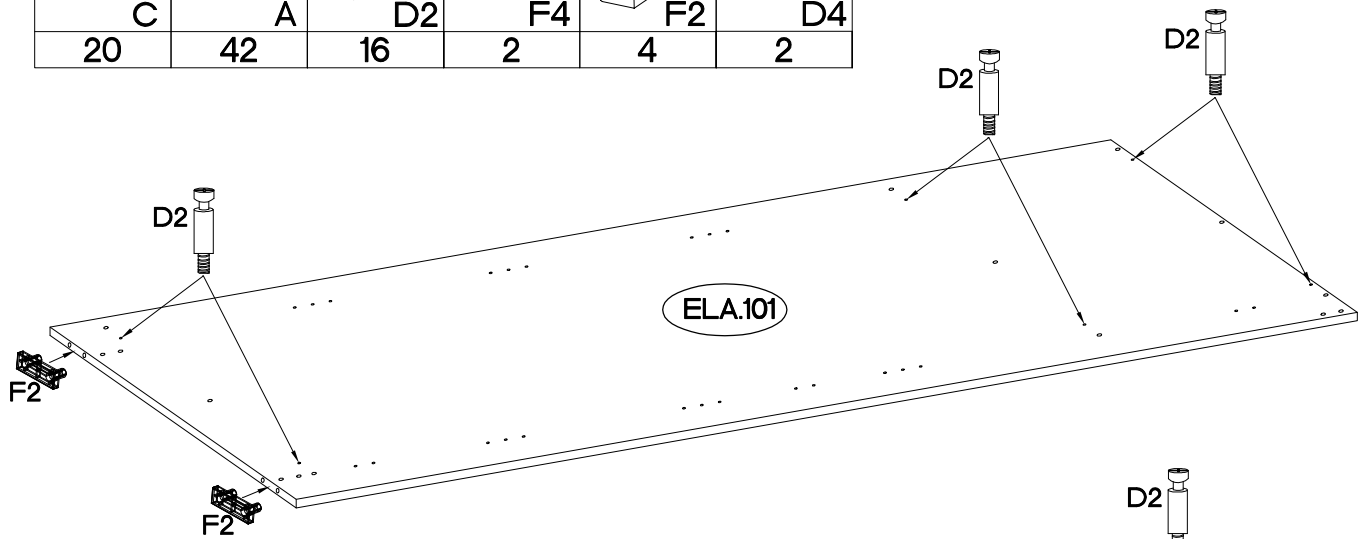

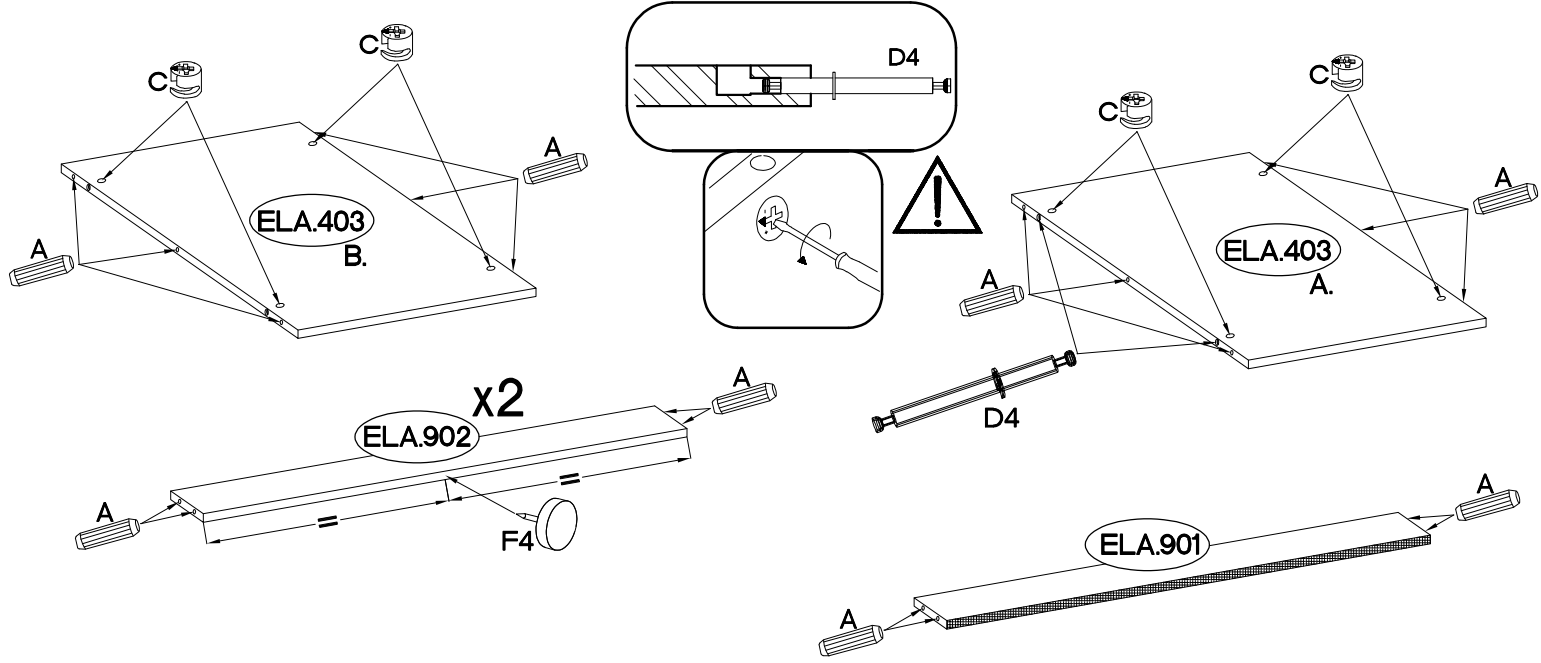

2

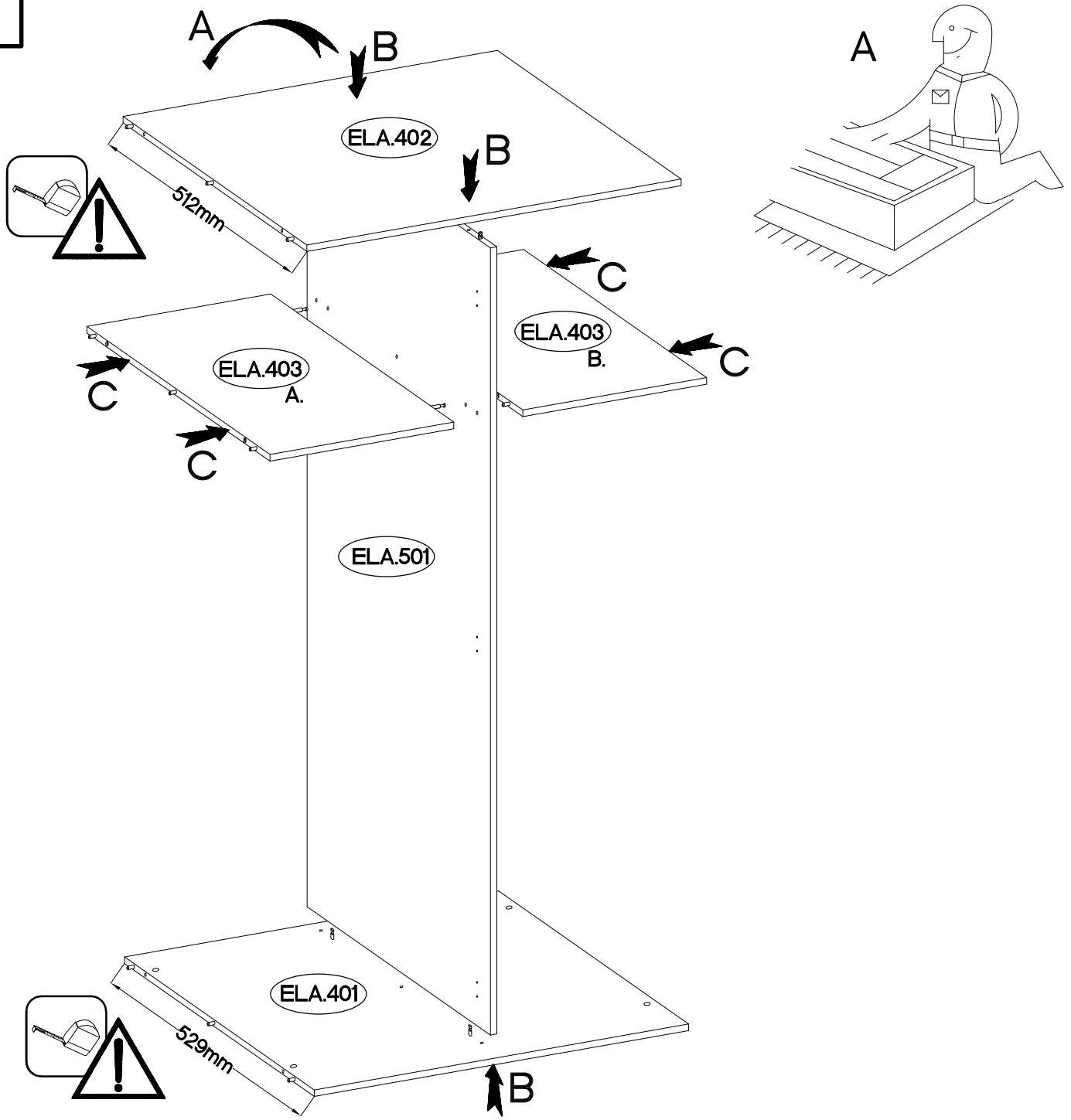

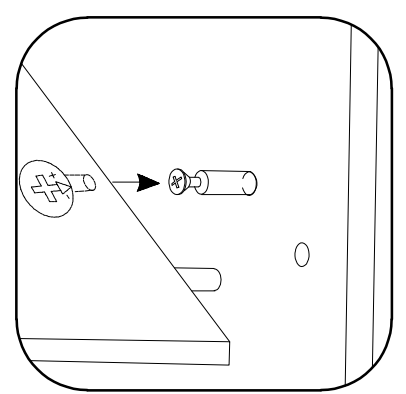
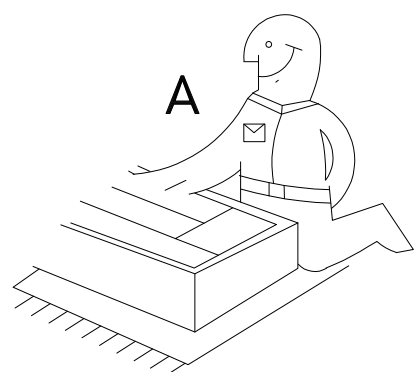
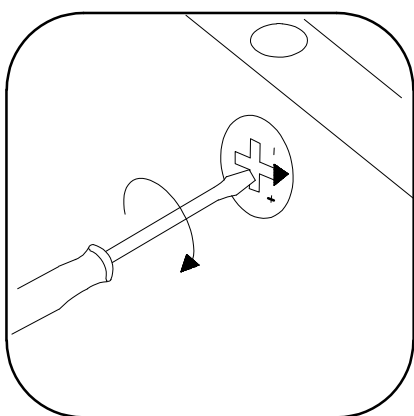
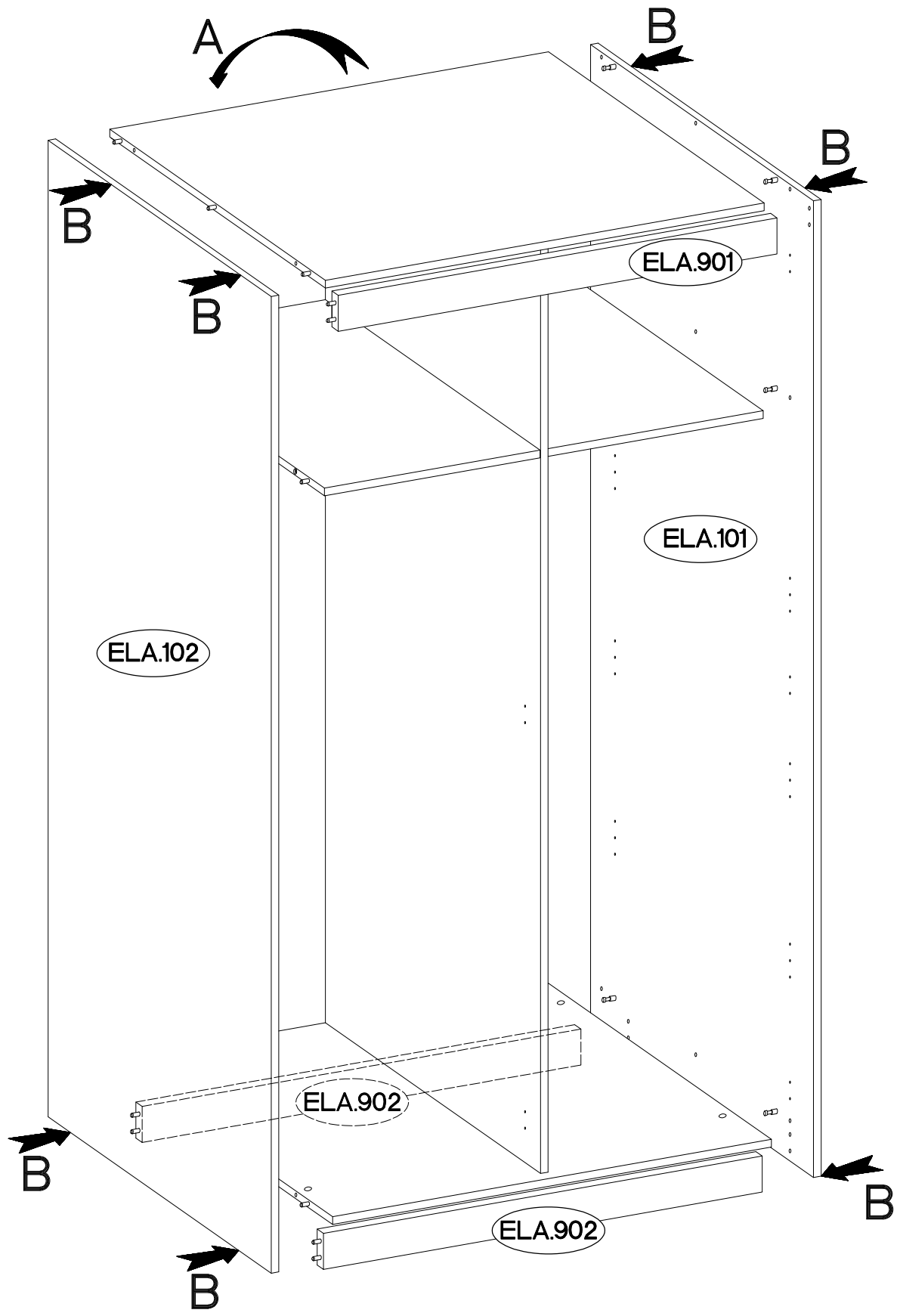

3

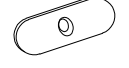

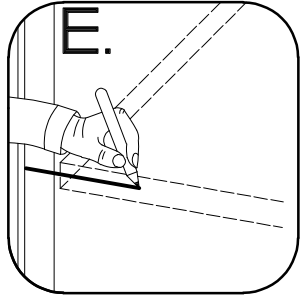
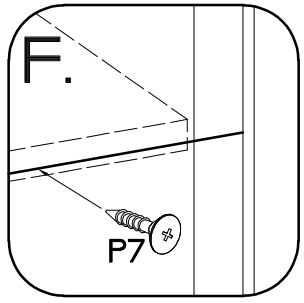
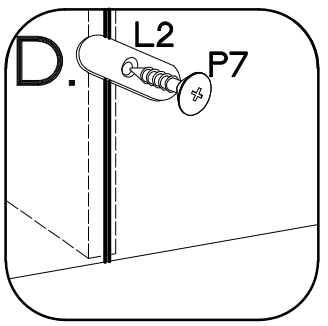
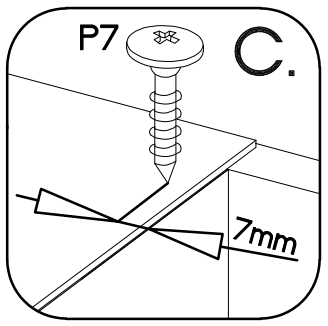
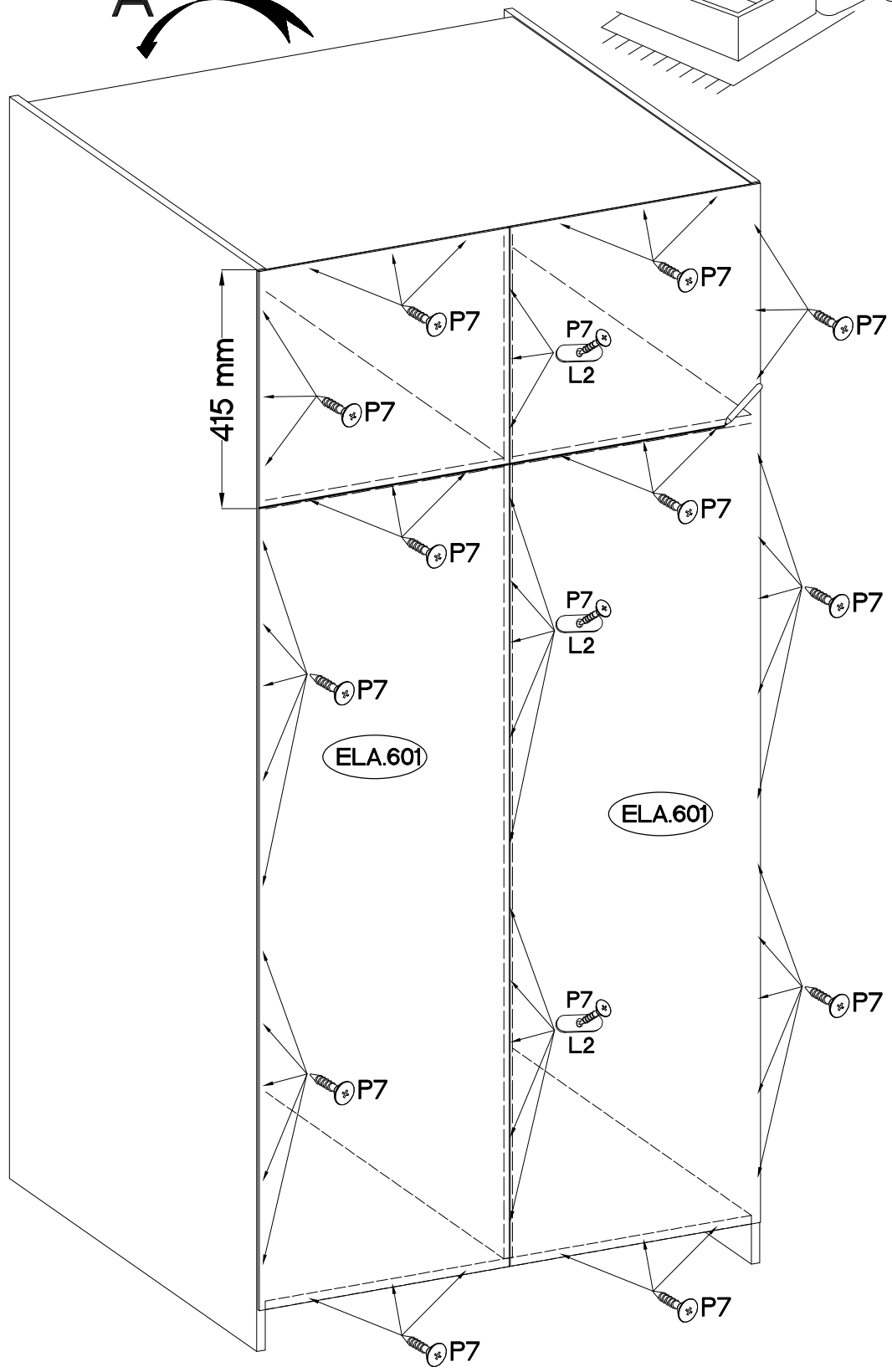
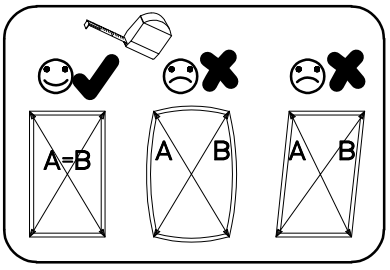
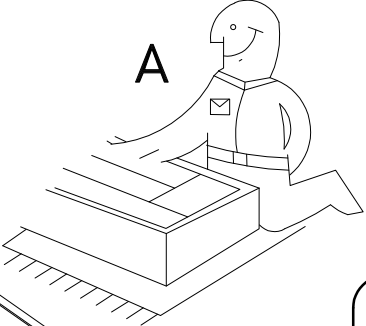

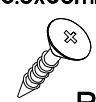

	±3.0x20mm
L2	P7
14	57

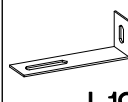

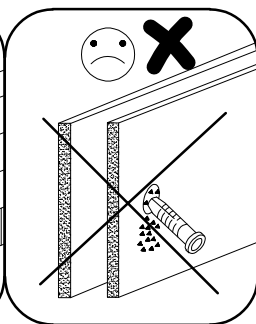
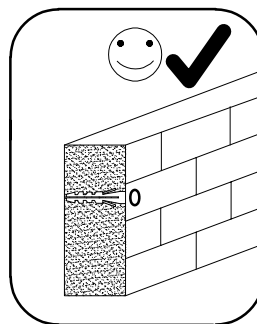
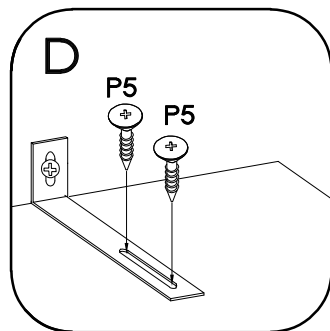
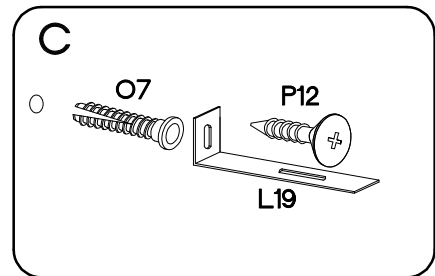
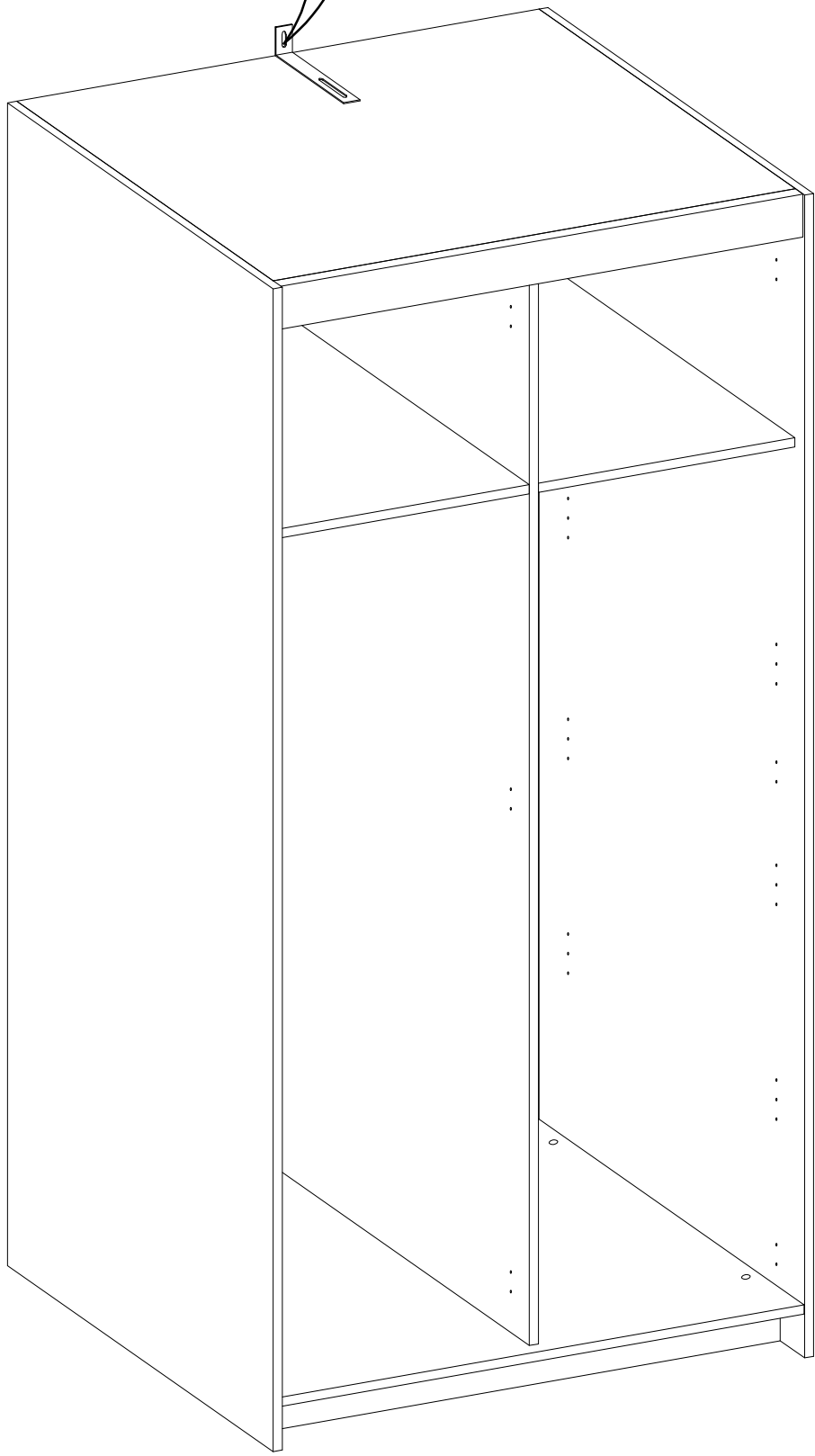
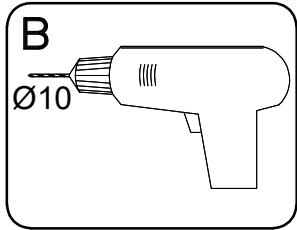
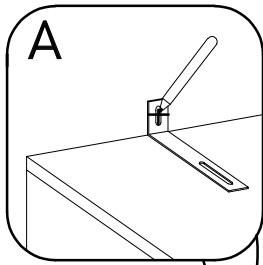
5

↑5.0x60mm	↑10x50mm	↑3.5x13mm	
			
P12	O7	P5	L19
1	1	2	1

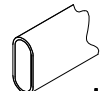

 J3 12	 E 20	 J2 1	 J17 2	 P5 2
---	--	--	---	--

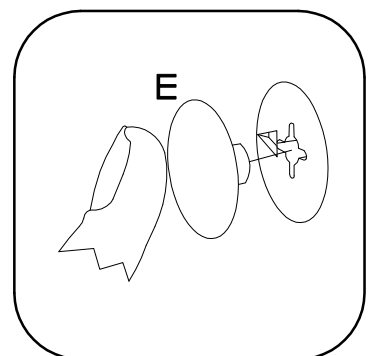
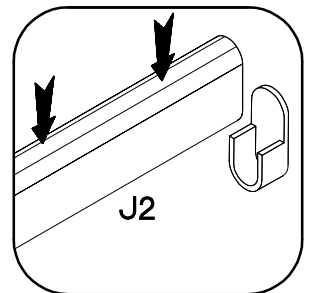
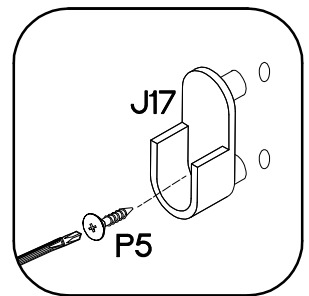
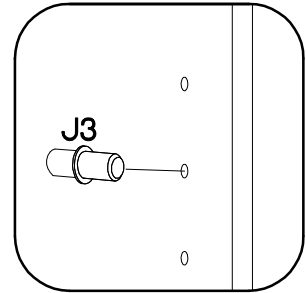
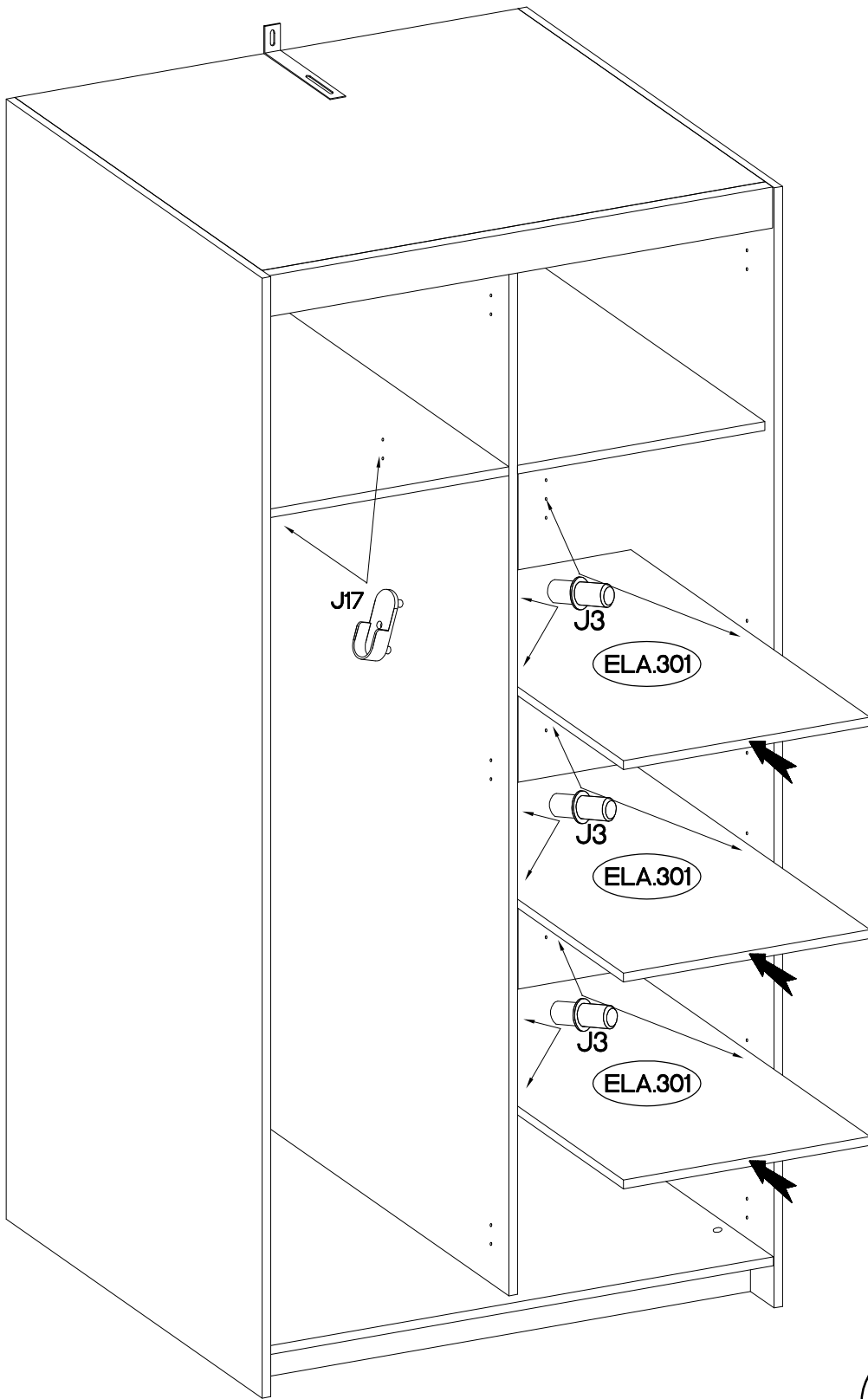

7

±35/16mm	H=0	±3.5x13mm
G2		P5
6	6	12

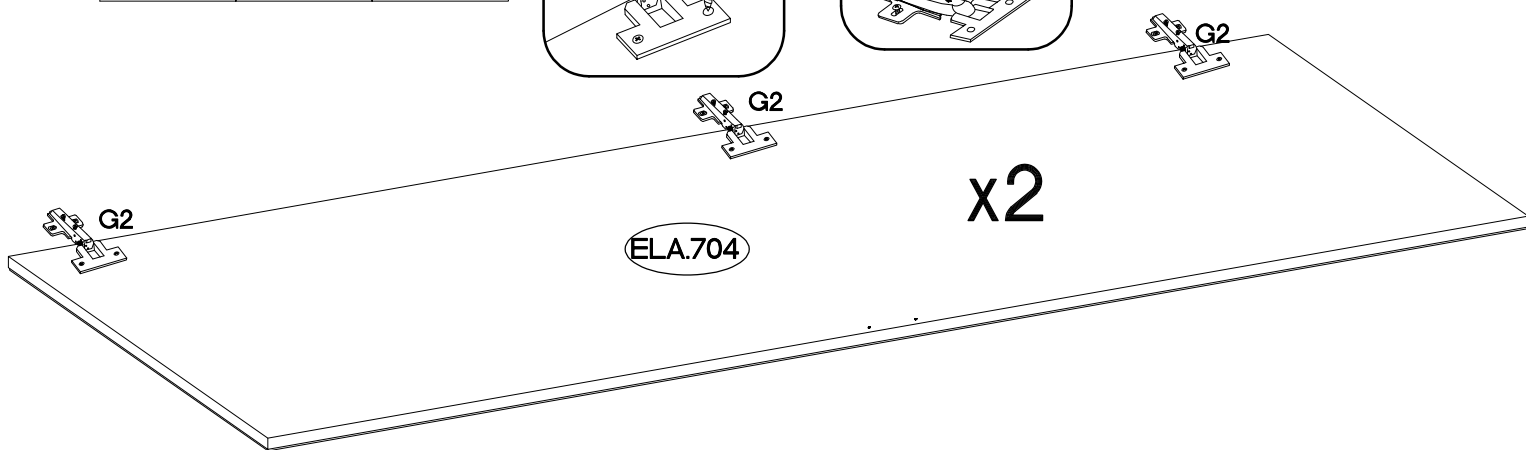
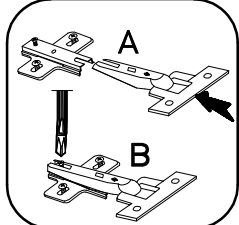
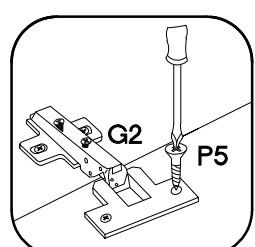

8

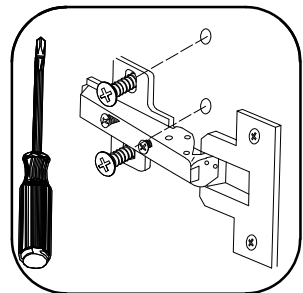

L=64mm
S
2

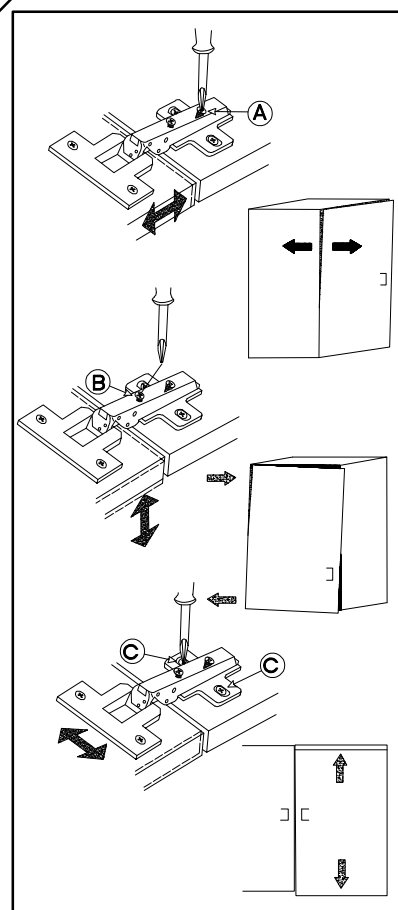
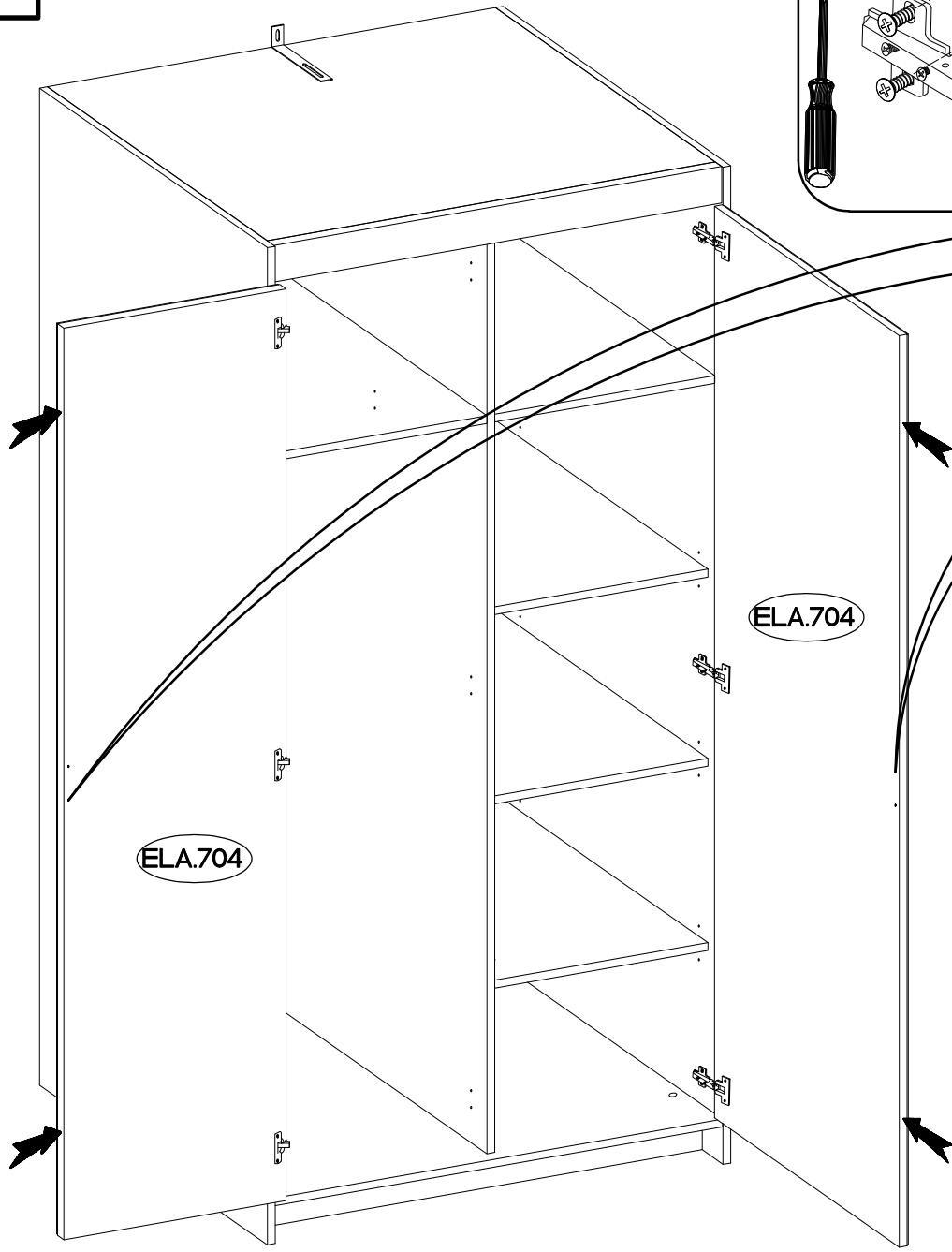
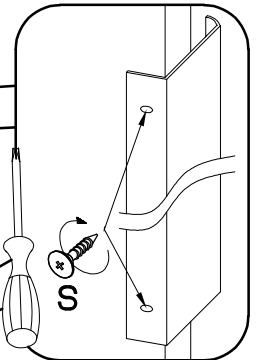

ELENA NA 2D

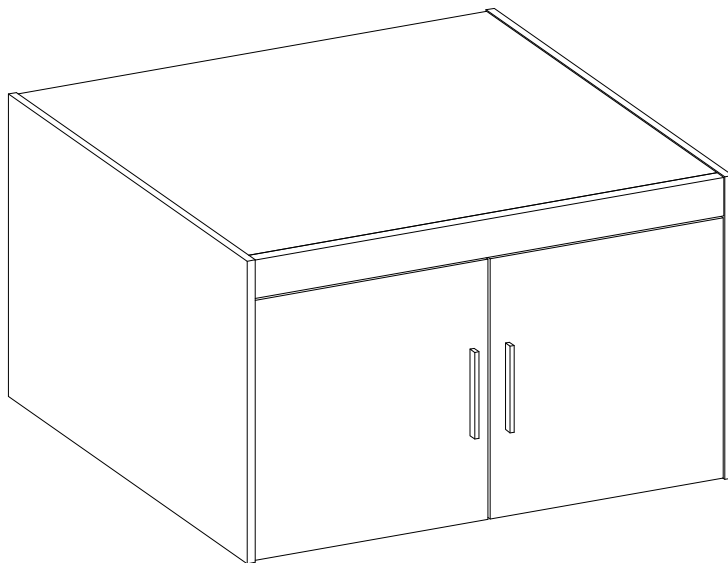
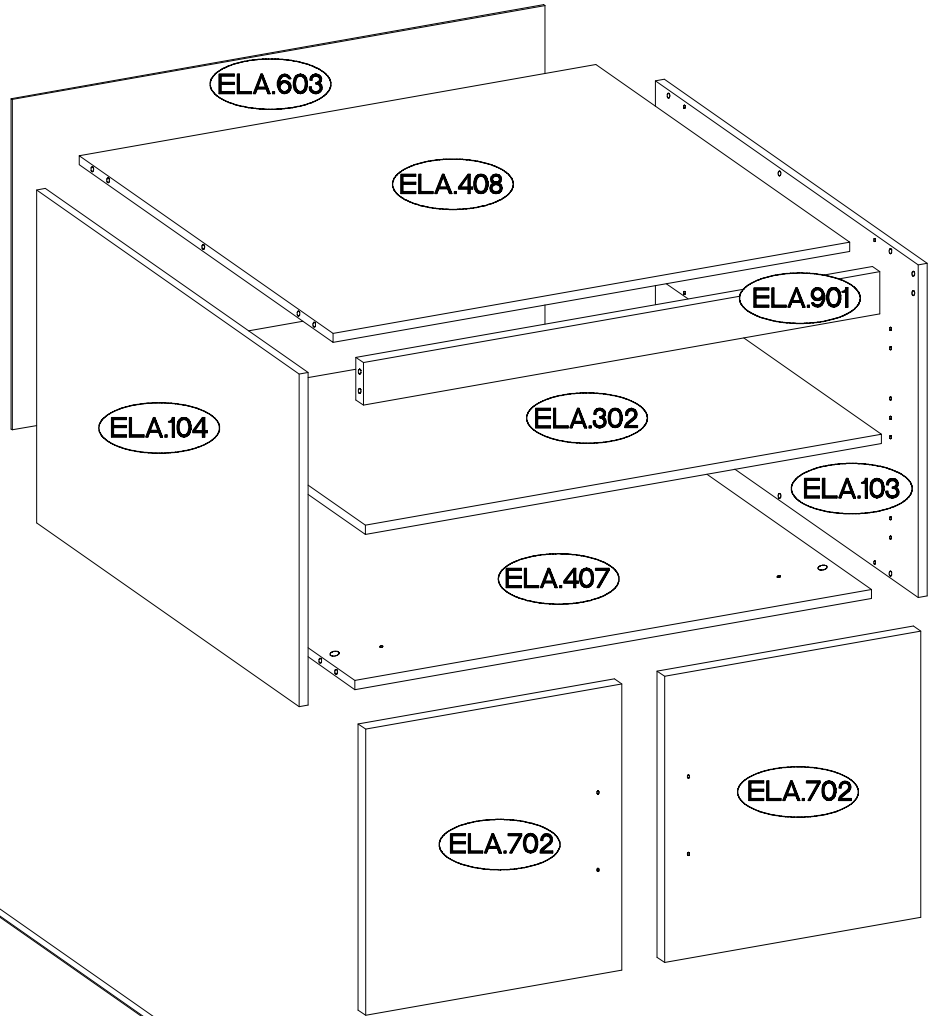
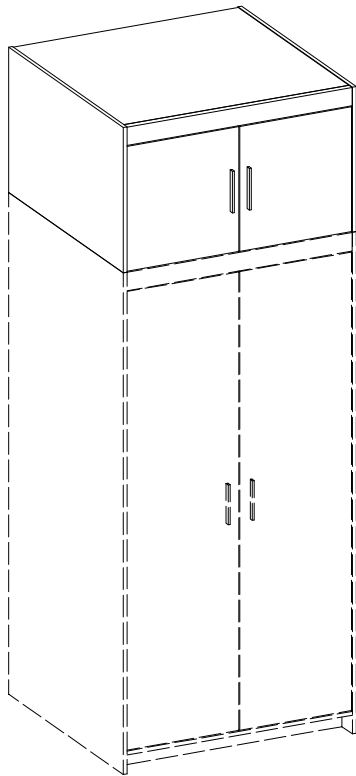
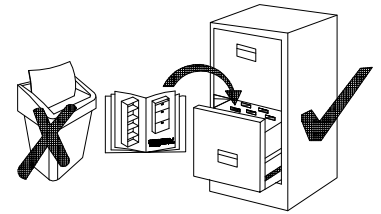
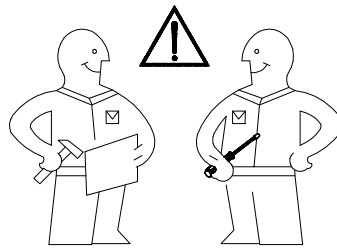
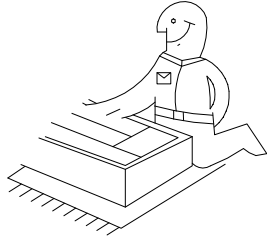
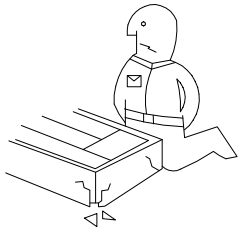



ELA.302 = max. 5kg

 R 4	 G2 4	 H 4	 P5 8
------------	-------------	------------	-------------

 S11 2	 R1 4	 P7 20	 J3 4	 C 8	 E 8	 A 16	 D2 8
--------------	-------------	--------------	-------------	------------	------------	-------------	-------------

ISM-ELA-04

1

Ø15/12mm 	Ø8x30mm 	L=20mm 
C 8	A 16	D2 8

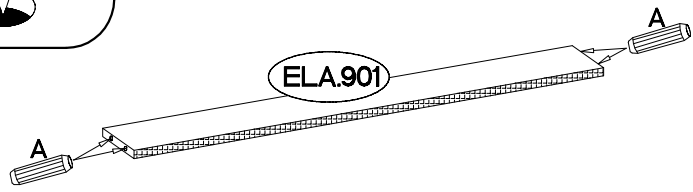
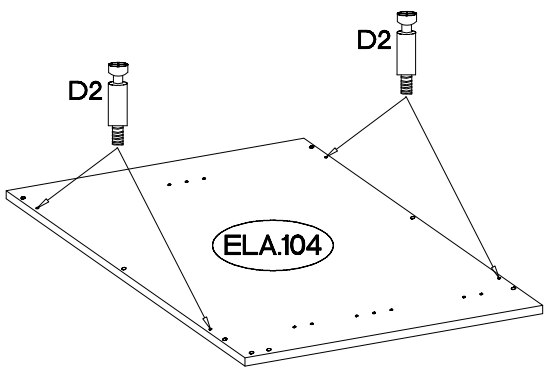
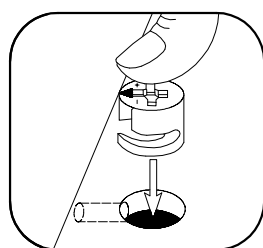
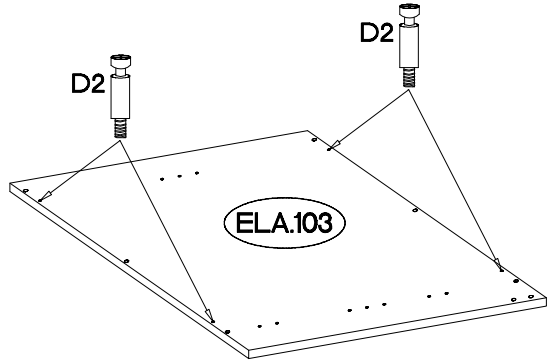
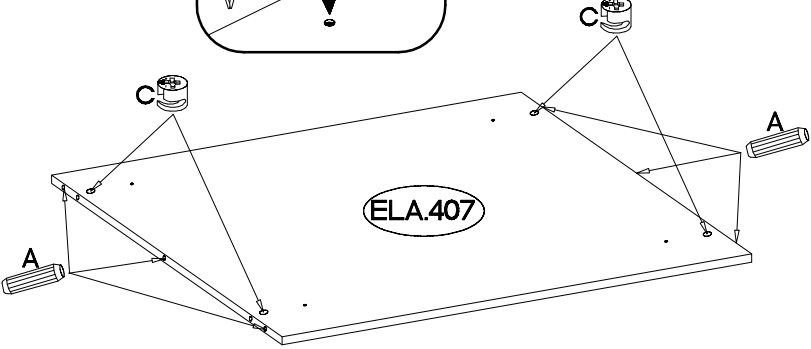
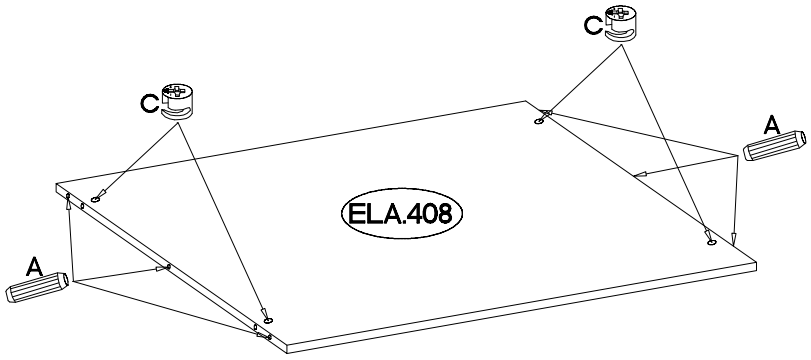
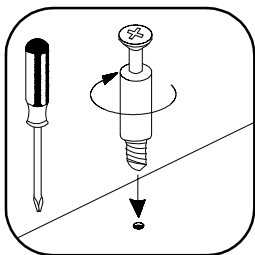

2

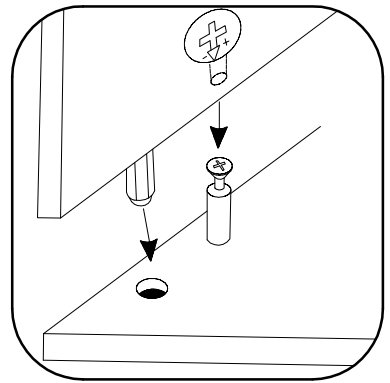
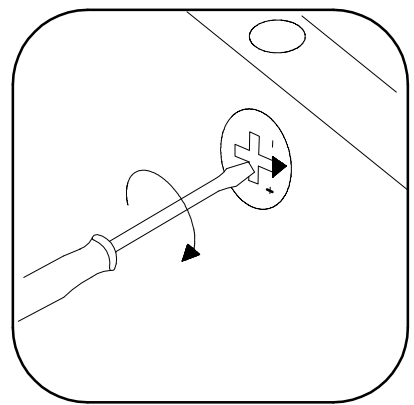
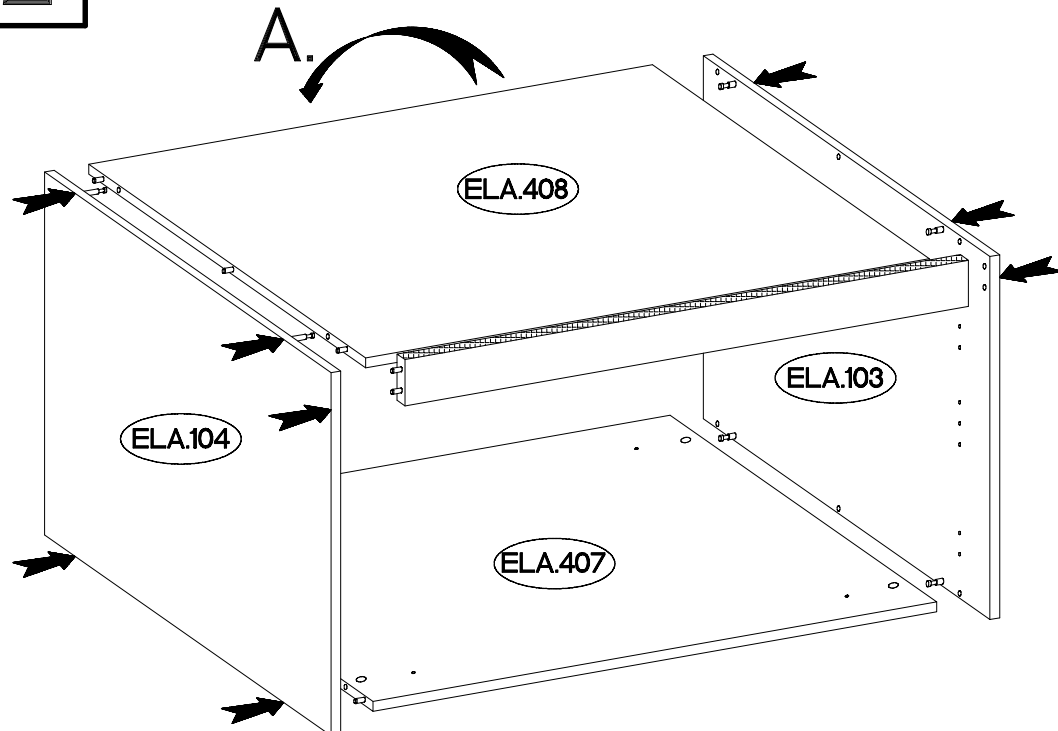

3

±3.0x20mm



P7

20

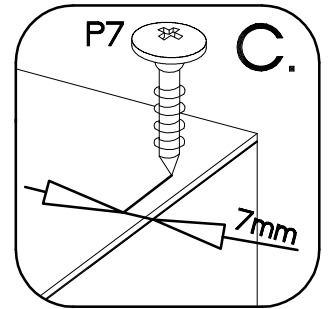
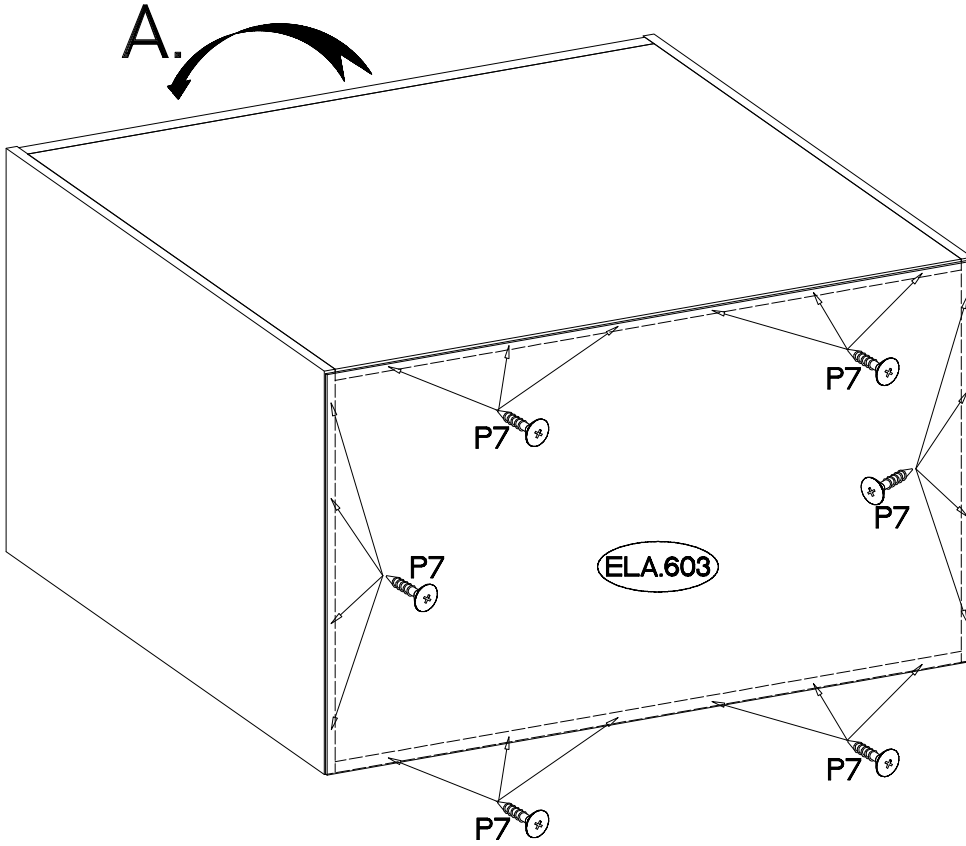
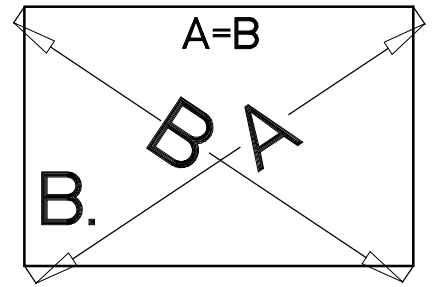

4

±35/16mm



G2

4

H=0



H

4

±3.5x13mm



P5

8

L=128mm

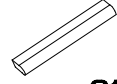

S11

2

±4.0x27mm



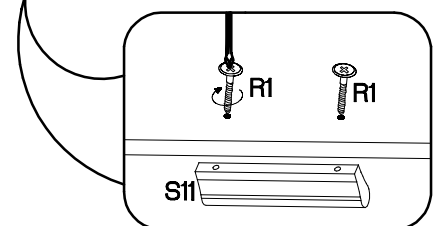
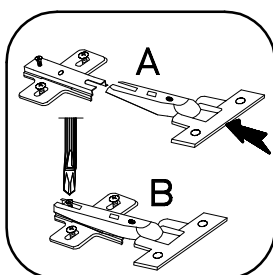
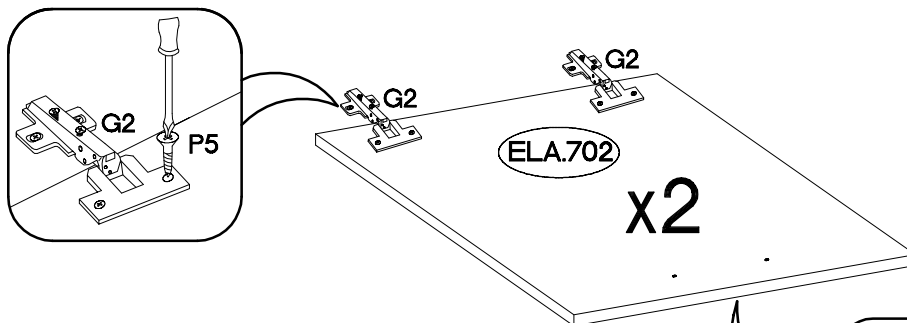

R1

4



5

	
J3	E
4	8

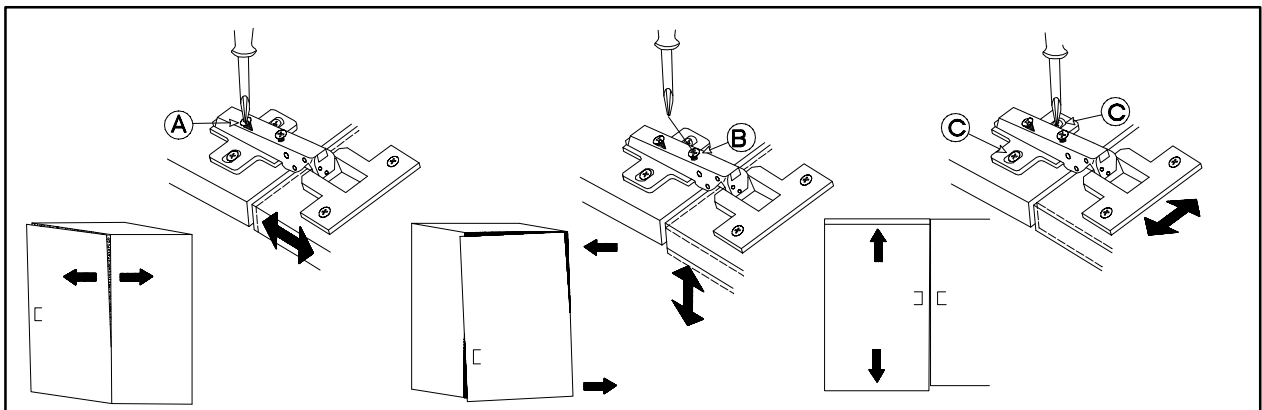
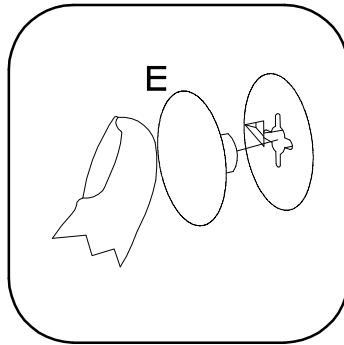
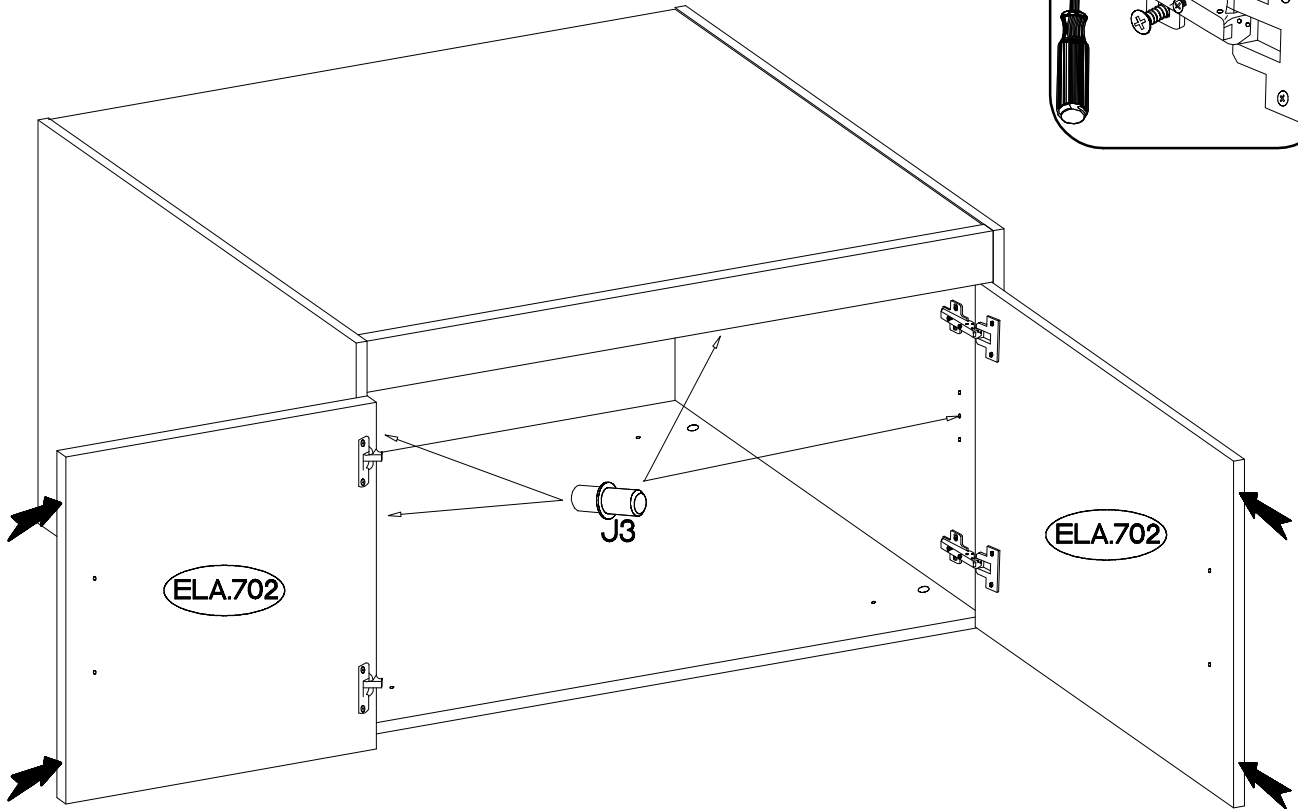
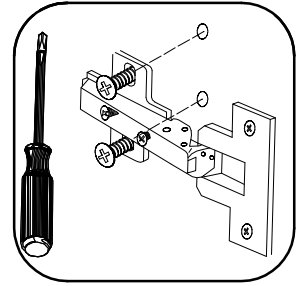

6

±4.0x25mm



R

4

