

120 min

ELENA 2D-1L

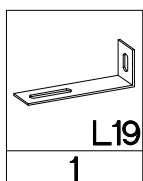
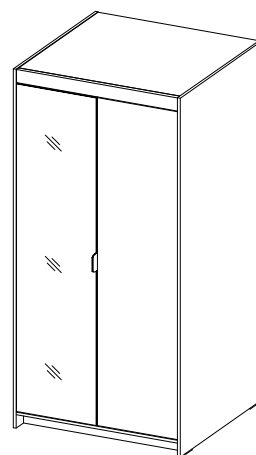
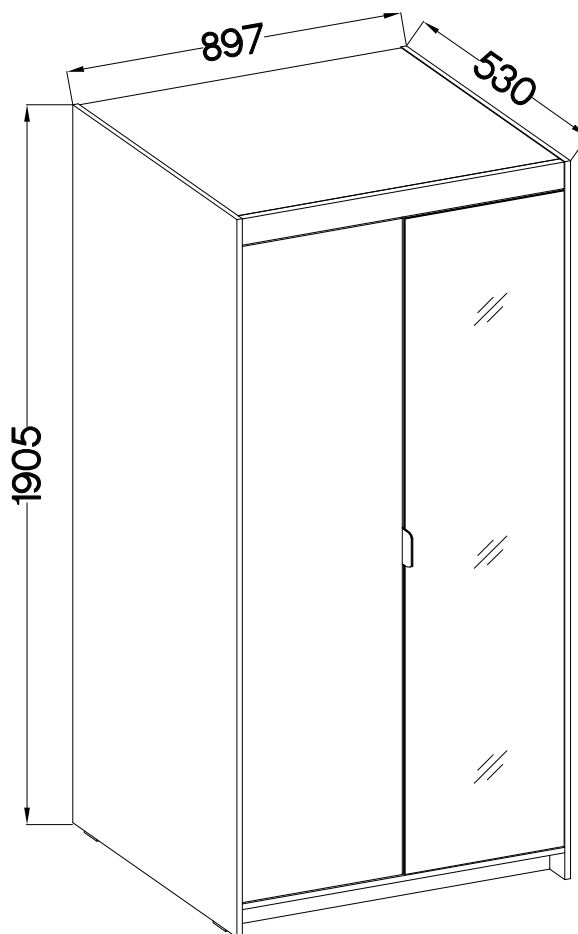
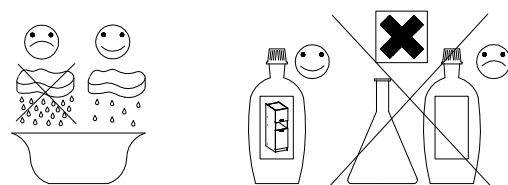

L19

1

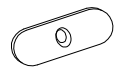

L2

14



G2

6



C

20

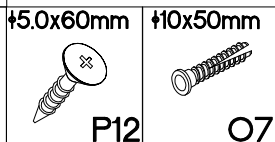

P12

1

O7

1

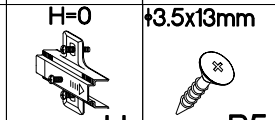

H

6

P5

16

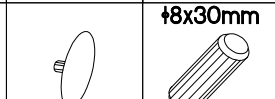

E

20

A

42

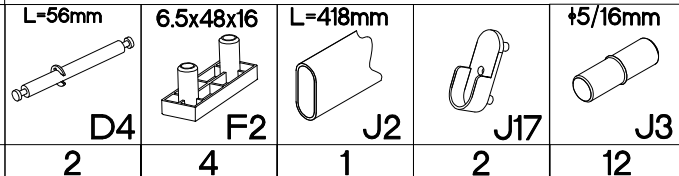

D4

2

F2

4

J2

1

J17

2

J3

12

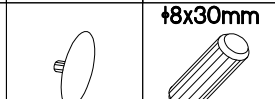

D2

16

S

2

P7

57

F4

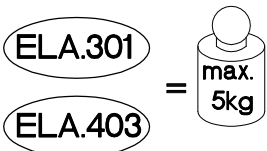
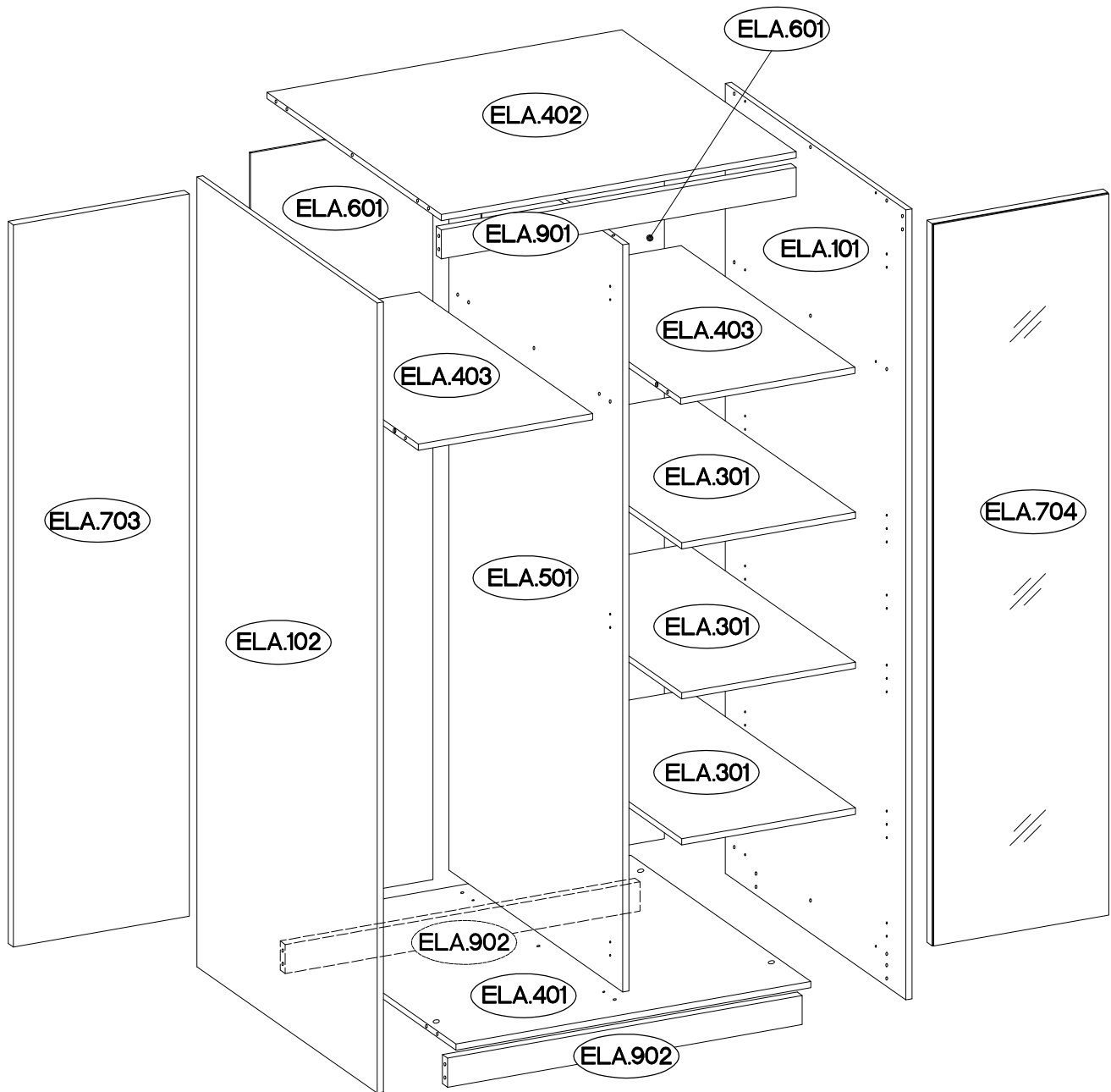

2

P-ISM-ELA-19

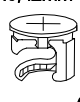
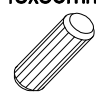

Colli	Ersatzteil Nummer	Dimension
Colli 1/2	ELA.102	1900x530x15
	ELA.301 x3	425x495x15
	ELA.401	867x529x15
	ELA.402	867x512x15
	ELA.403 x2	426x510x15
	ELA.901	867x70x15
	ELA.902 x2	867x70x15

Colli	Ersatzteil Nummer	Dimension
Colli 2/2	ELA.101	1900x530x15
	ELA.501	1797x511x15
	ELA.601 x2	1825x446x2,5
	ELA.703	1737x430x15
	ELA.704	1737x430x18

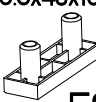
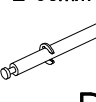
 <p>‡15/12mm <b>C</b></p>	 <p>‡8x30mm <b>A</b></p>	 <p>L=20mm <b>D2</b></p>	 <p>‡15x5mm <b>F4</b></p>	 <p>6.5x48x16 <b>F2</b></p>	 <p>L=56mm <b>D4</b></p>
20	42	16	2	4	2

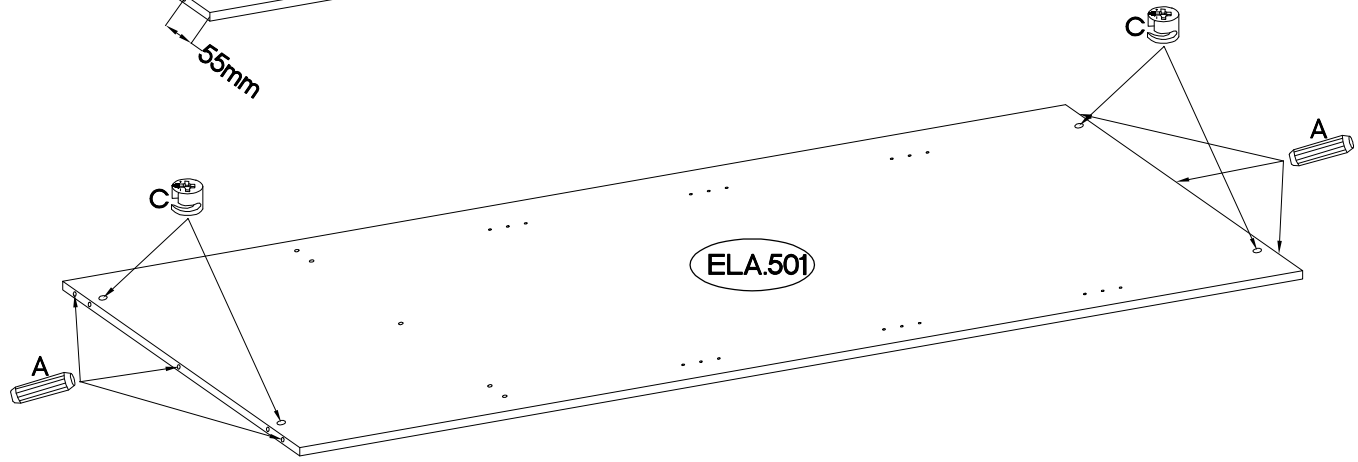
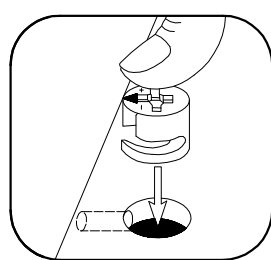
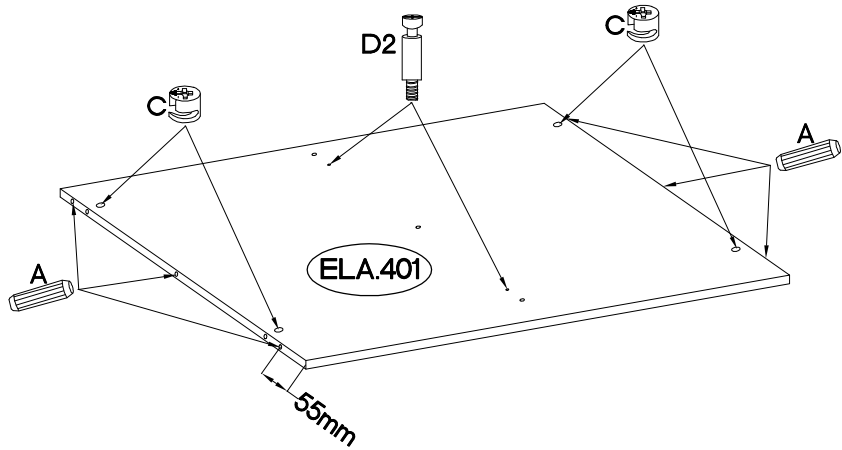
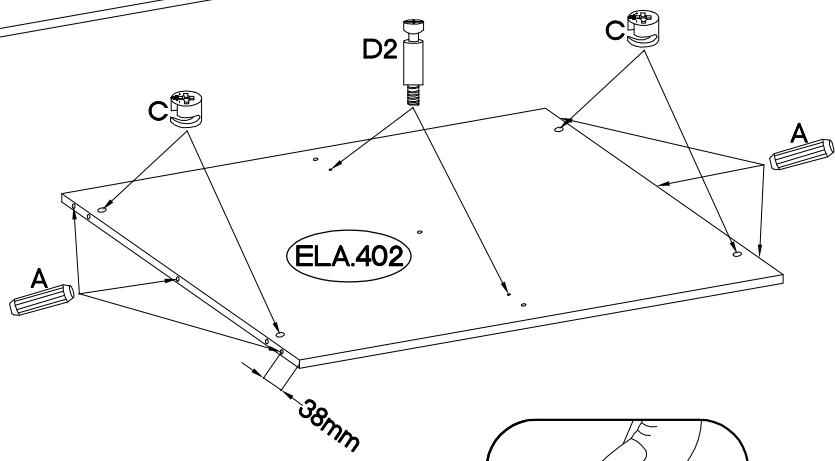
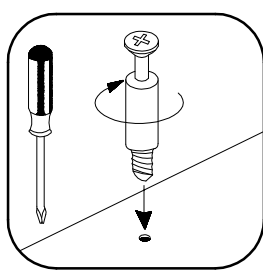
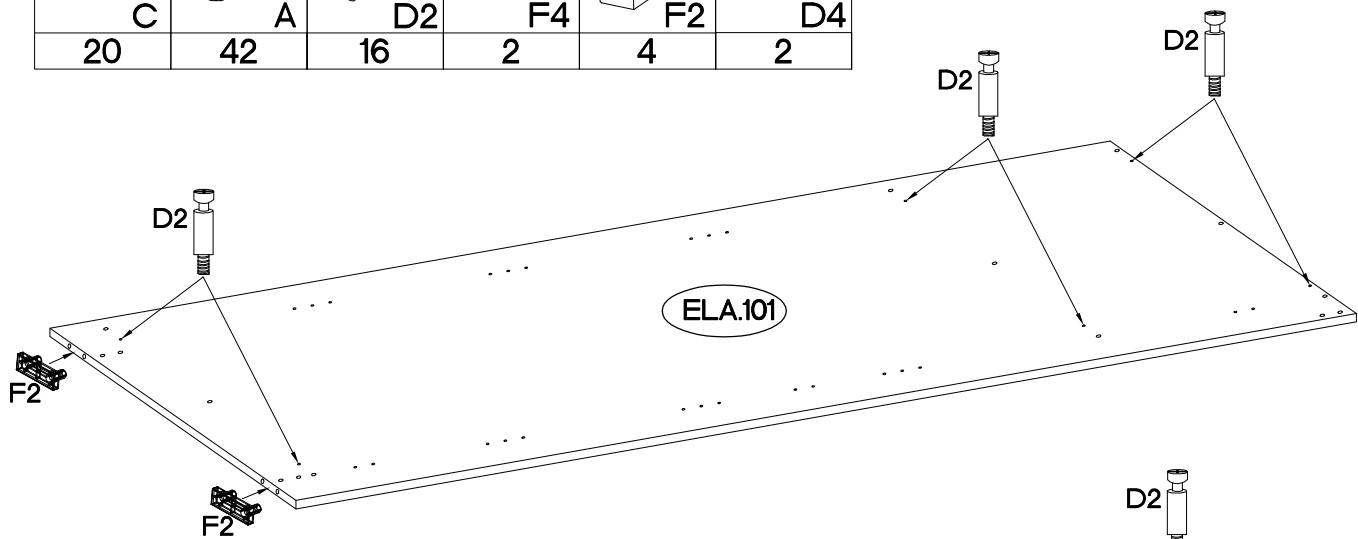

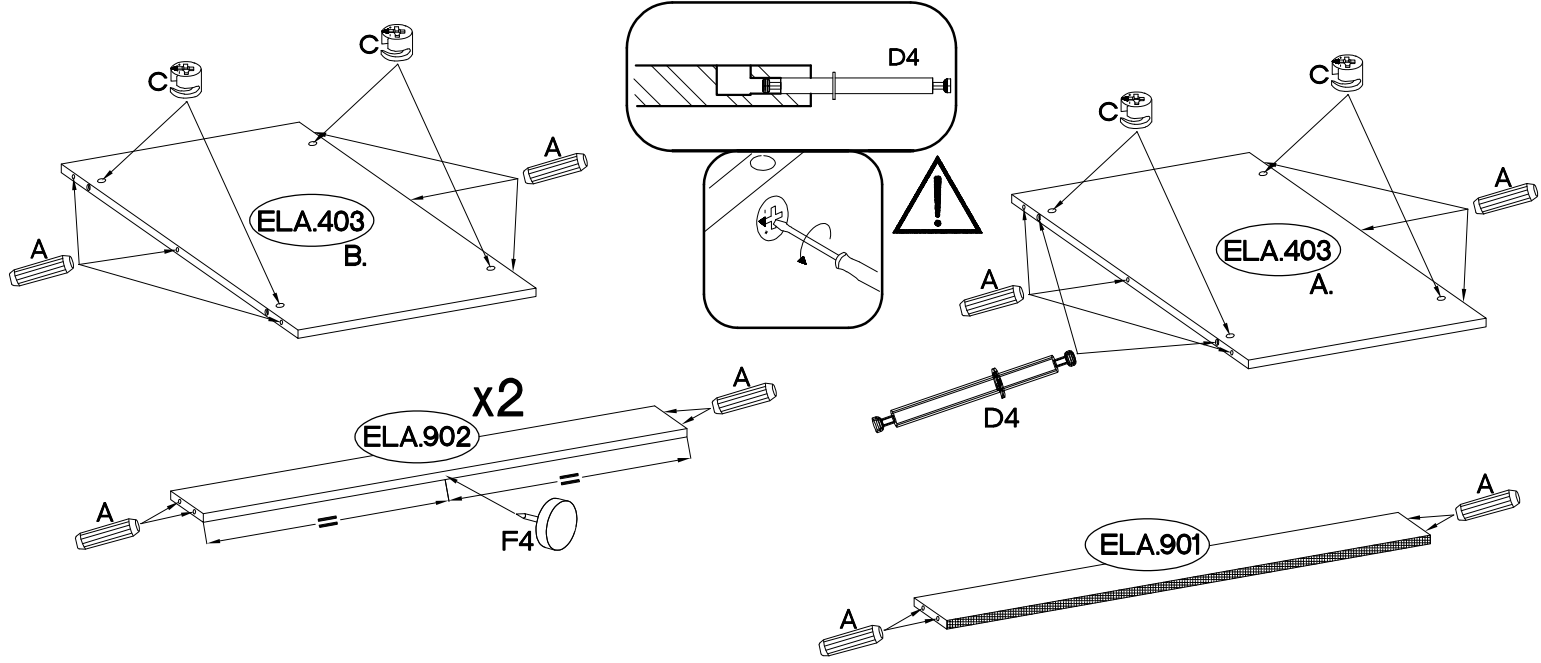

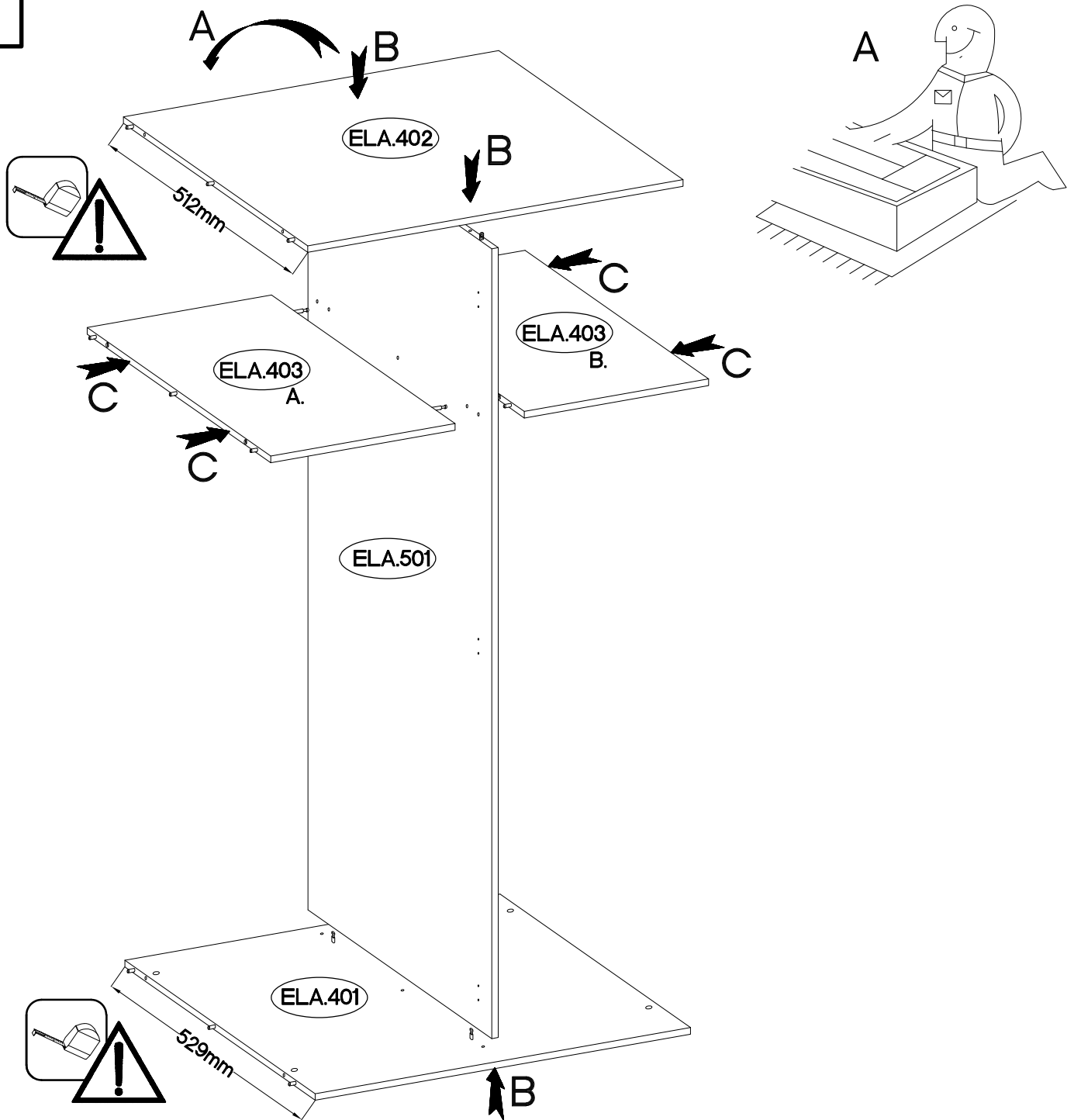

2

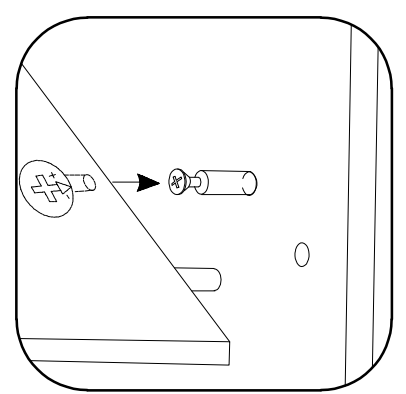
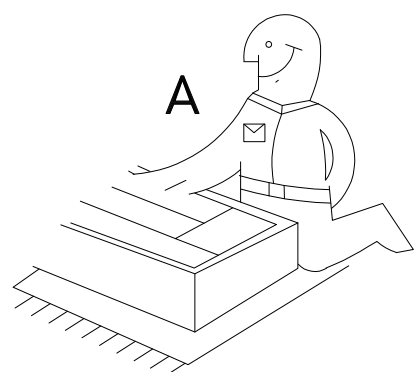
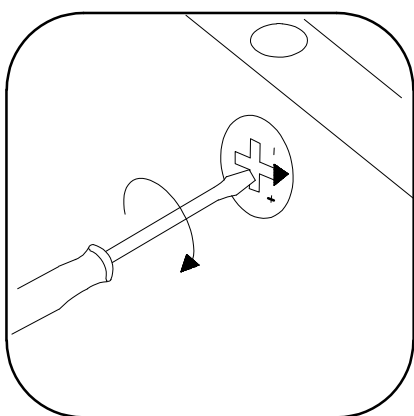
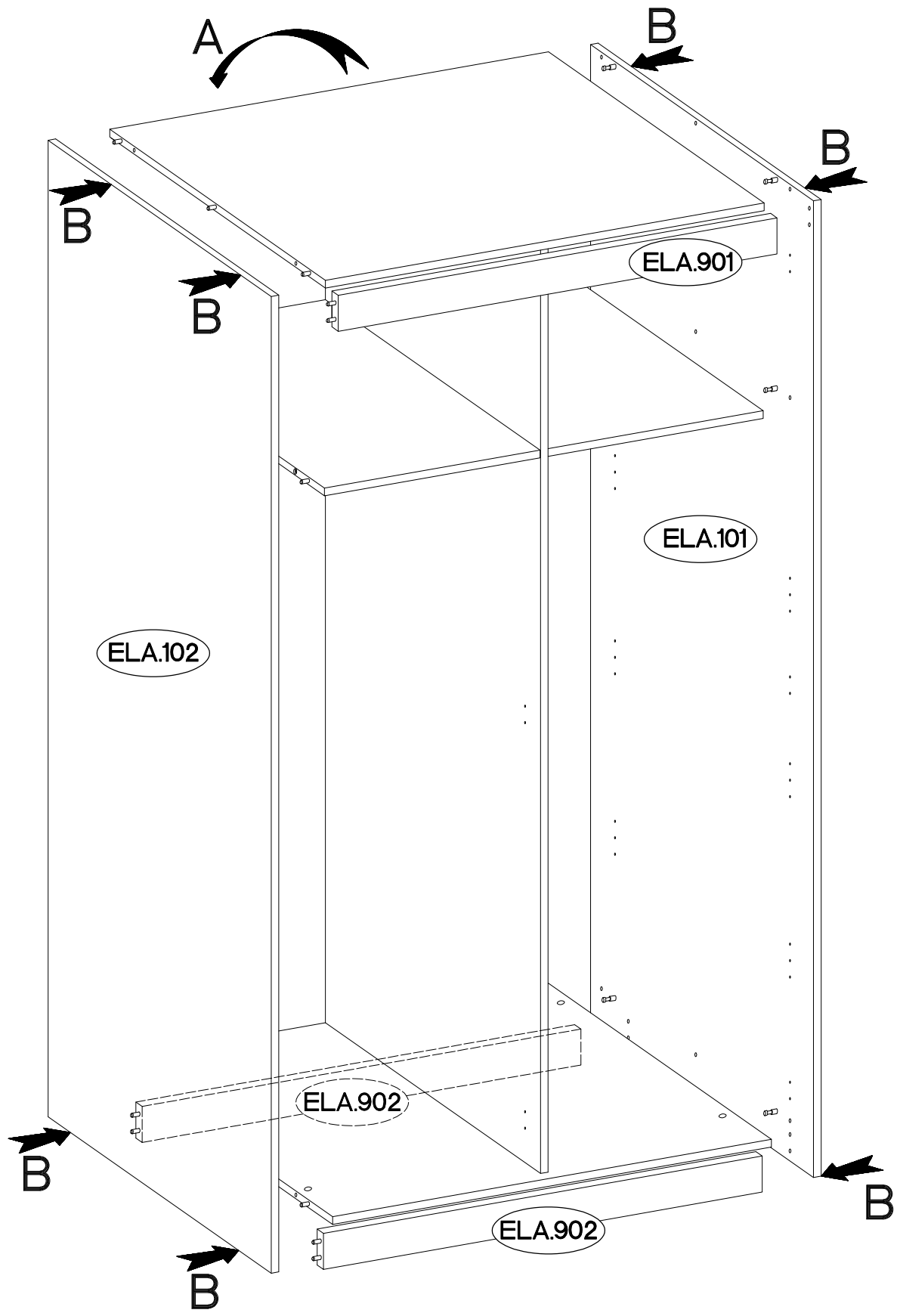

3

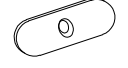



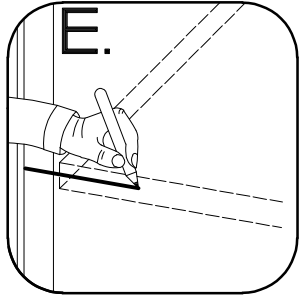
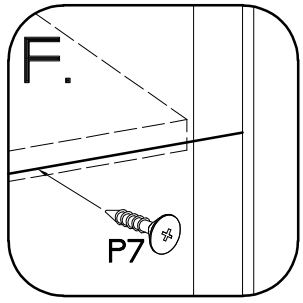
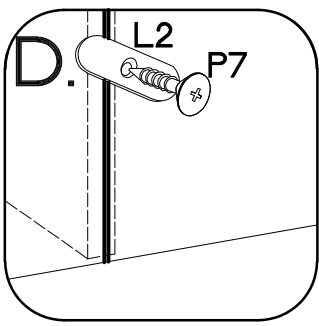
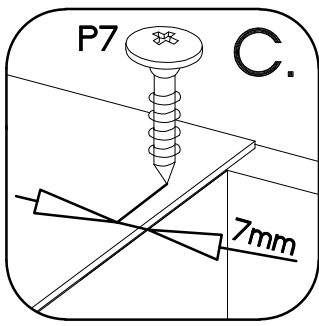
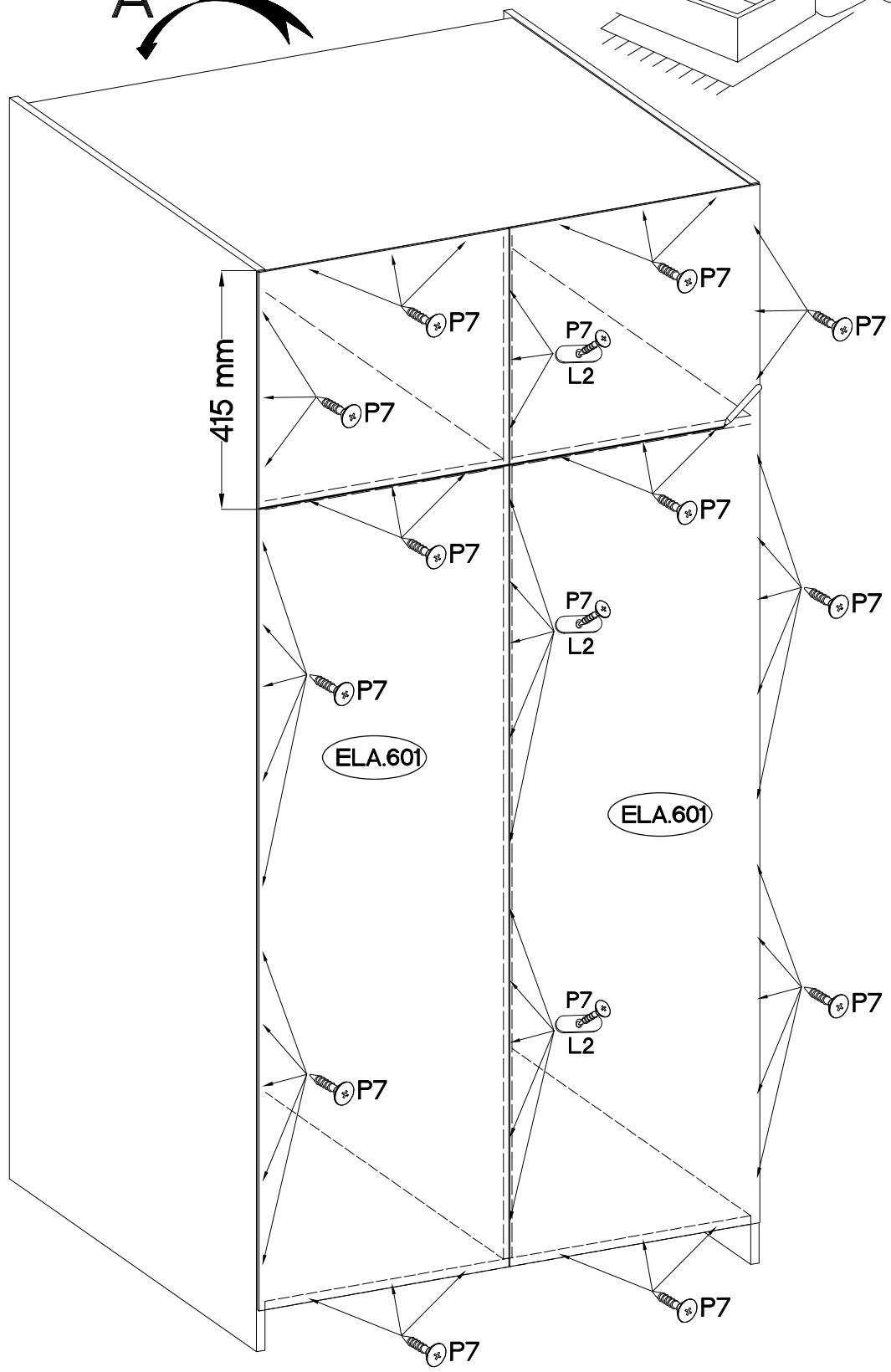
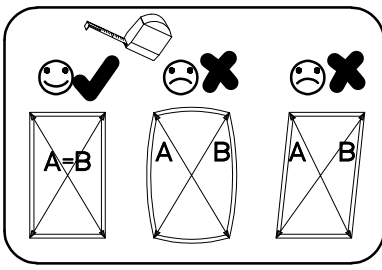
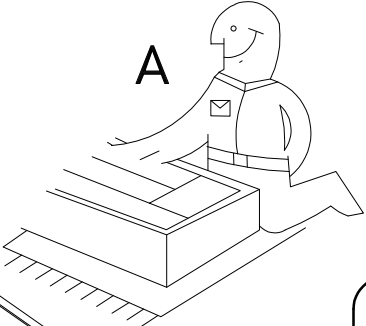



	#3.0x20mm 
L2	P7
14	57

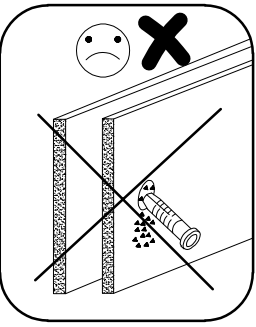
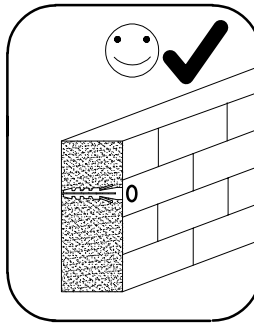
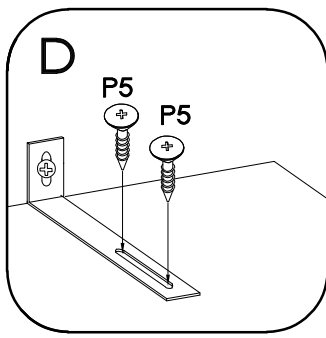
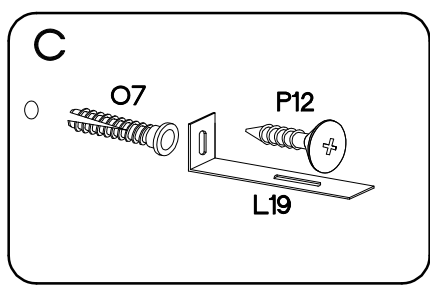
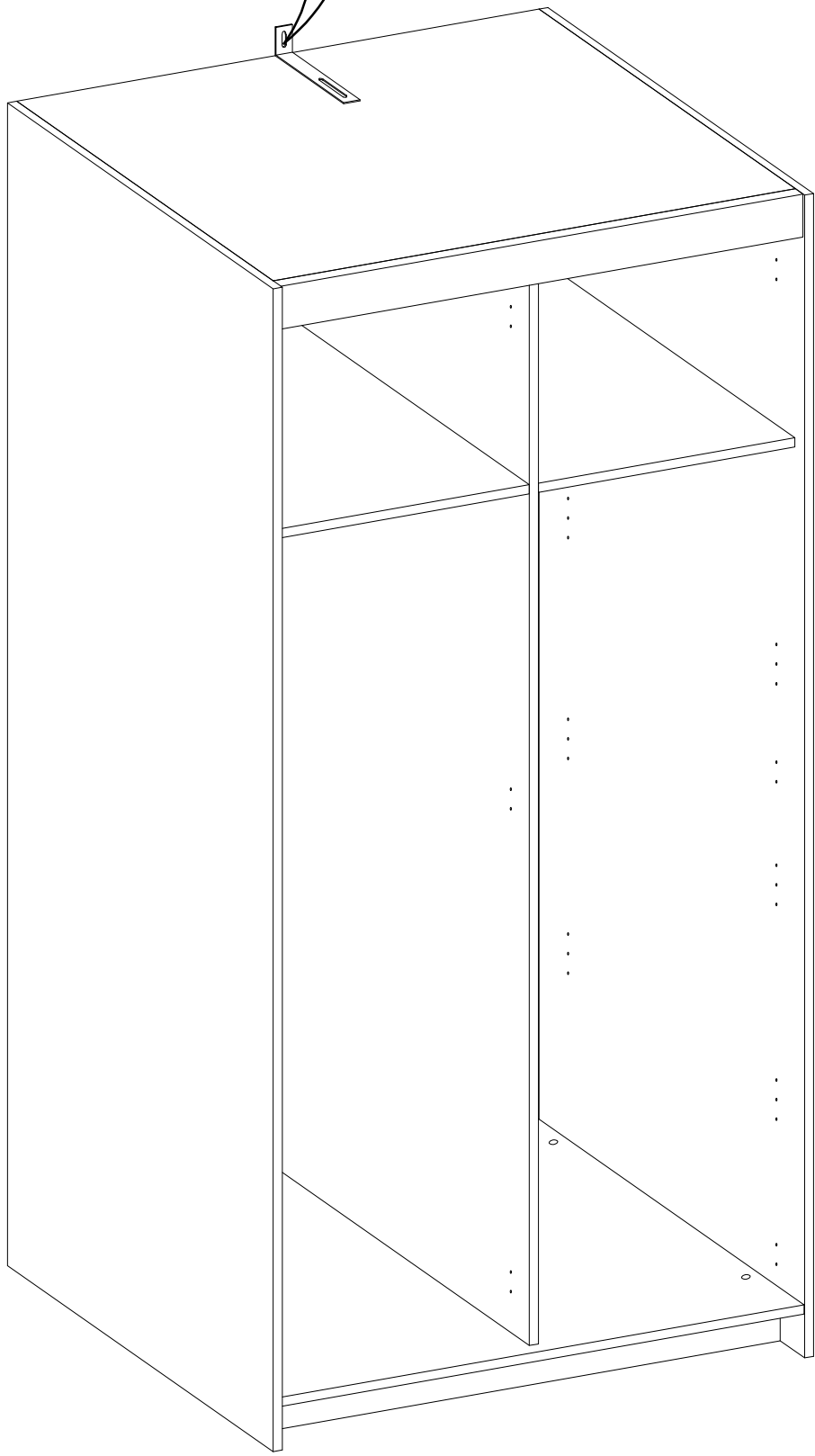
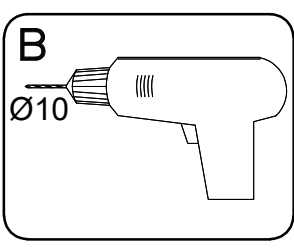
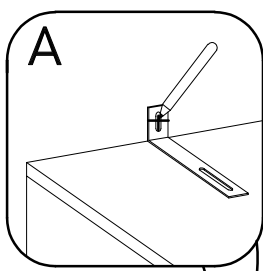

5



↑5.0x60mm	↑10x50mm	↑3.5x13mm	
P12	O7	P5	L19
1	1	2	1

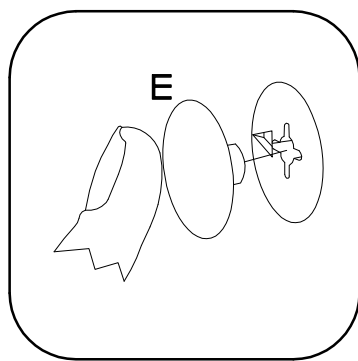
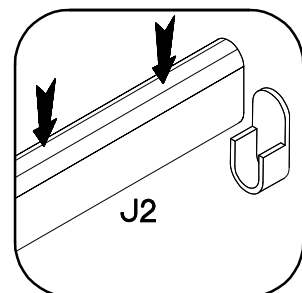
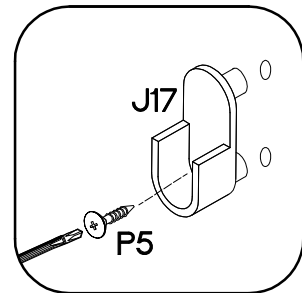
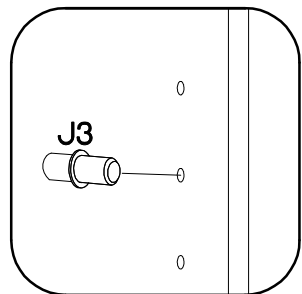
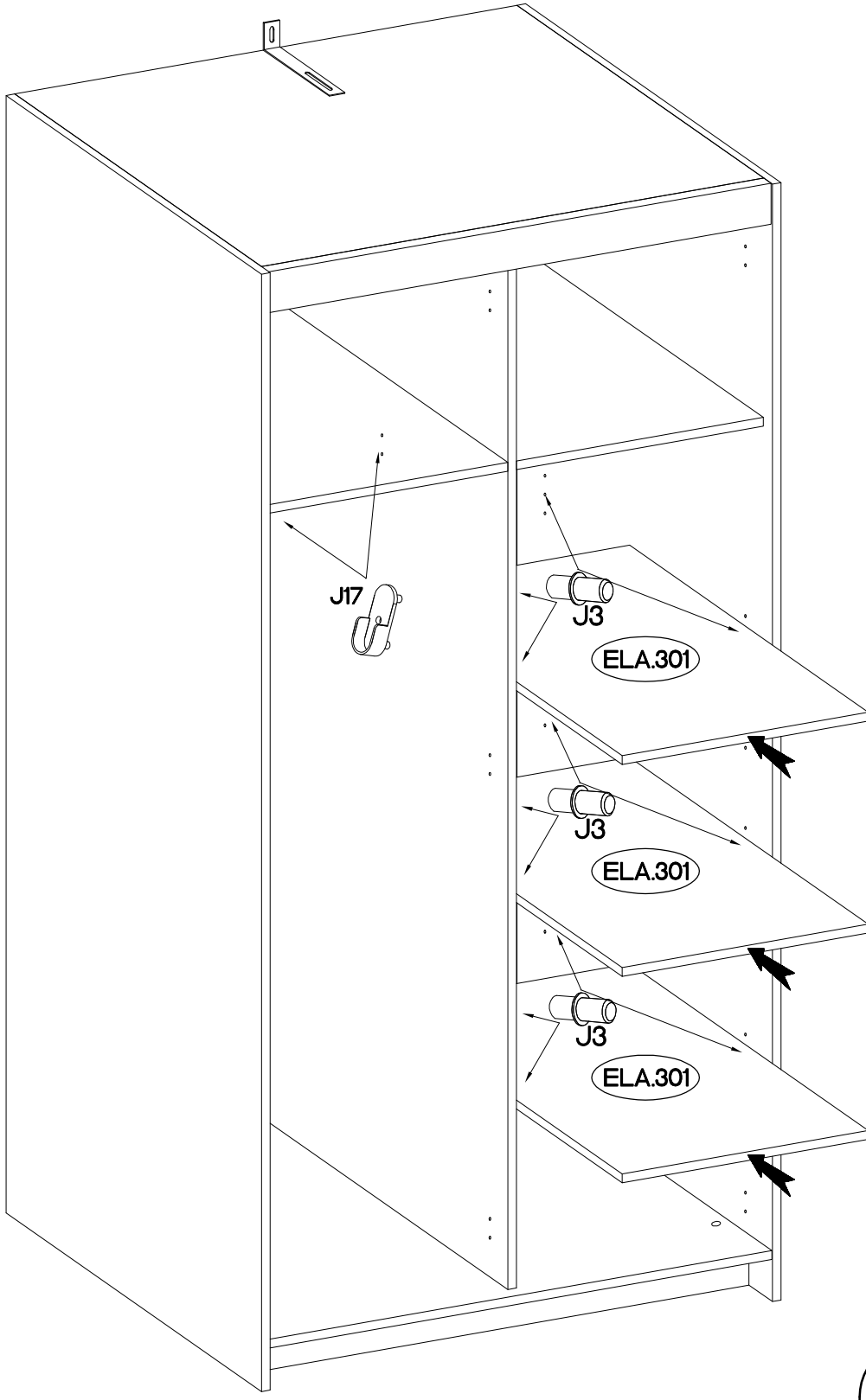

 <b>J3</b> 12	 <b>E</b> 20	 <b>J2</b> 1	 <b>J17</b> 2	 <b>P5</b> 2
---	--	--	---	--

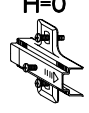

7

±35/16mm	H=0	±3.5x13mm
		
G2		P5
6	6	12

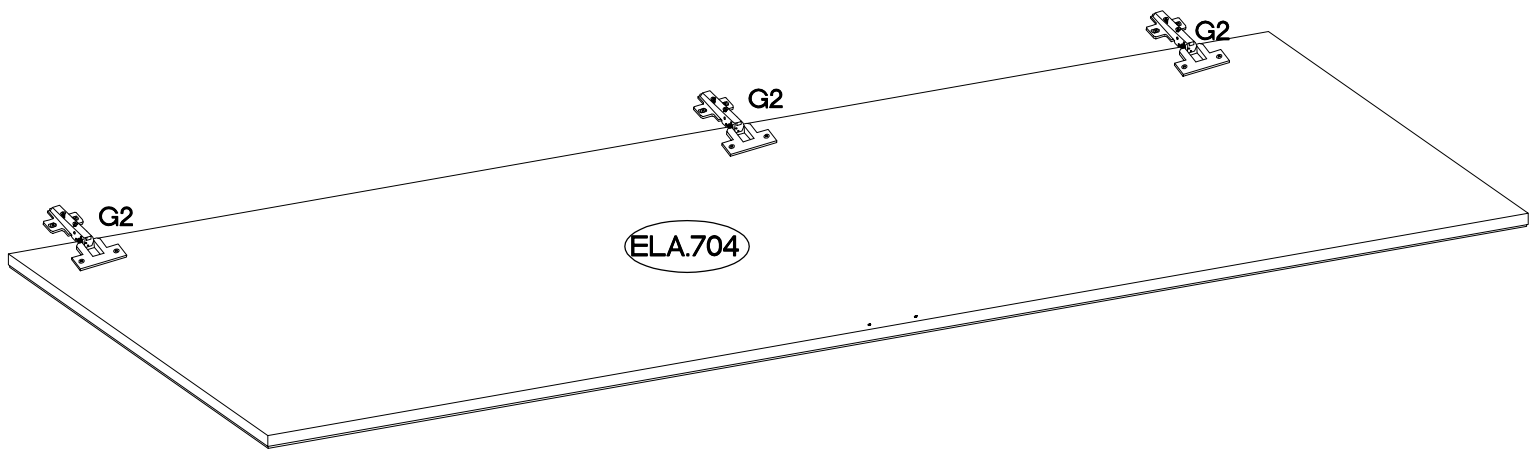
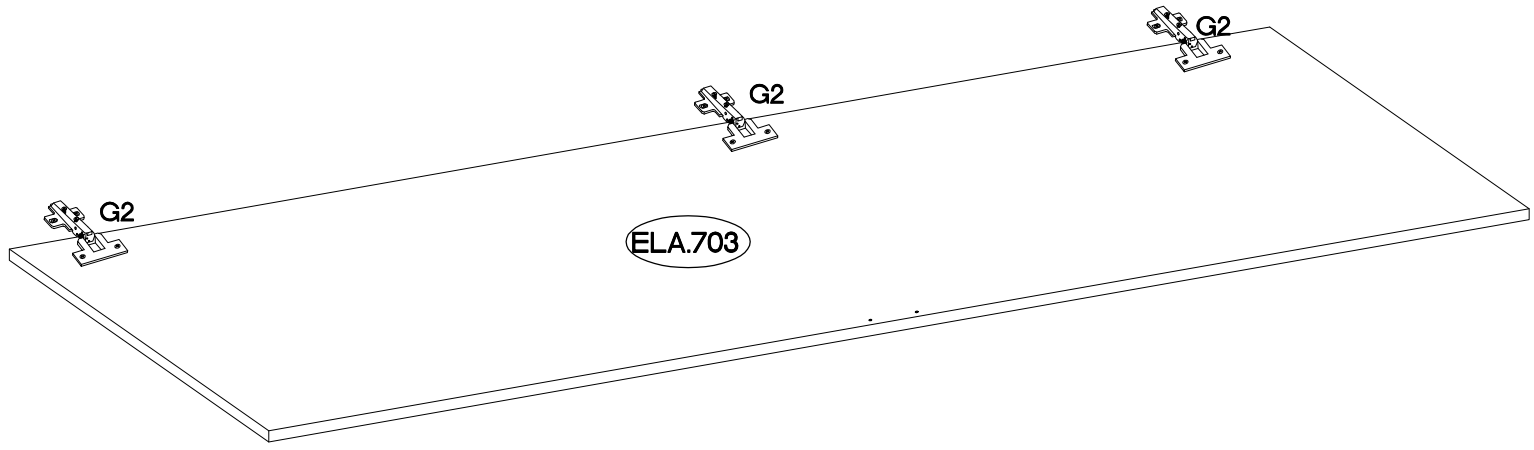
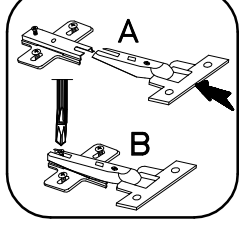
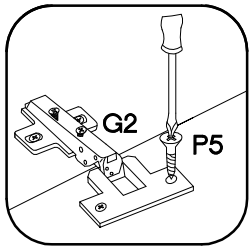

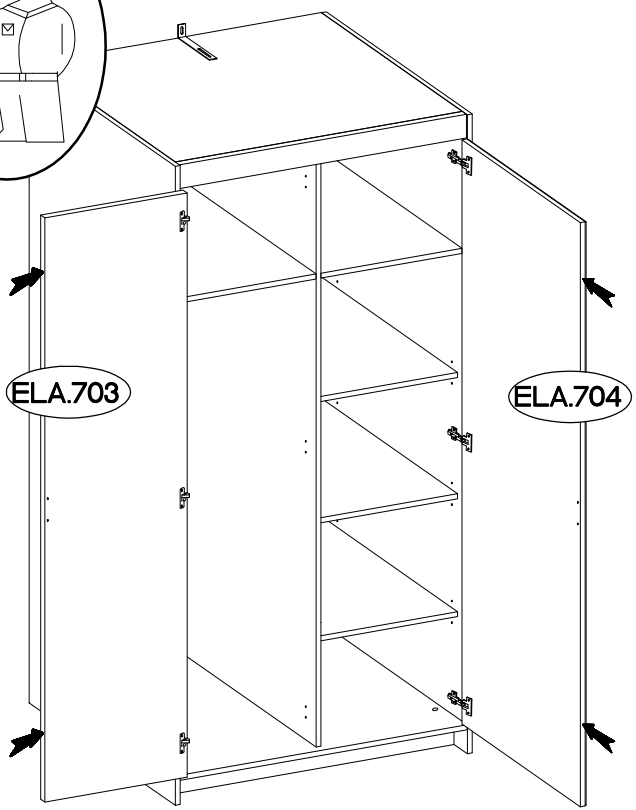
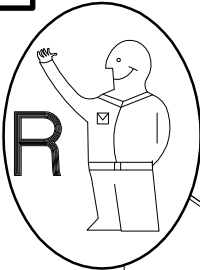

L=64mm  
S  
2

