

STEP 1

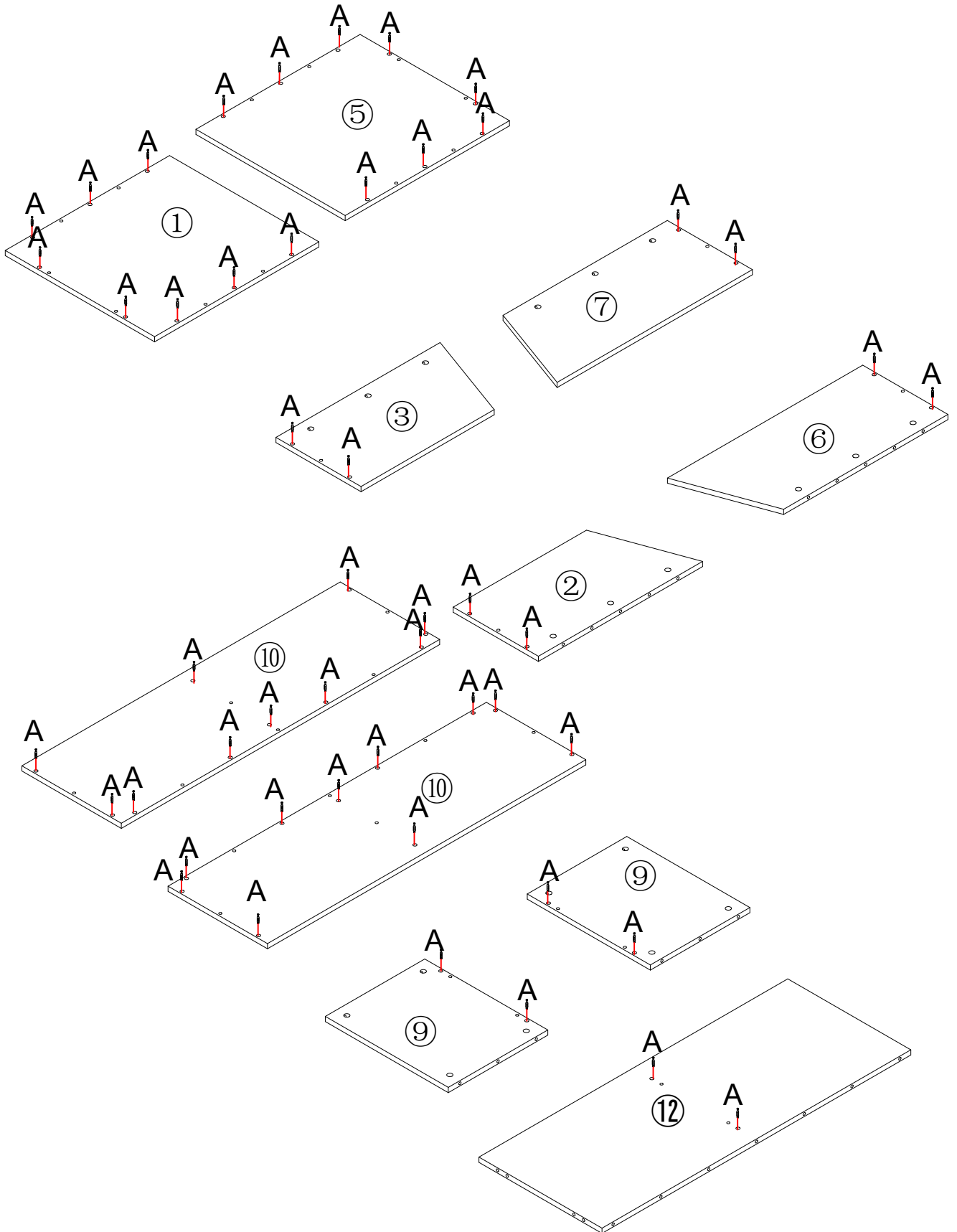

STEP 2

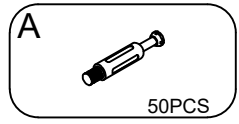
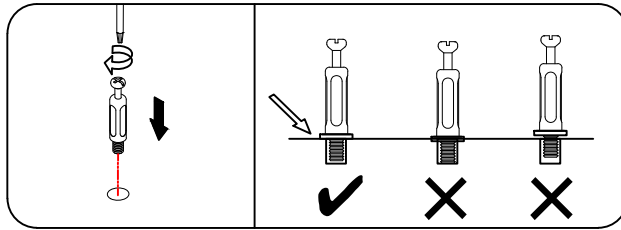
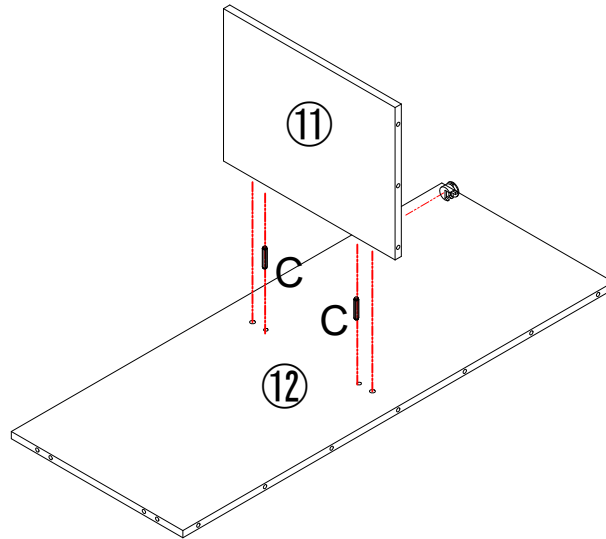
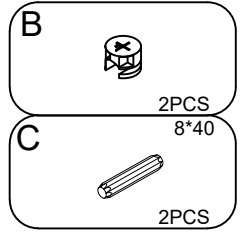
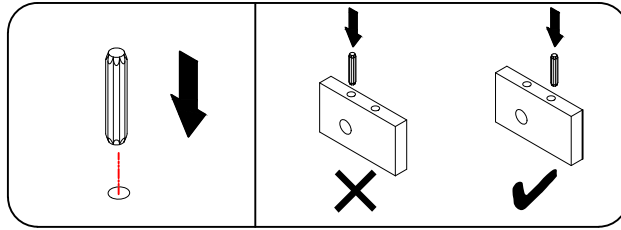
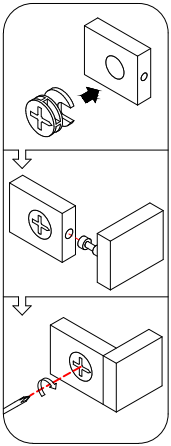

STEP 3

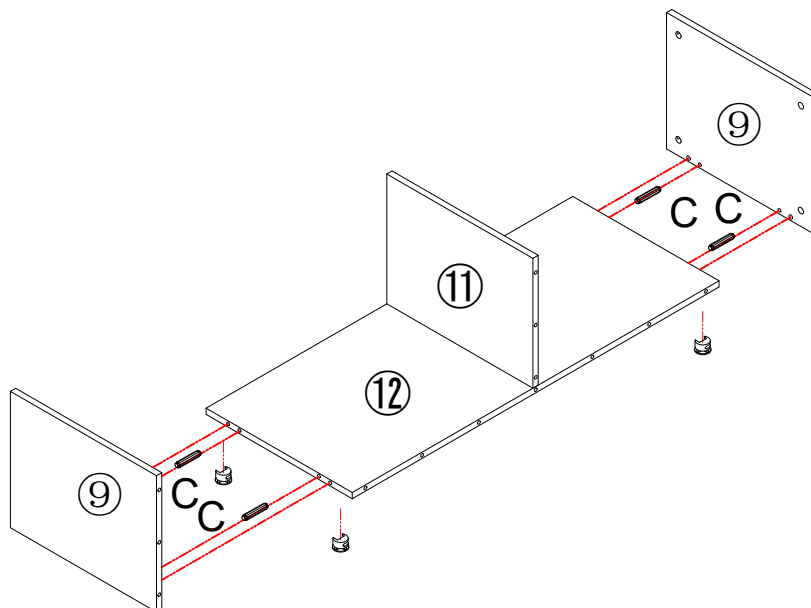
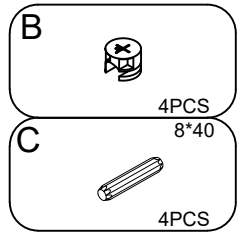
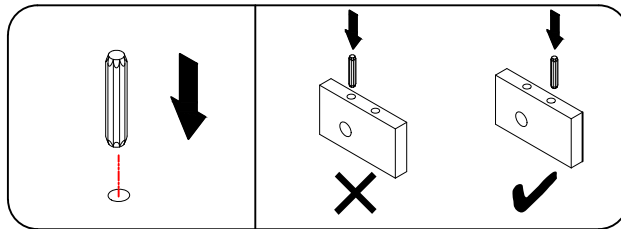
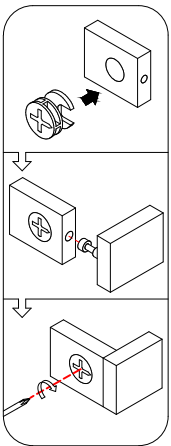

STEP 4

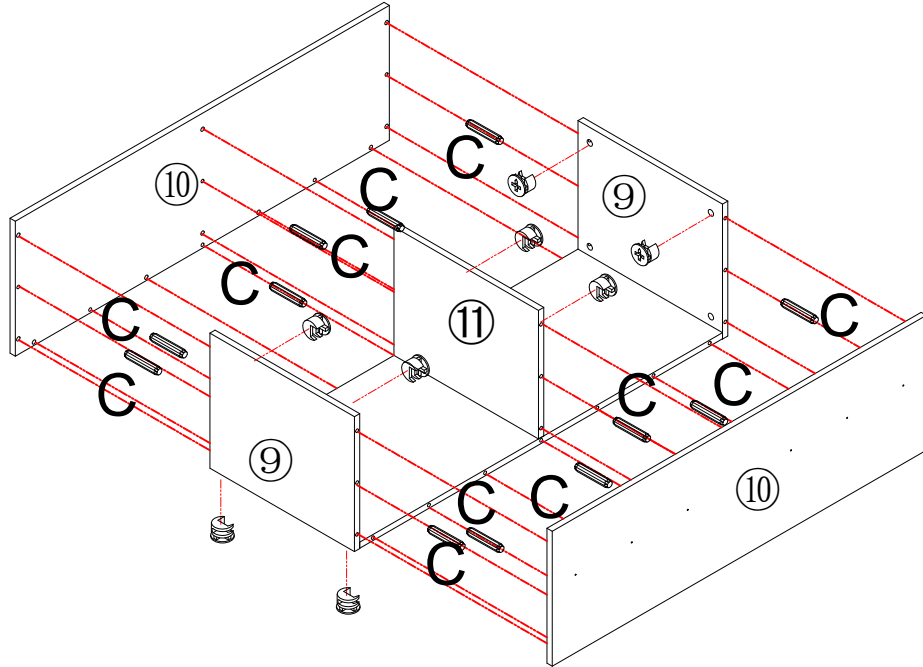
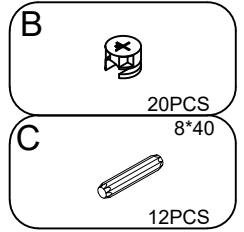
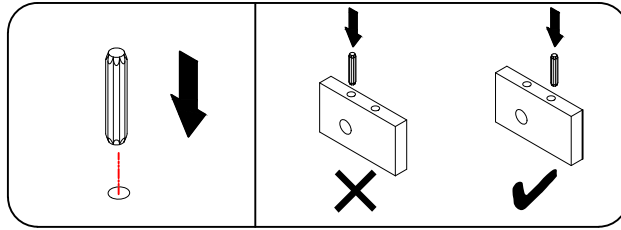
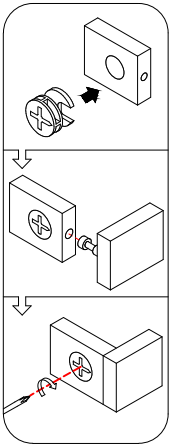

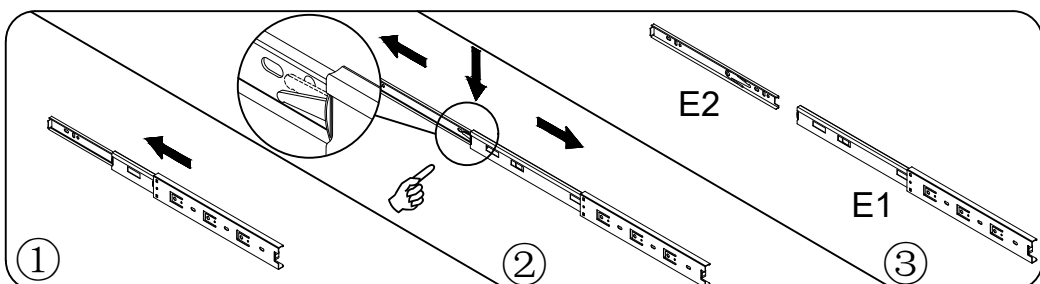
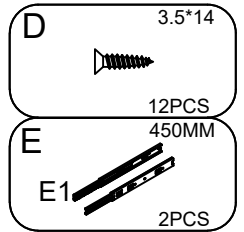
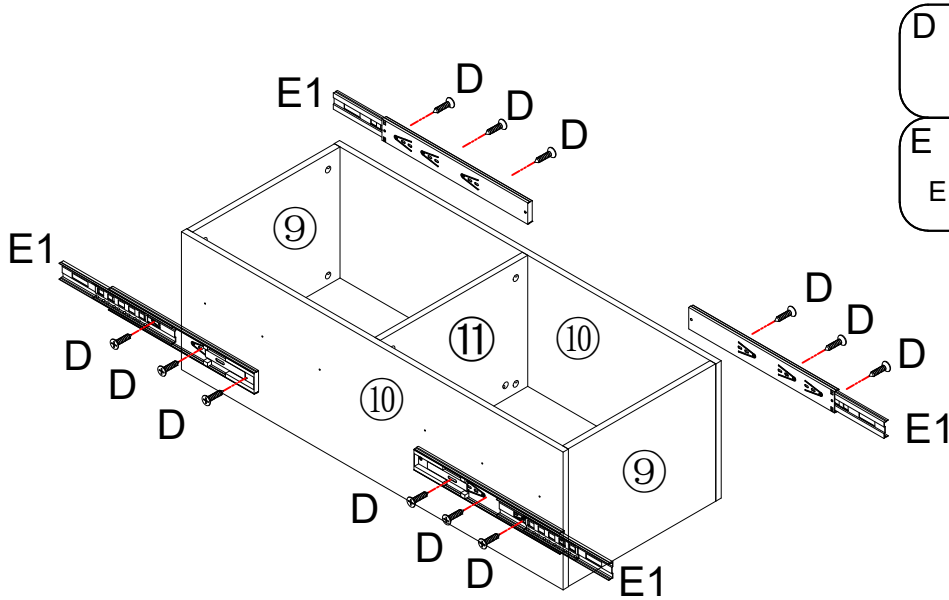

STEP 5

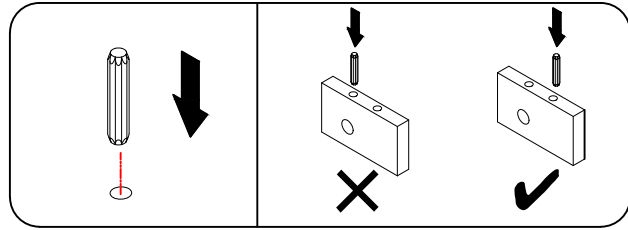
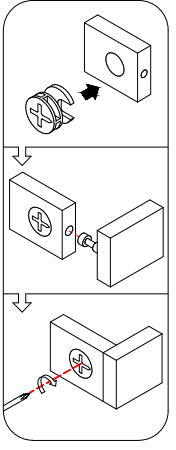

STEP 6



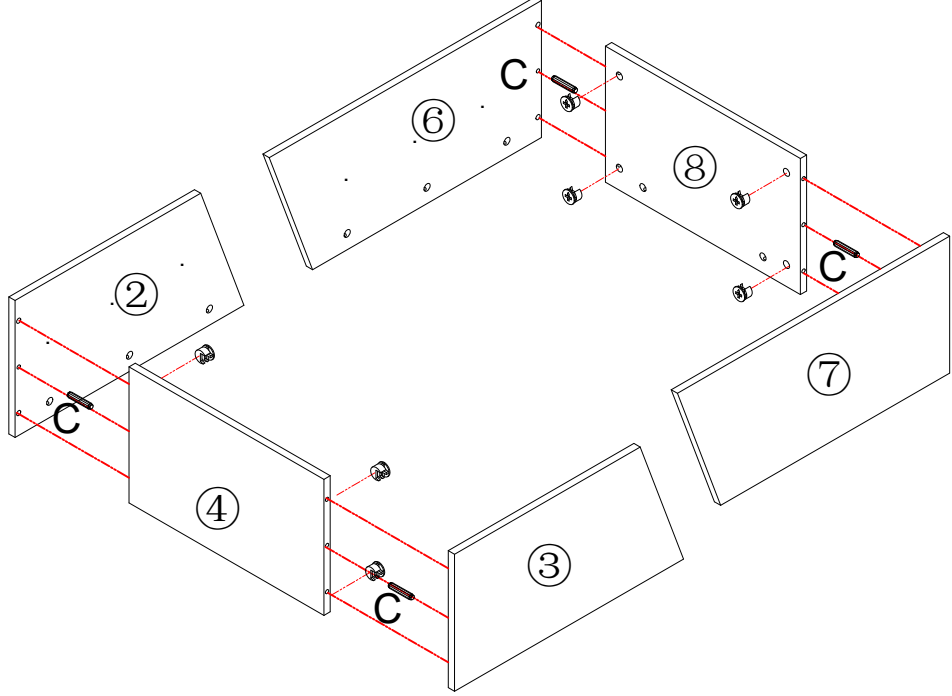

- B**  8PCS
8*40
- C**  4PCS

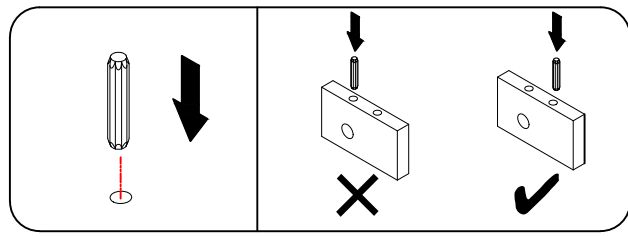
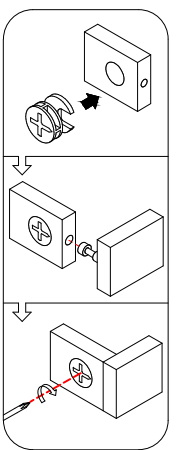

STEP 7



- B**  16PCS
8*40
- C**  12PCS

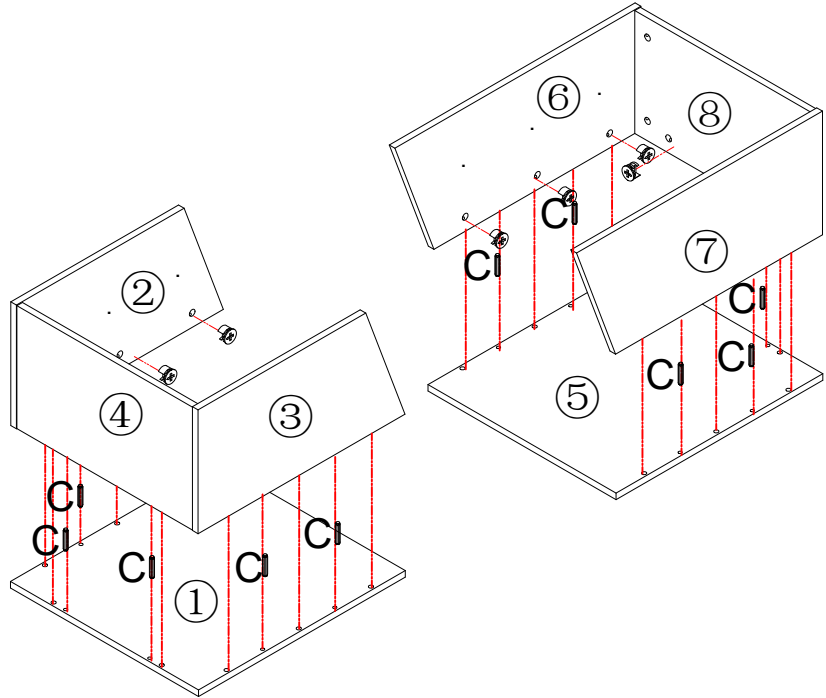

STEP 8

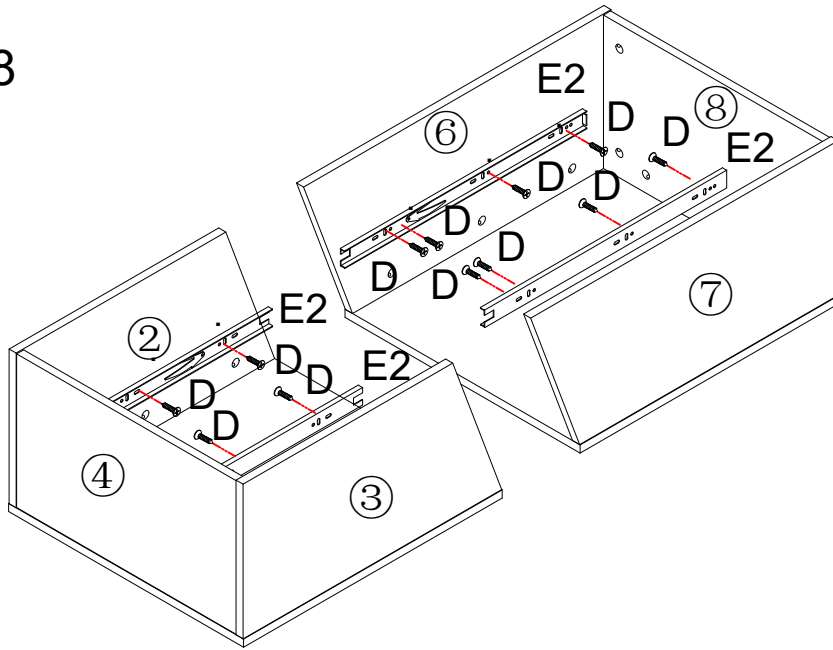

- D 3.5*14
16PCS
- E 450MM
E2 2PCS

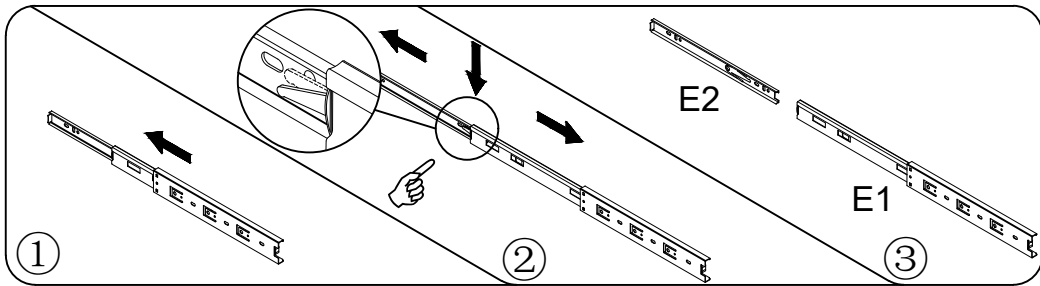

STEP 9

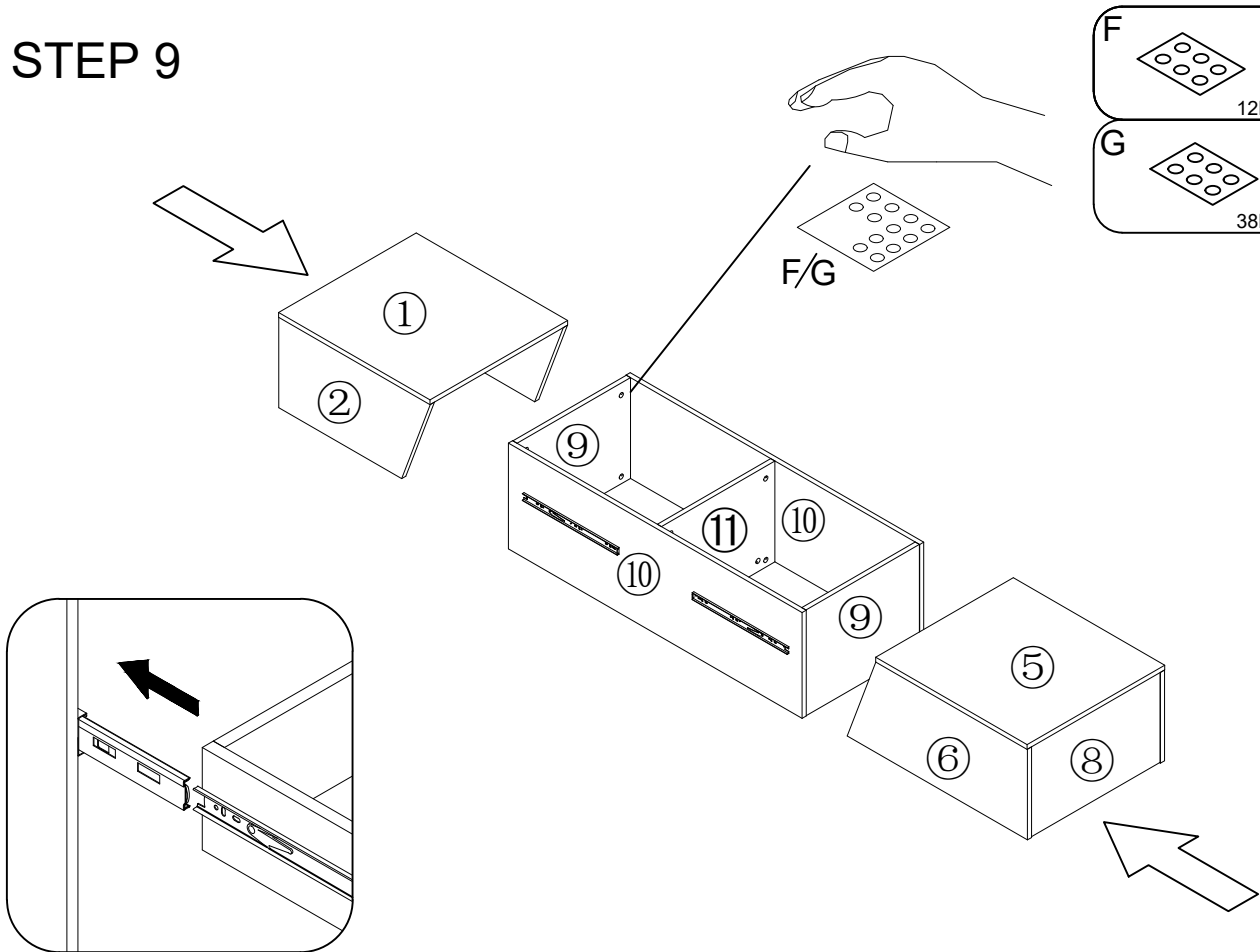

- F 12PCS
- G 38PCS