

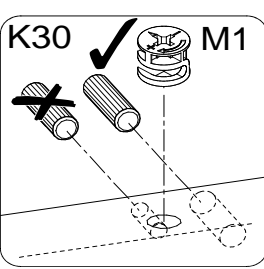

K30 4	T1 4	M1 4	X 4	KF 7	
X1 7	E5x9 4	ZM 2	K45 3	Q 1	KR 2

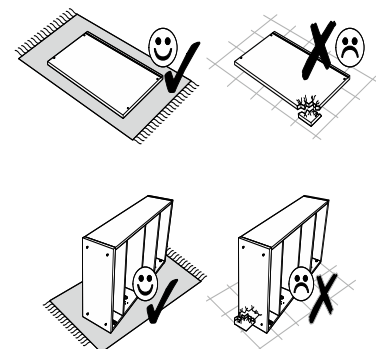

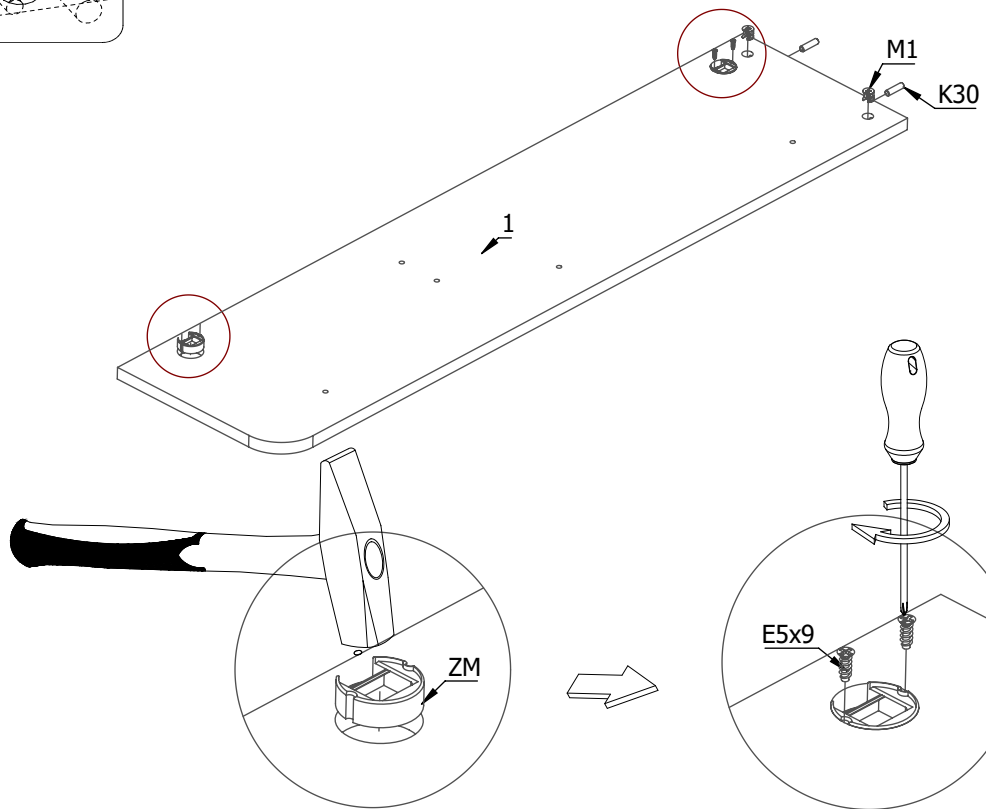

ZM 2	M1 2	E5x9 4	K30 2
--------------------	--------------------	----------------------	---------------------

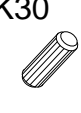

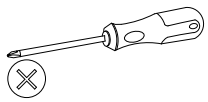
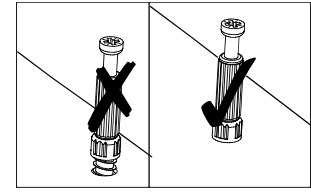
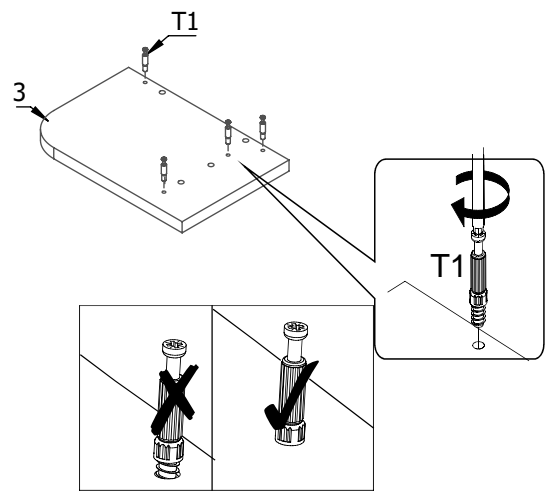
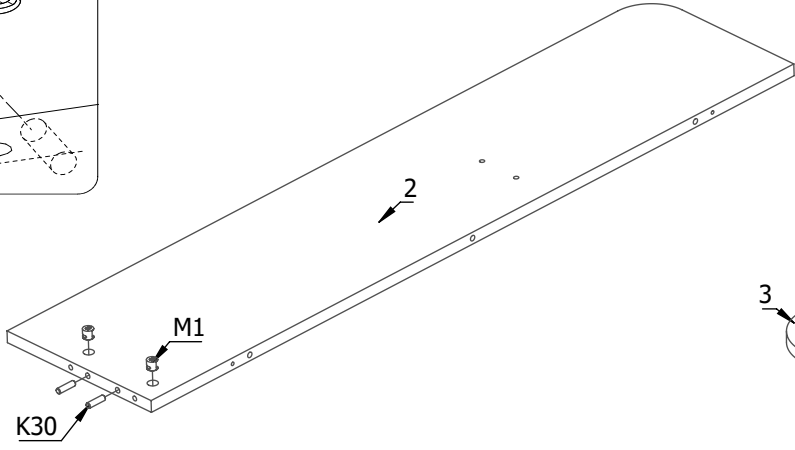
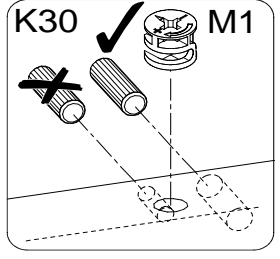
T1	M1	K30
		
4	2	2



K45	KF	Q
		
3	7	1

