

ABIRES

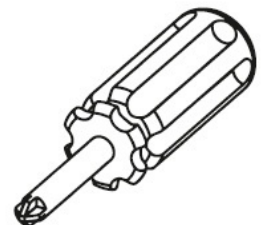

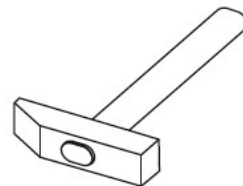
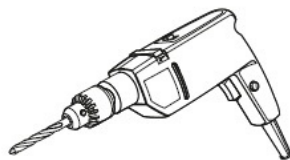
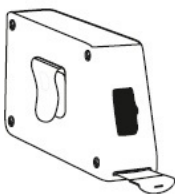
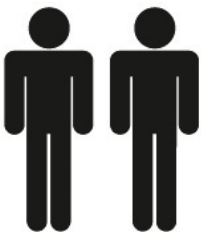
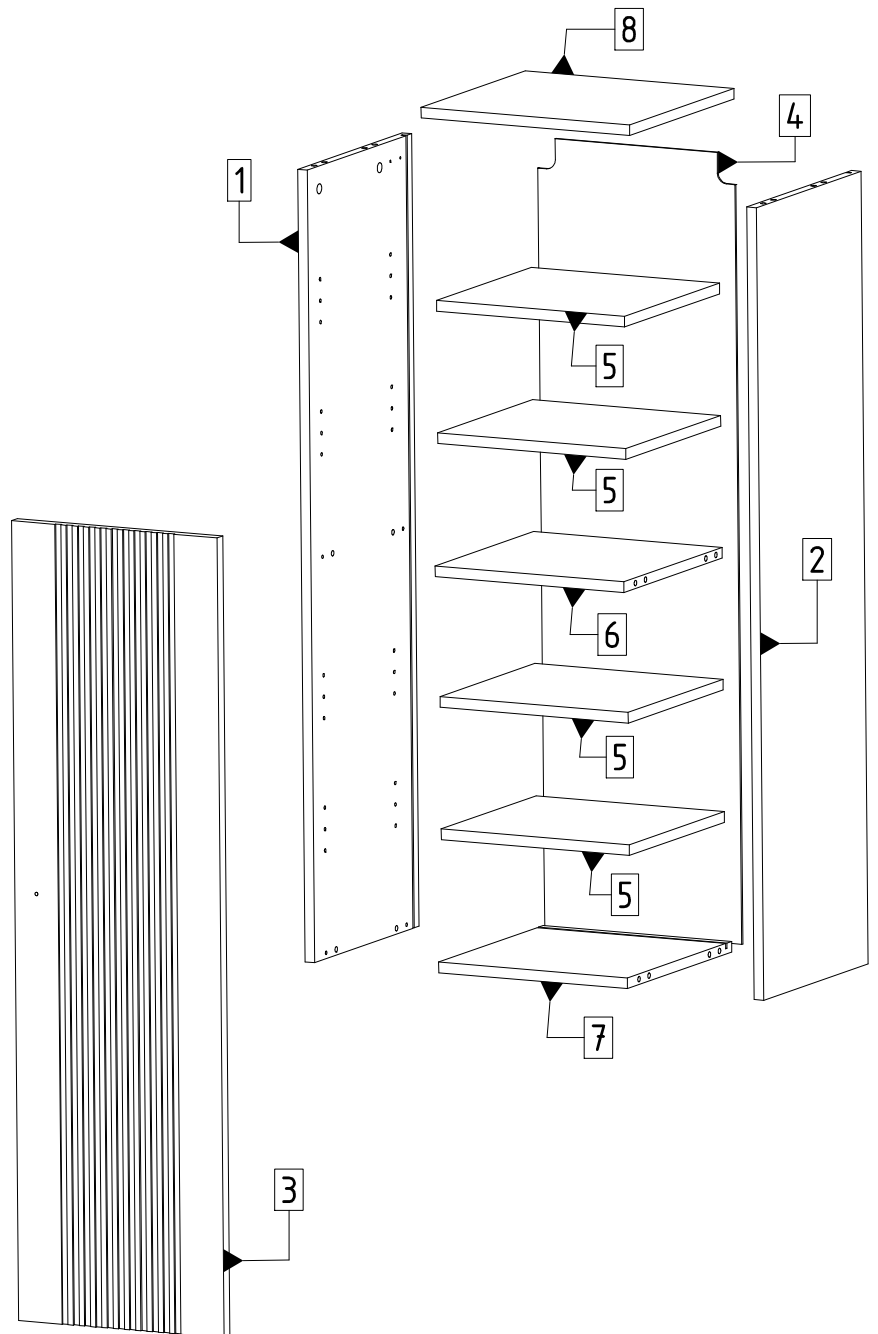
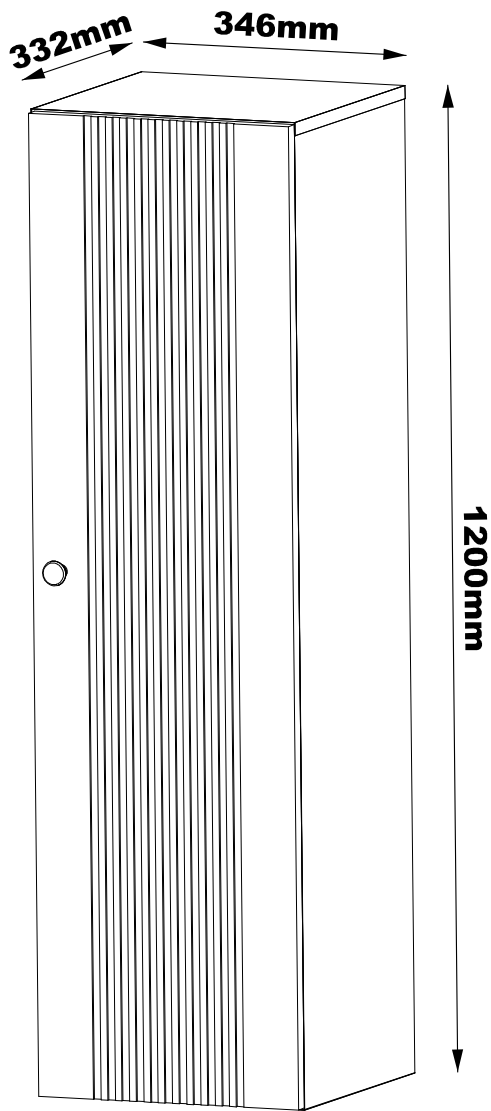

ABIRES 02

OP-216

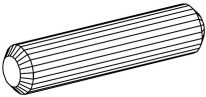

## Table accessories

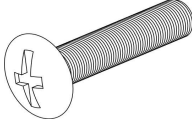
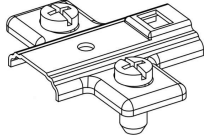
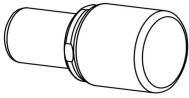
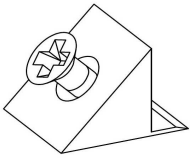
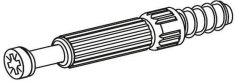
### ABIRES 02

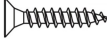
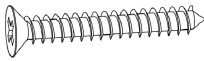
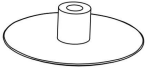
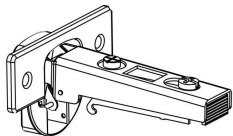
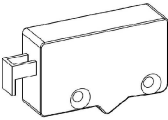
<p>8 x 30</p>  <p><b>K</b></p>	<p>15 x 12</p>  <p><b>M</b></p>	<p>4 x 25</p>  <p><b>M25</b></p>	 <p><b>PE</b></p>	 <p><b>PP3</b></p>
 <p><b>ST</b></p>	<p>6 x 34 mm</p>  <p><b>T</b></p>	 <p><b>UG2</b></p>	<p>4 x 16</p>  <p><b>W16</b></p>	<p>4 x 30 mm</p>  <p><b>W29</b></p>
 <p><b>Z</b></p>	 <p><b>ZPH</b></p>	<p>LEFT/RIGHT</p>  <p><b>ZR</b></p>		

Elements				Accessories	
SYMBOL	LENGTH	WIDTH	QUANTITY	SYMBOL	QUANTITY
BL (1)	332	1184	1	K	12
BP (2)	332	1184	1	M	12
FT (3)	341	1195	1	M25	1
PC (4)	1181	327	1	PE	3
PK (5)	312	302	4	PP3	16
PPO (6)	313	313	1	ST	12
WD (7)	332	313	1	T	12
WG (8)	346	332	1	UG2	1
				W16	6
				W29	4
				Z	12
				ZPH	3
				ZR	2

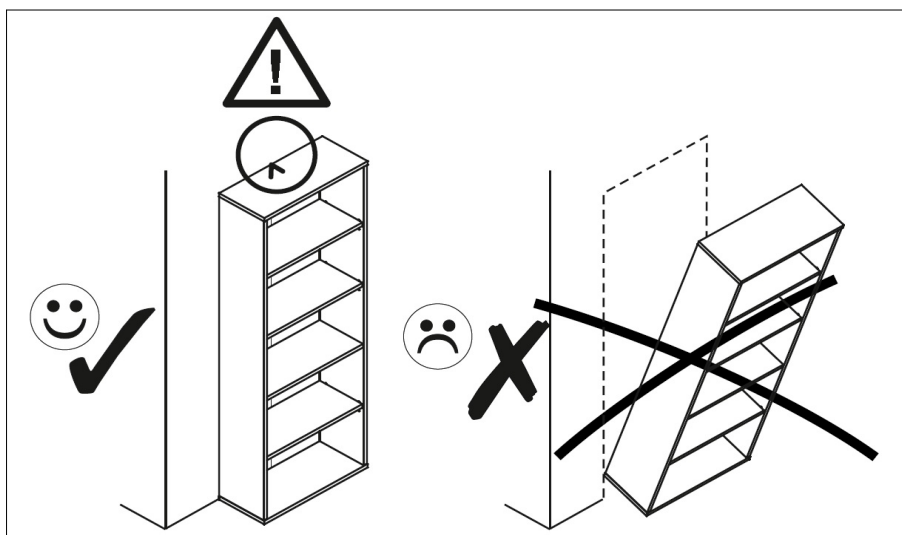

<p>PL  <b>UWAGA!</b> Mebel trzeba trwale zamocować do ściany, aby uniknąć przewrócenia się mebla. W paczce są akcesoria przystosowane wyłącznie do ścian betonowych i z pełnej cegły. Jeśli nie jesteś pewien co do budowy ściany, skonsultuj się ze specjalistą.</p>	<p>EN  <b>ATTENTION!</b> The furniture must be permanently attach to the wall, to avoid falling over furniture. There are accessories in the package adapted only to the walls concrete and solid brick. If you are not sure about the constructionwalls, consult expert.</p>	<p>NL  <b>LET OP!</b> Het meubel moet stevig aan de muur worden bevestigd om te voorkomen dat het omvalt. Het pakket bevat accessoires die alleen geschikt zijn voor betonnenen volle bakstenen muren. Als je niet zeker bent over de constructie van je muur, raadpleeg een specialist</p>
<p>IT  <b>NOTA!</b> I mobili devono essere permanenti attaccare al muro, per evitare di cadere mobili. Ci sono accessori nel pacchetto adattato solo alle pareti mattone concreto e solido. se non sei sicuro della costruzione muri, consultare specialista.</p>	<p>D  <b>ACHTUNG!</b> Die Möbel müssen dauerhaft seinan der Wand befestigen,um nicht umzufallen Möbel. Es gibt Zubehör in der Verpackung nur an die Wände angepasst Beton und Vollziegel. wenn Sie sind sich nicht sicher über die Konstruktion Wände konsultieren Spezialist.</p>	<p>ES  <b>NOTA!</b> La pieza necesita ser permanentemente pegar a la pared, para evitar caerse muebles. Estan en el paquete accesorios adaptados solo para paredes Hormigón y ladrillo macizo. si no estás seguro de la construcción Paredes, consultar a un especialista.</p>
<p>FR  <b>REMARQUE!</b> La pièce doit être en permanence attacher au mur, pour éviter de tomber meubles. Ils sont dans le paquet accessoires adaptés seulement pour les murs béton et brique pleine. si vous n'êtes pas sûr de la construction murs, consultez un spécialiste.</p>	<p>CZ  <b>POZOR!</b> Kus musí být natrvalo připevnit ke zdi, aby se zabránilo pádu nábytek. Jsou v balení příslušenství přizpůsobené pouze pro stěny betonové a pevné cihly. pokud Nejste si jisti stavbou konzultovat odborníka.</p>	<p>SLO  <b>POZOR!</b> Kus musí byť natrvalo pripojit' k stene, aby sa zabránilo pádu nábytok. Sú v balení príslušenstvo prispôsobené len pre steny betón a pevné tehly. ak Nie ste si istý stavbou konzultujte s odborníkom.</p>

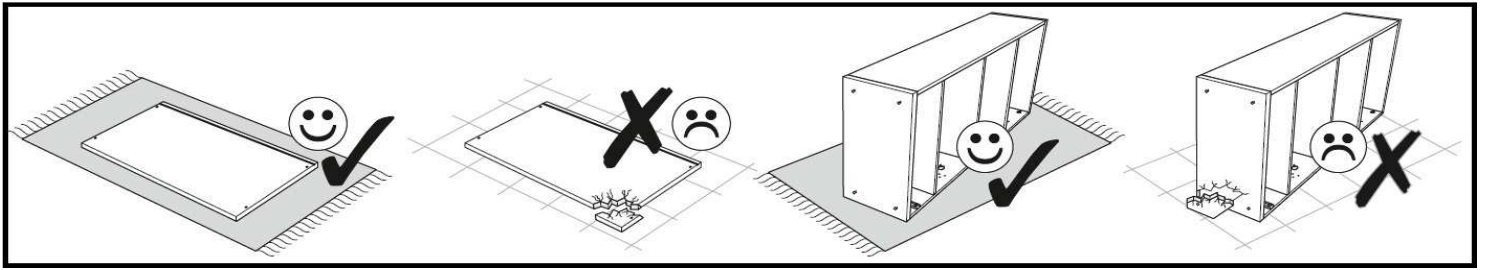

1.

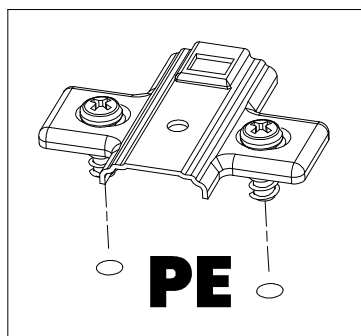
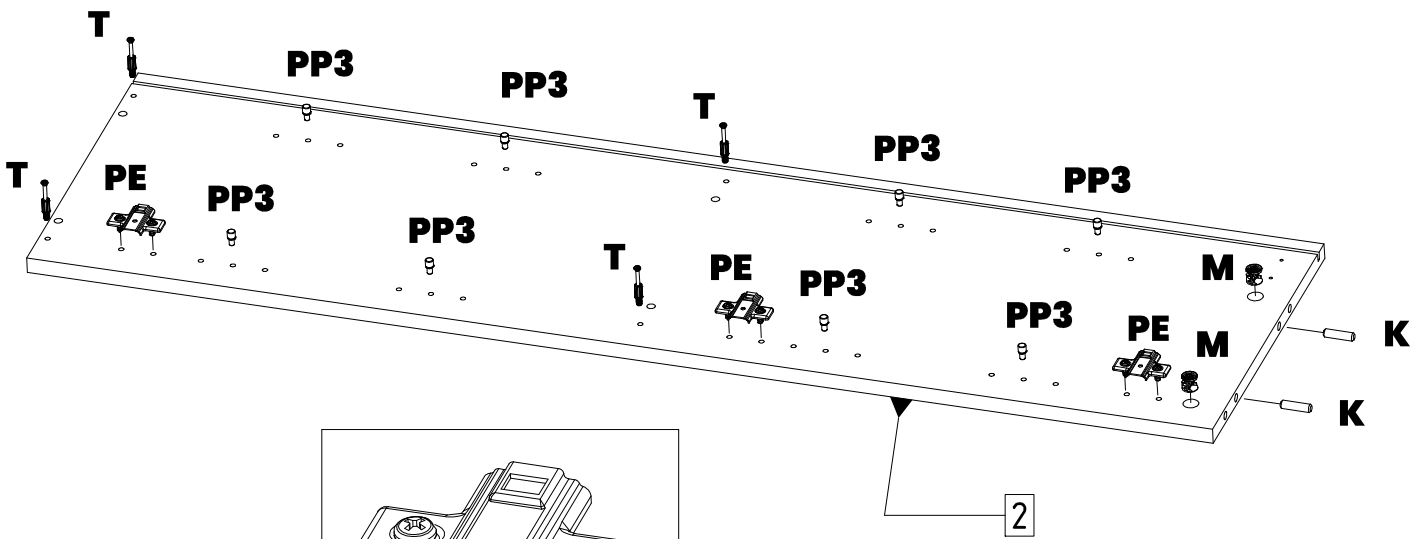
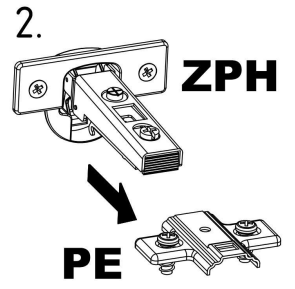
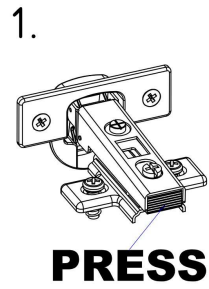
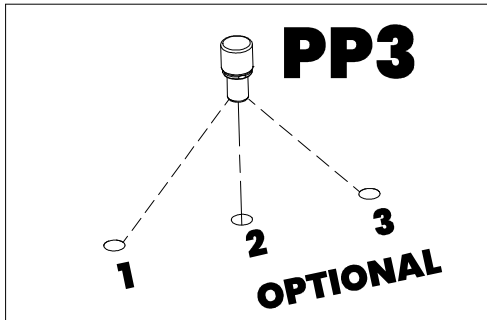
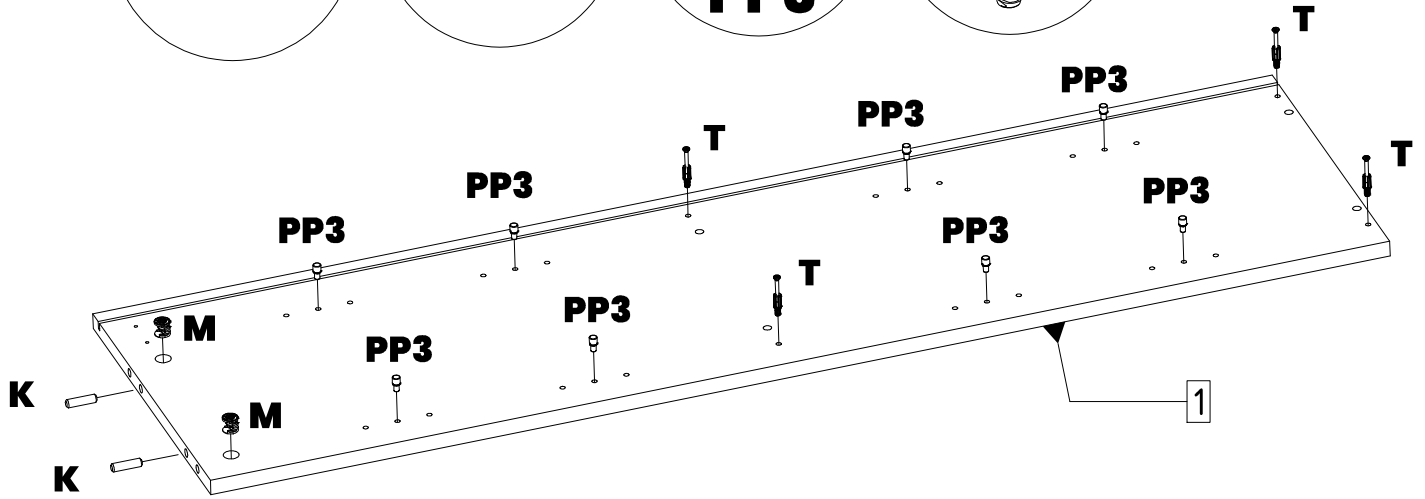
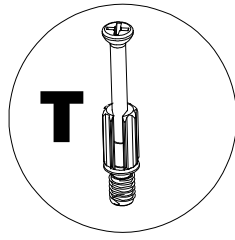
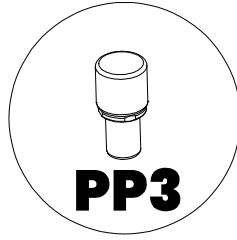
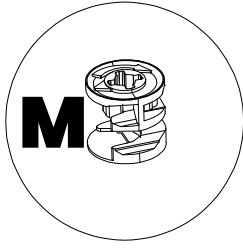
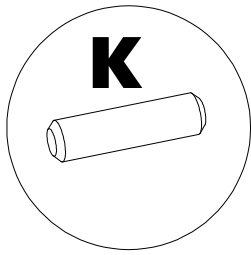

2.

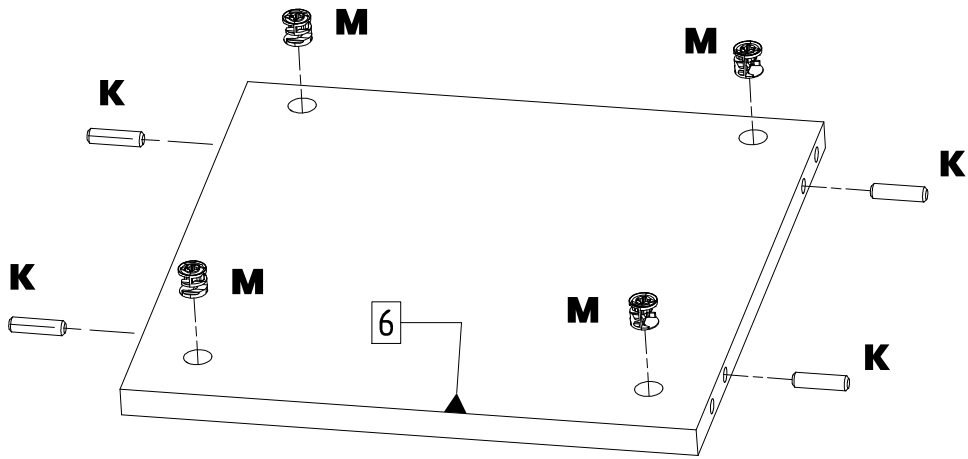
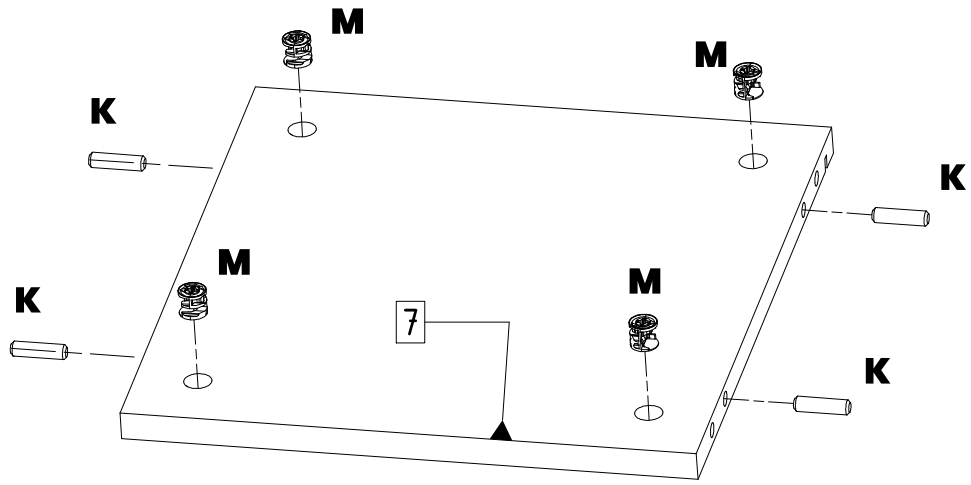

3.

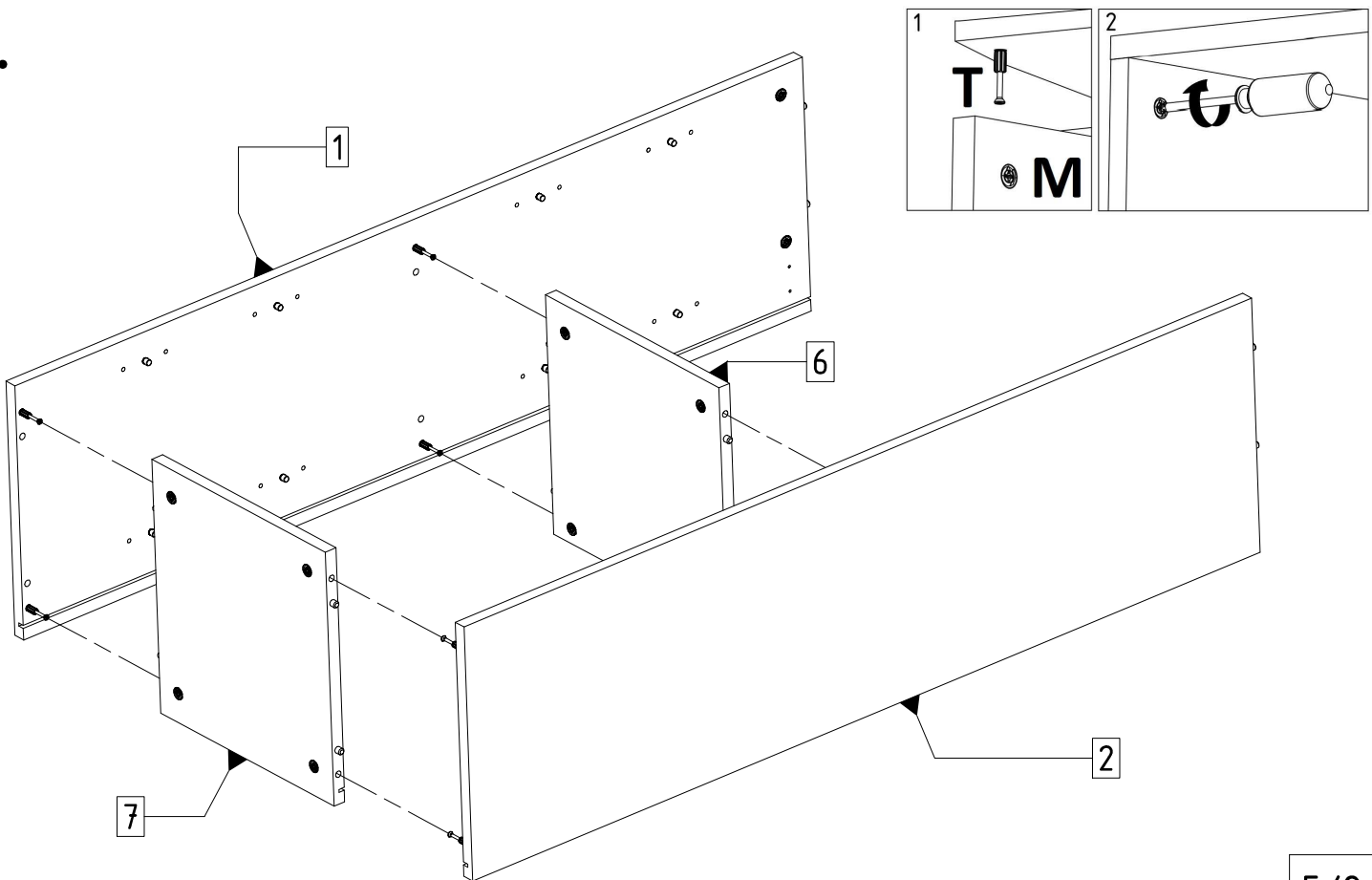

4.

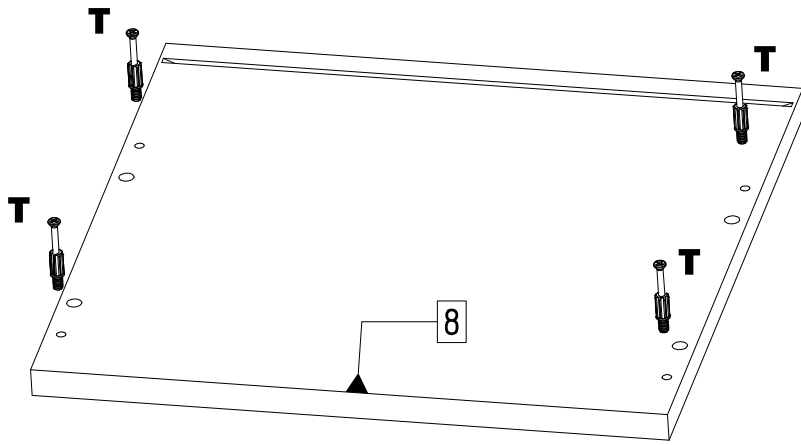

5.

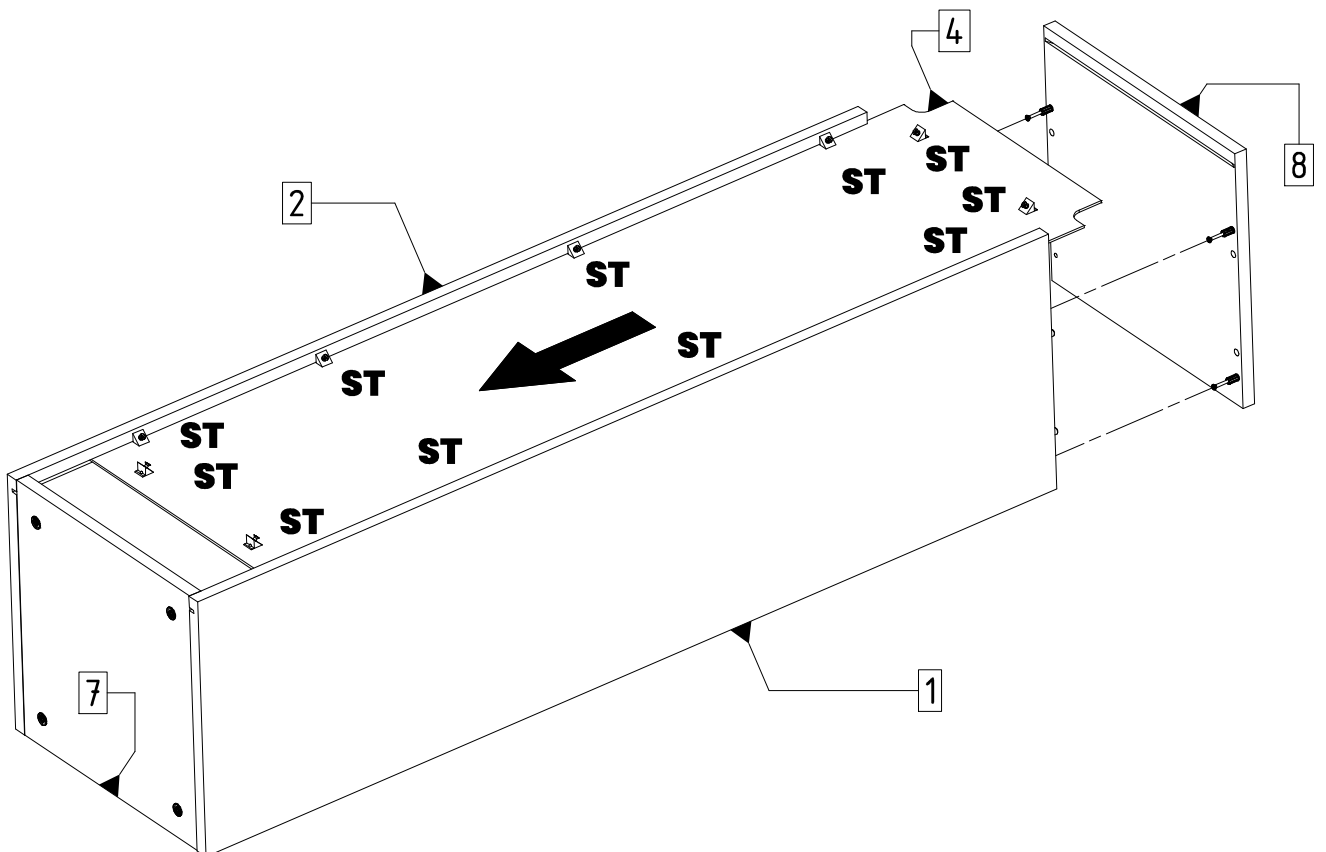
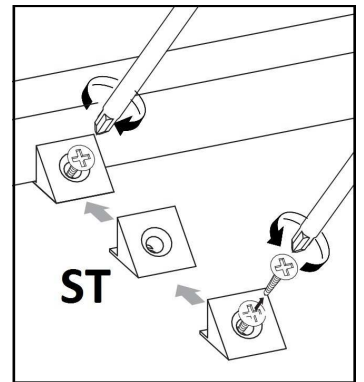
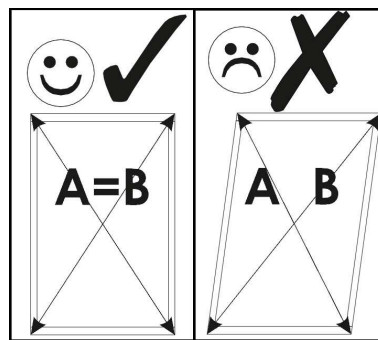
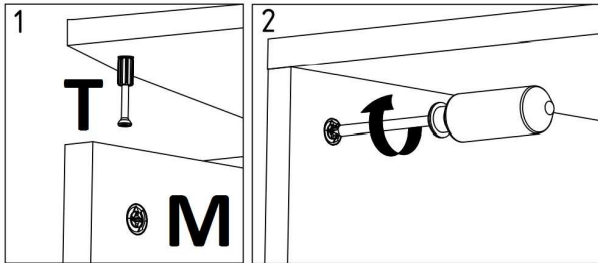

6.

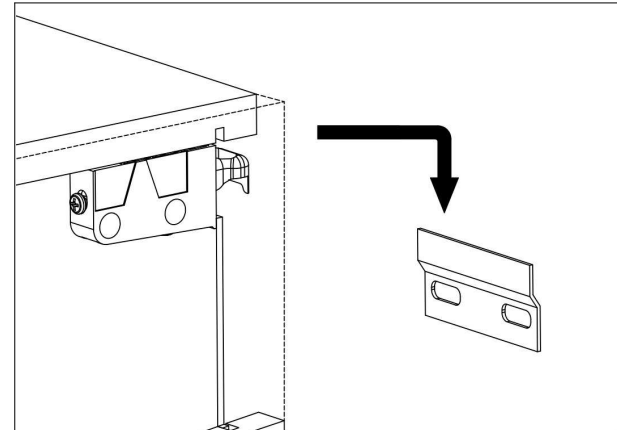
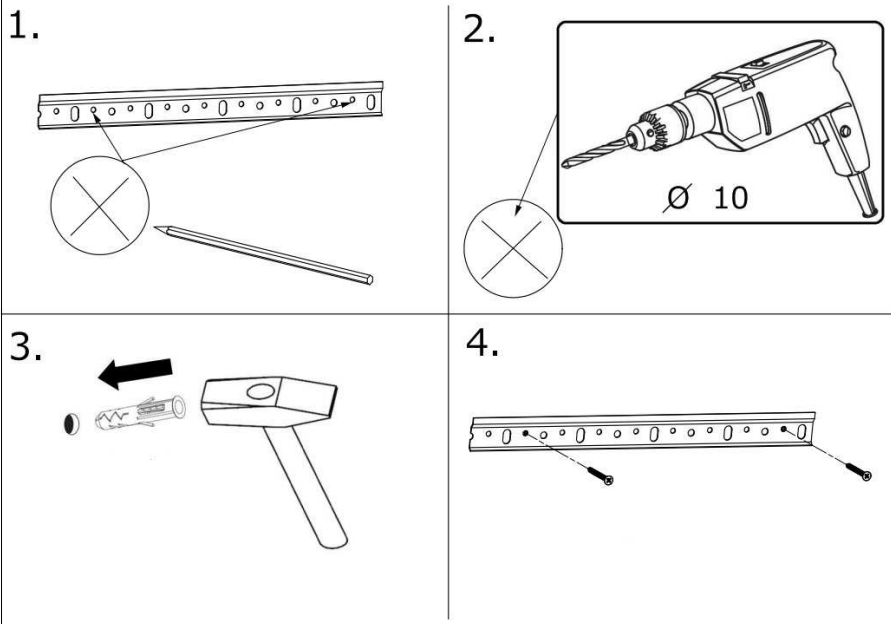
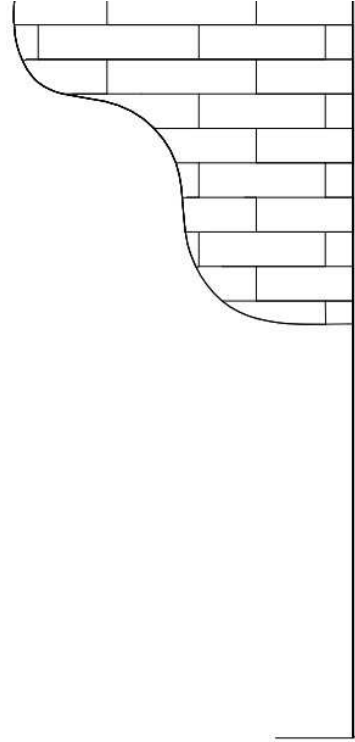
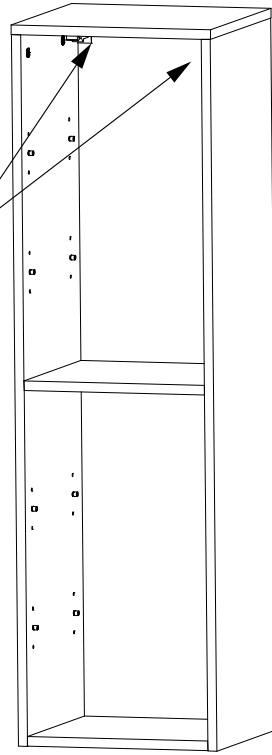
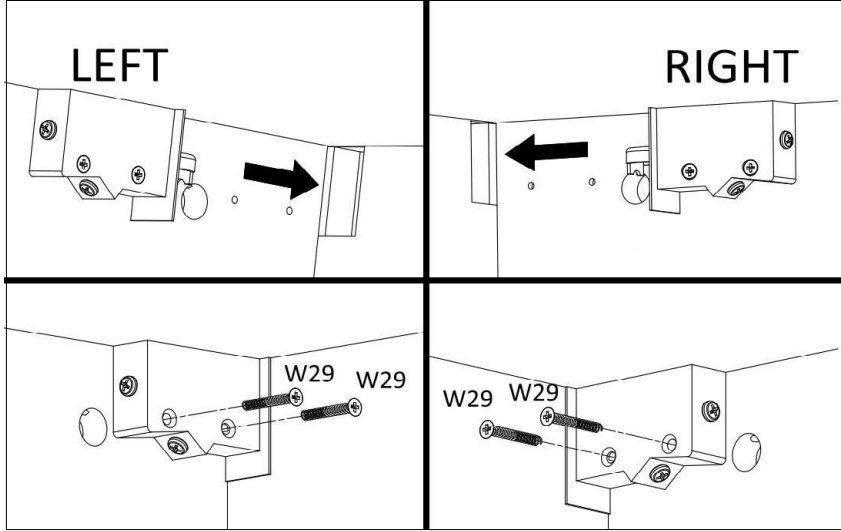

7.

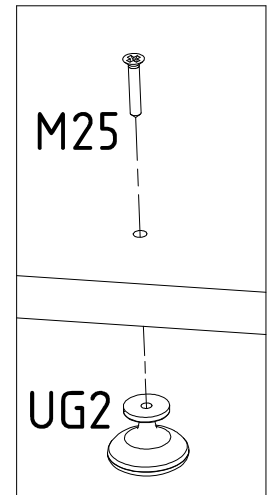
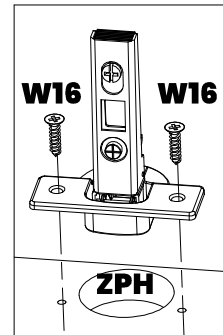
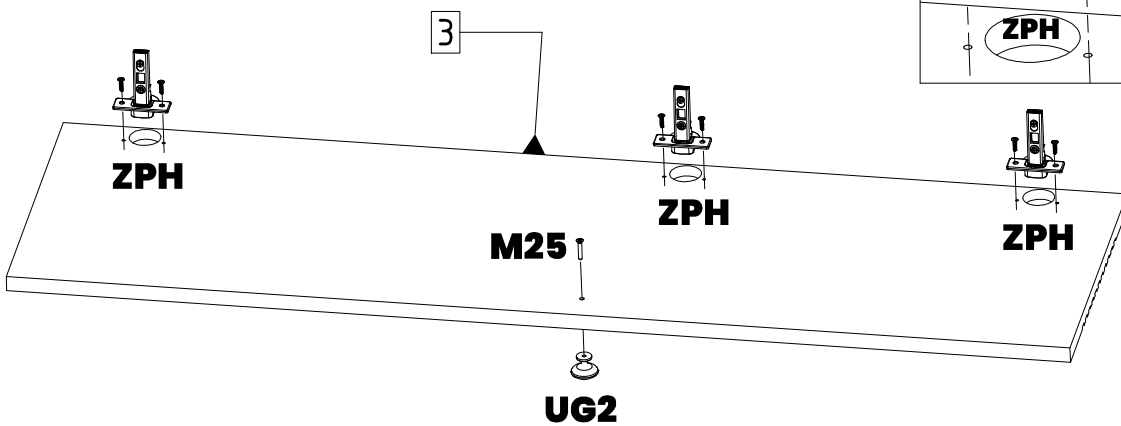

8.

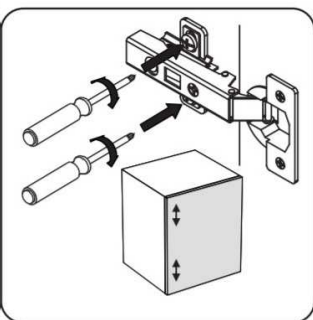
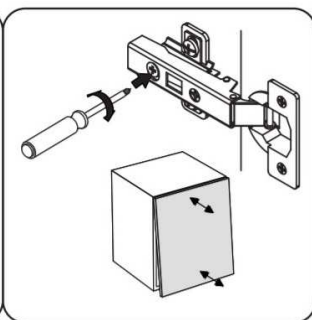
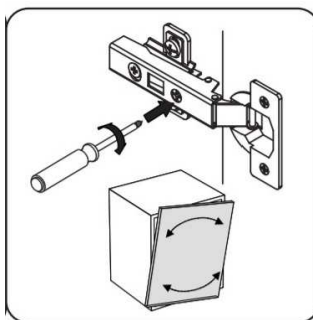
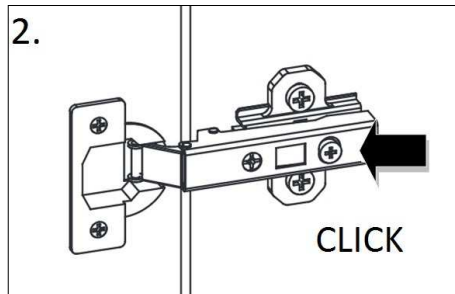
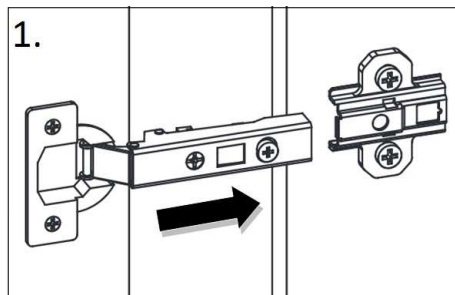
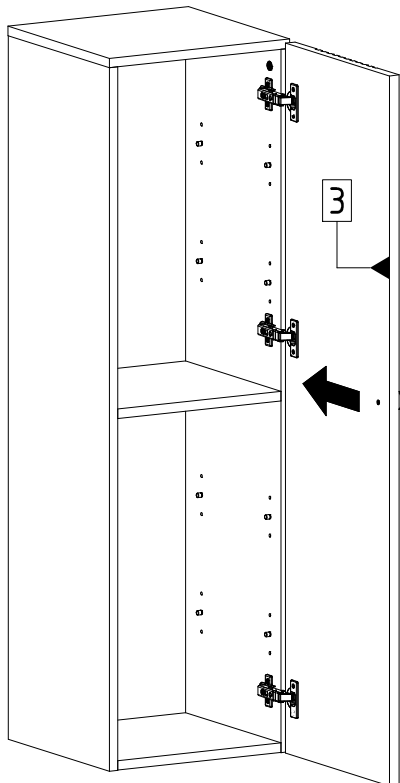

max.  
6 kg

