

Do montażu potrzebne są:
 Für die Montage dieser Type benötigen Sie:

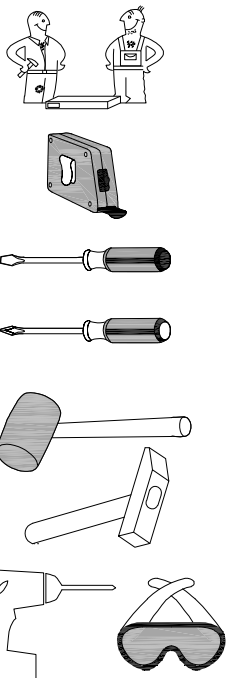

PL INSTRUKCJA MONTAŻU
 D MONTAGEANLEITUNG
 GB ASSEMBLY INSTRUCTIONS

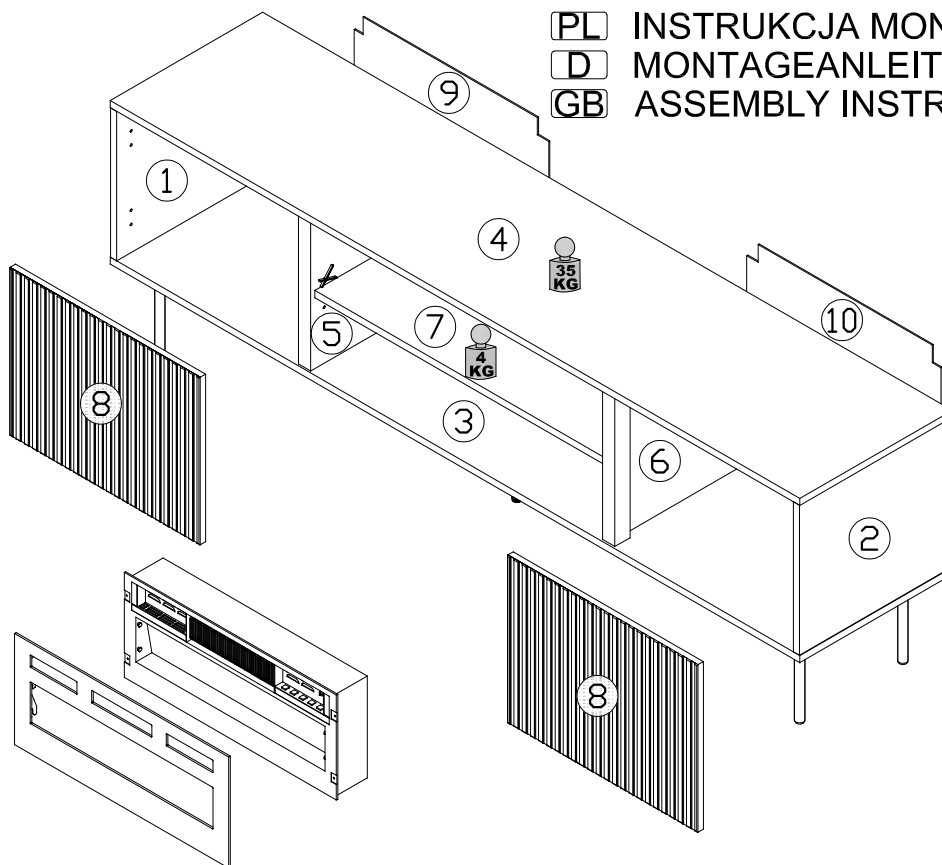

PL Szanowny Kliencie, gdyby brakowało jakiejś części lub byłaby uszkodzona proszę to oznaczyć krzyżykiem na instrukcji montażowej i przesłać instrukcję razem z reklamacją.
 D Sehr geehrter Kunde, sollte ein Teil fehlen oder beschädigt sein, kreuzen Sie bitte dieses deutlich auf der Montageanleitung an und schicken Sie zu uns ab.
 GB Dear customer, Should there be any place missing or damaged, kindly mark this place clearly on the attached assembly instructions and return it to us.

PL Proszę wycierać ściereczką do kurzu lub lekko wilgotną ścierką. Nie stosować ŻADNYCH środków rysujących powierzchnie.
 D Bitte nur mit einem Staubtuch oder einem feuchtem Lappen reinigen. KEINE scheuernde Putzmittel verwenden!

GB Please clean with a duster or a slightly damp cloth. Do not use any substances that scratch the surfaces.

PL Szanowny kliencie, jeśli zamontujesz uszkodzony element, Twoja reklamacja nie będzie uznana. Zachowaj etykietę do celów reklamacyjnych.
 D Sehr geehrter Kunde, wenn Sie ein beschädigtes Element einbauen, wird Ihre Reklamation nicht akzeptiert. Bewahren Sie das Etikett für Reklamationszwecke auf.

GB Dear customer, if you install a damaged element, your complaint will not be accepted. Keep the label for complaint purposes.

HANGING OPTION

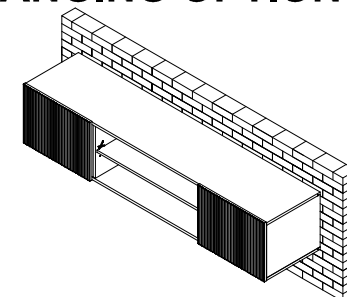

STANDING OPTION

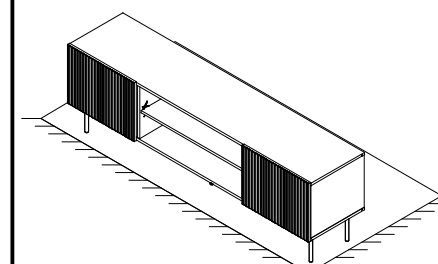

| REP | DIM | QTY | PACK |
|-----|-----------------|-----|------|
| 1 | 400 x 340 x 16 | 1 | 1/1 |
| 2 | 400 x 340 x 16 | 1 | 1/1 |
| 3 | 1806 x 400 x 16 | 1 | 1/1 |
| 4 | 1806 x 400 x 16 | 1 | 1/1 |
| 5 | 340 x 375 x 32 | 1 | 1/1 |
| 6 | 340 x 375 x 32 | 1 | 1/1 |
| 7 | 762 x 365 x 16 | 1 | 1/1 |
| 8 | 380 x 498 x 16 | 2 | 1/1 |
| 9 | 509 x 354 x 3 | 1 | 1/1 |
| 10 | 509 x 354 x 3 | 1 | 1/1 |

BAG 5

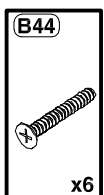
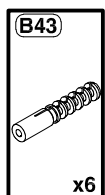
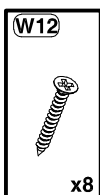
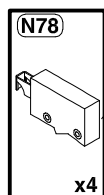

BAG 6

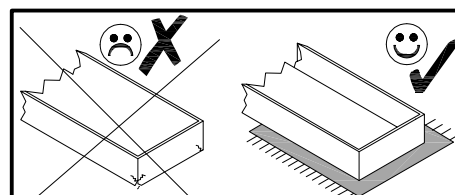
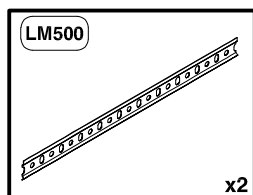

BAG 1

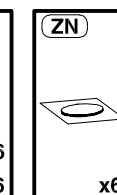
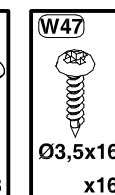
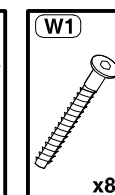
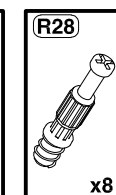
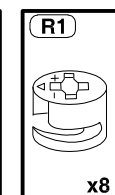
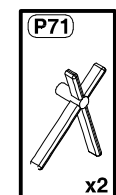
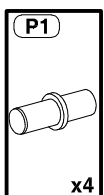
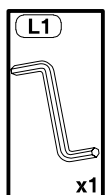
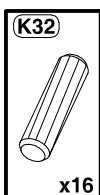
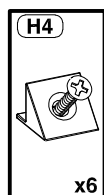

BAG 2

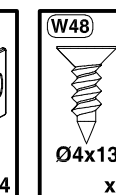
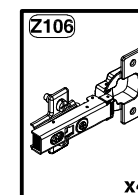

BAG 3

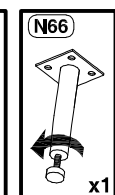
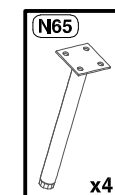

BAG 4

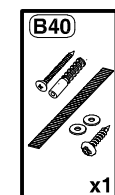

1

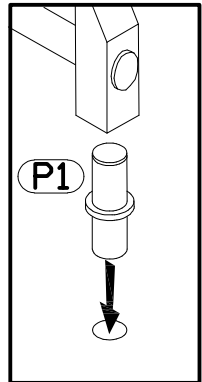
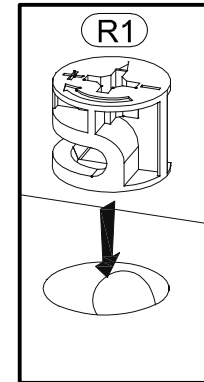
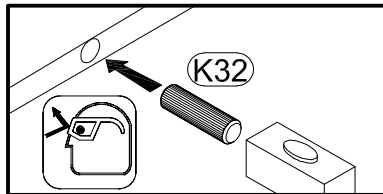
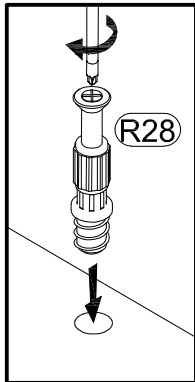
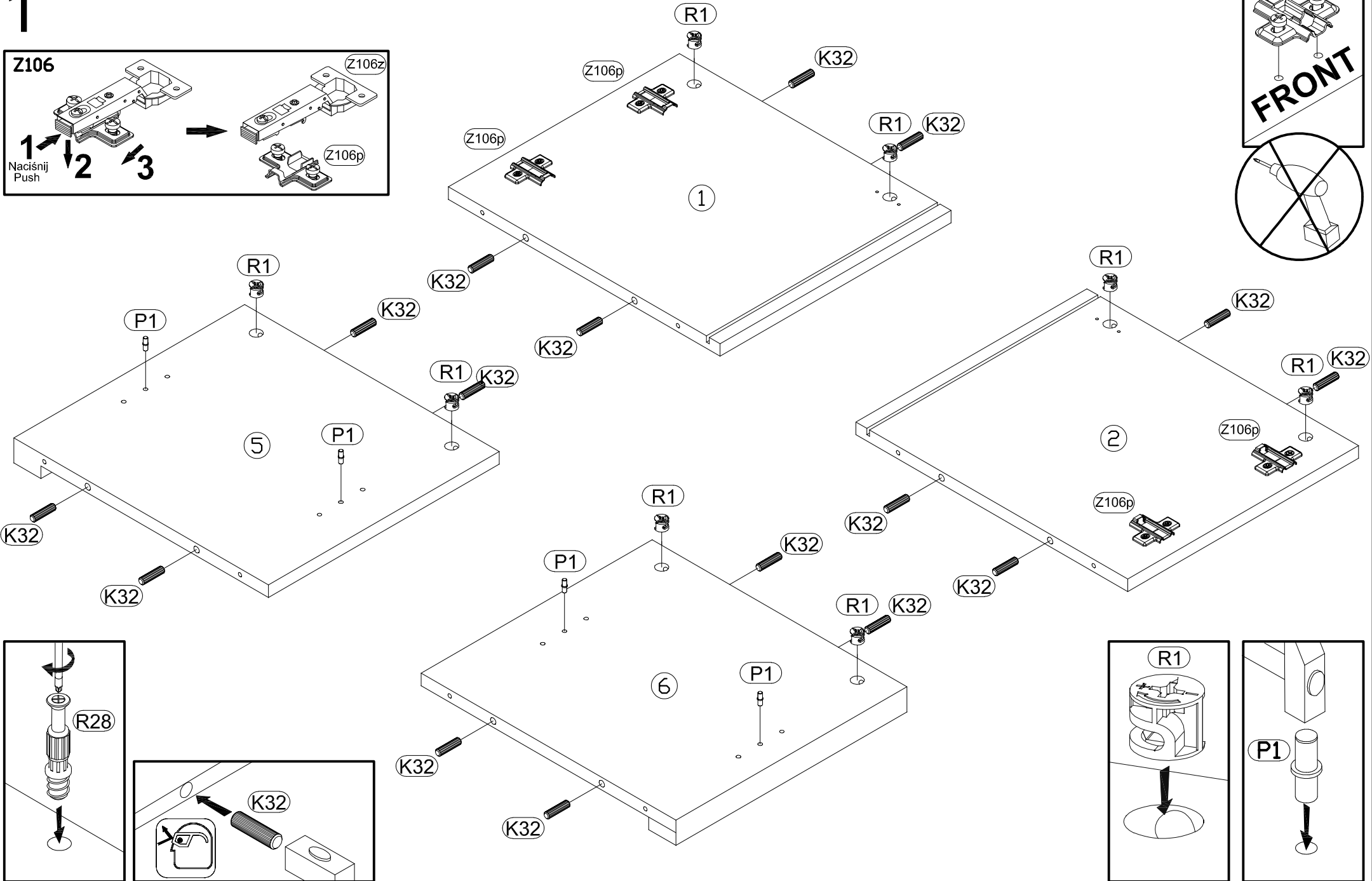
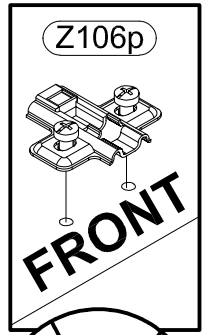
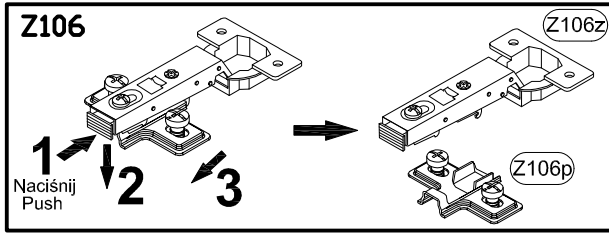

2

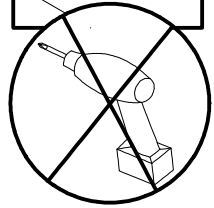
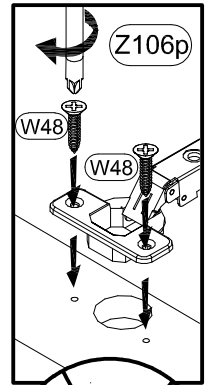
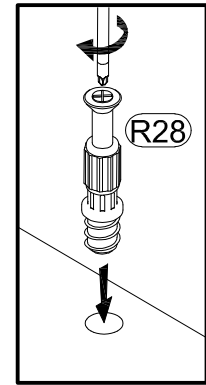
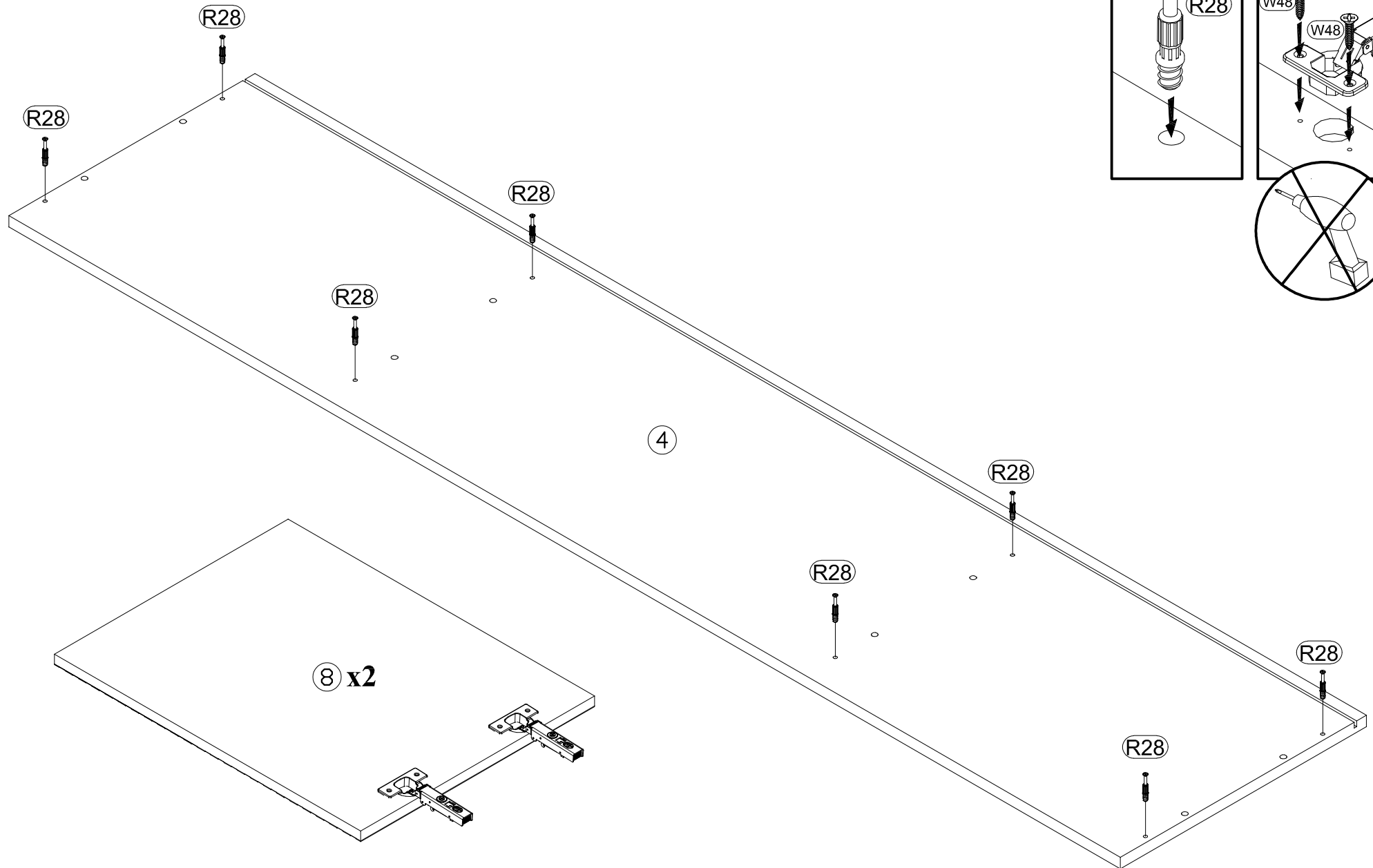

3

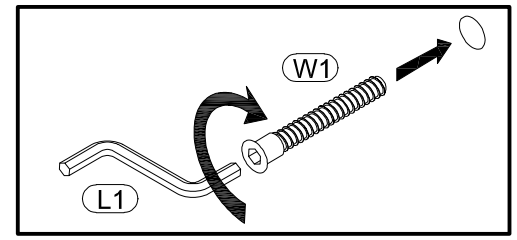
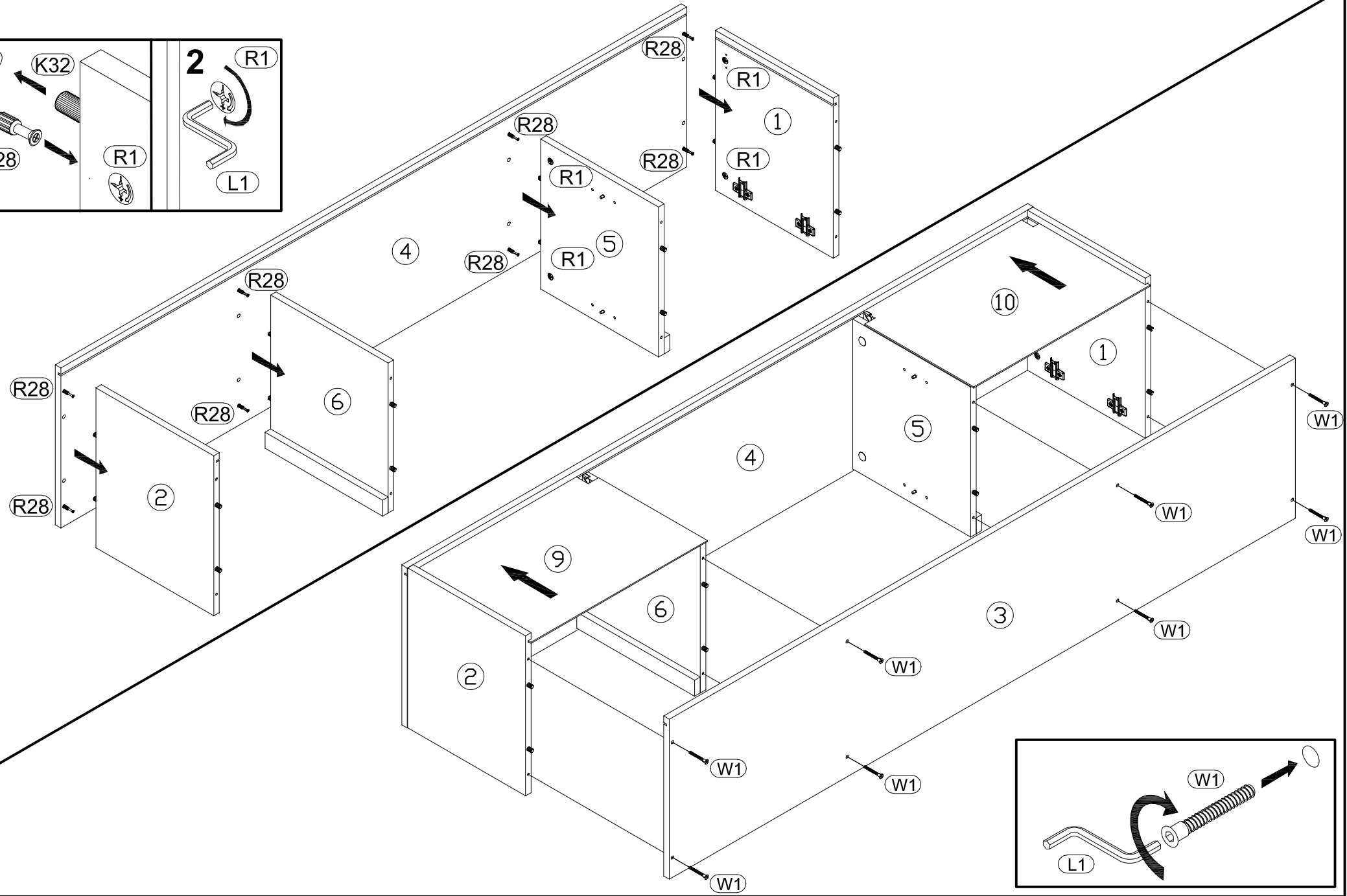
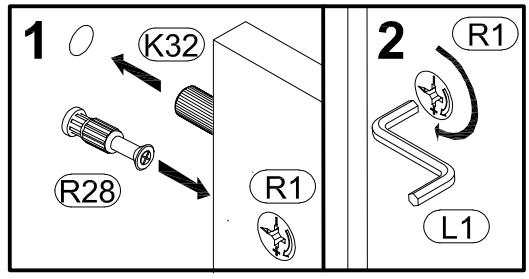

4

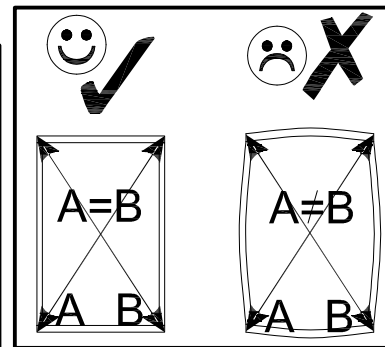
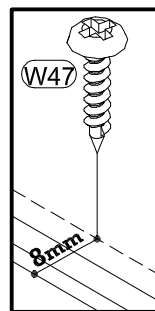
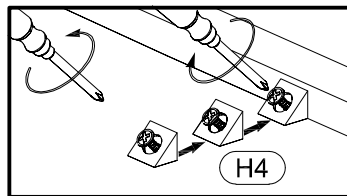
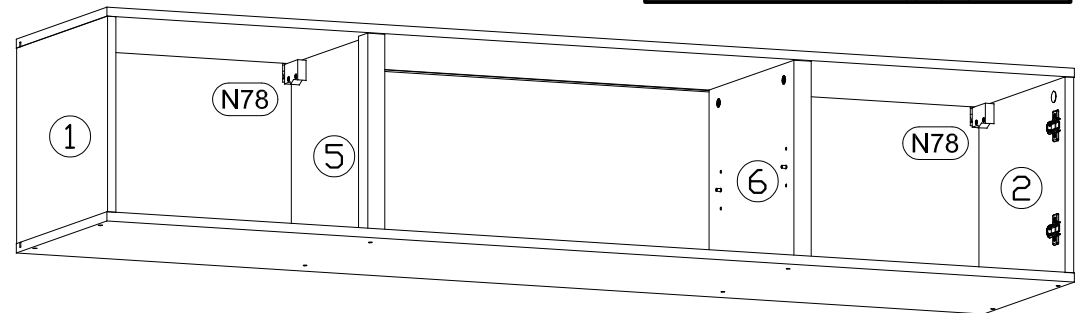
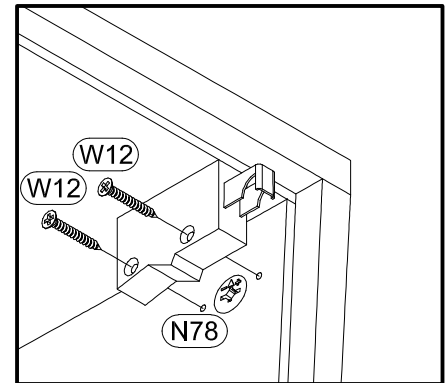
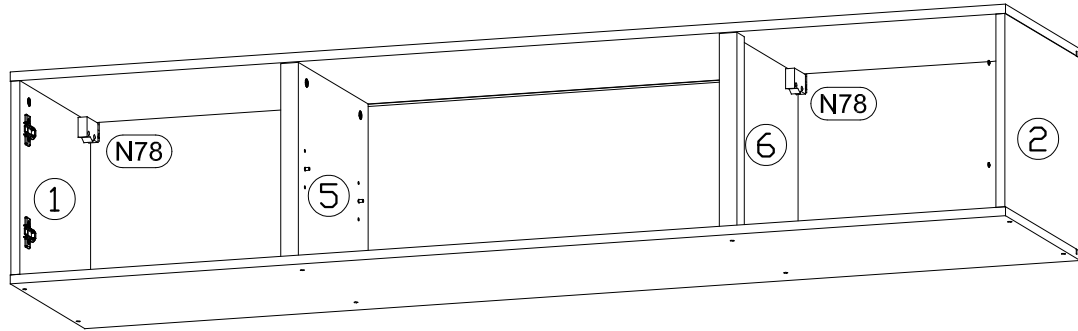
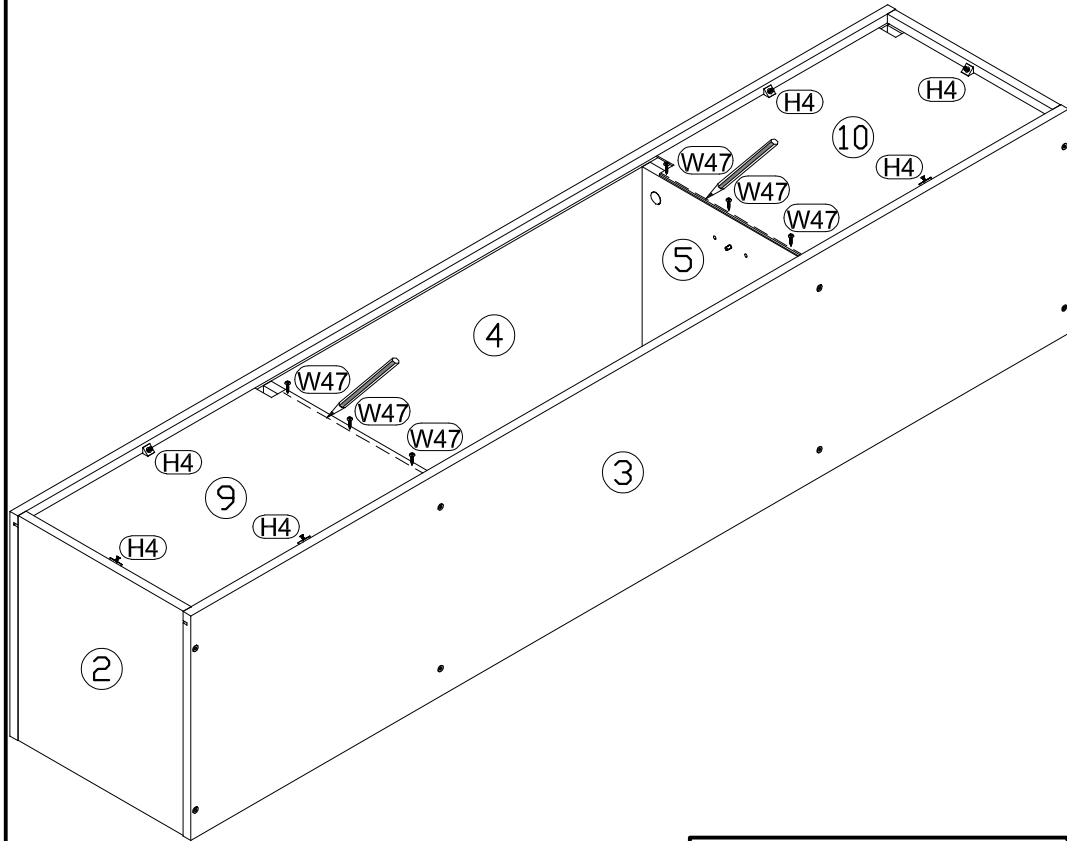

5 STANDING OPTION

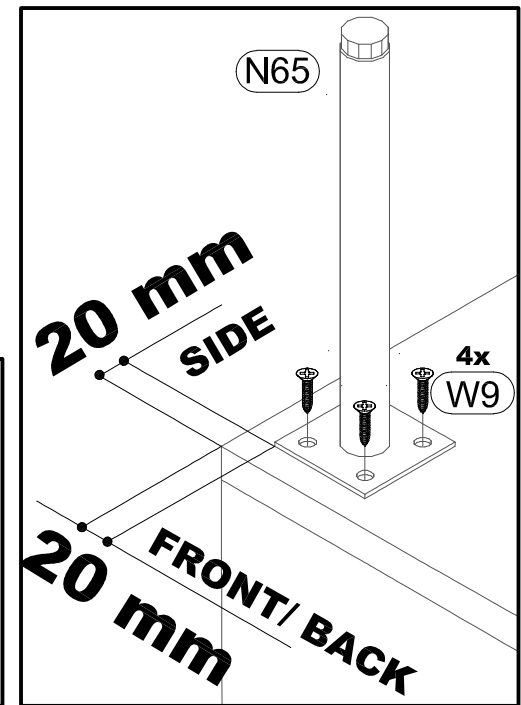
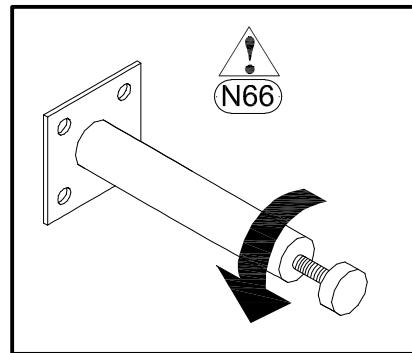
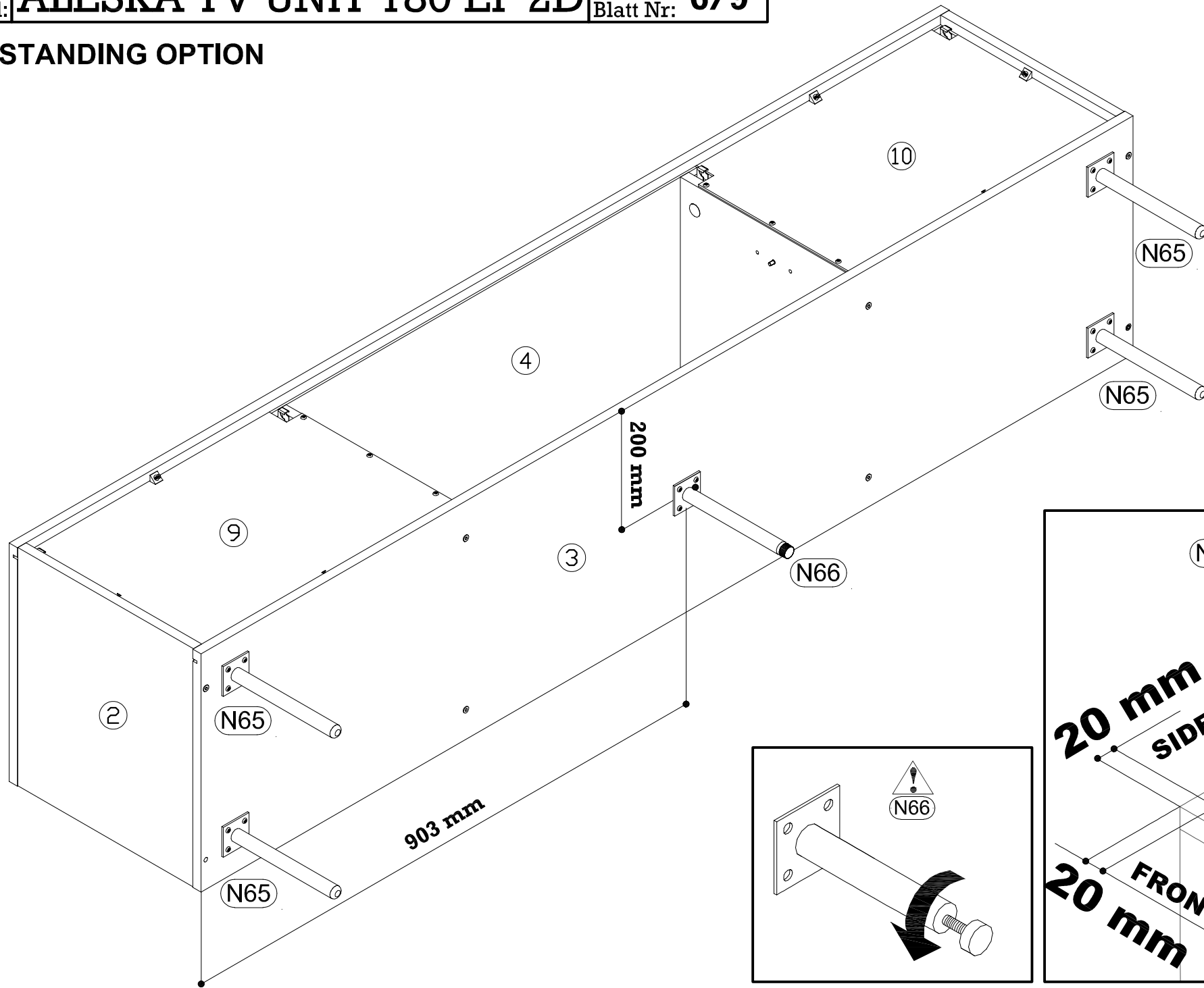

6 HANGING OPTION

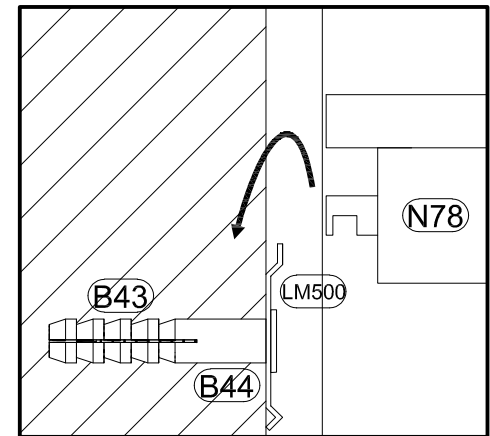
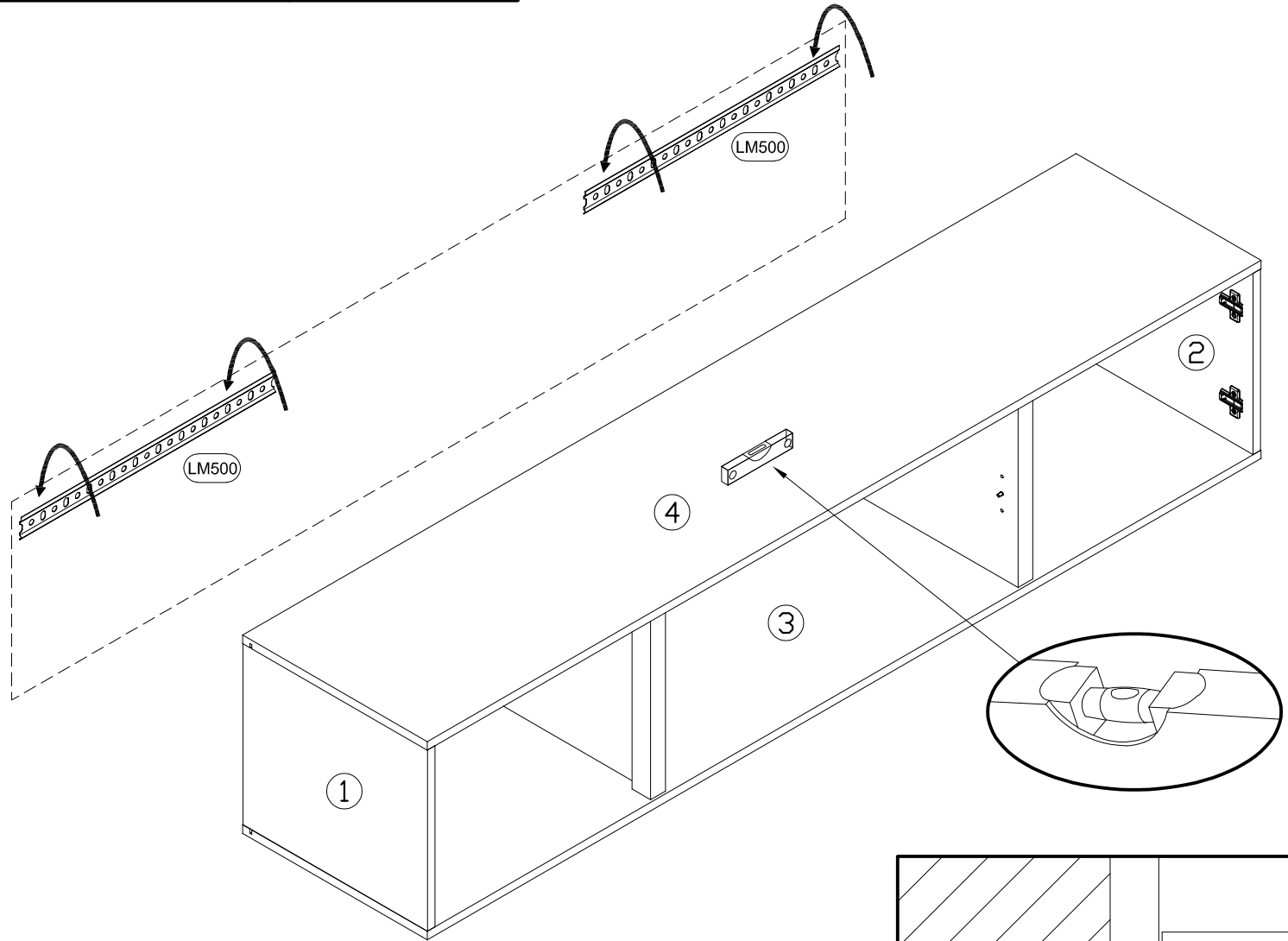
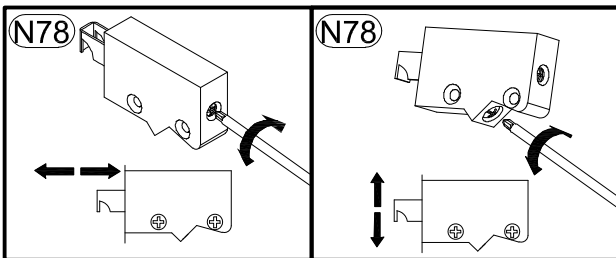
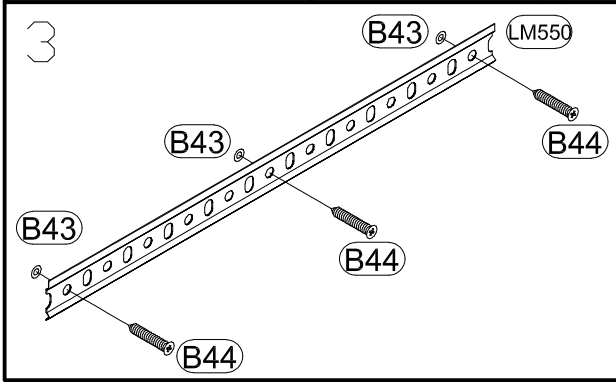
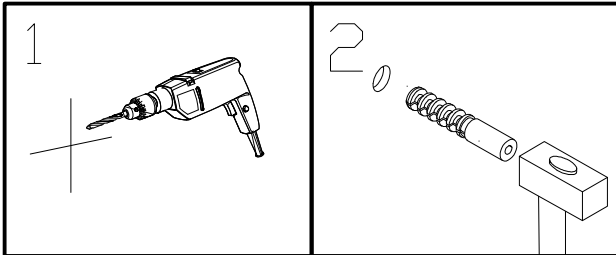
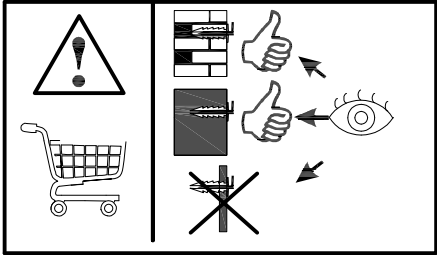

7

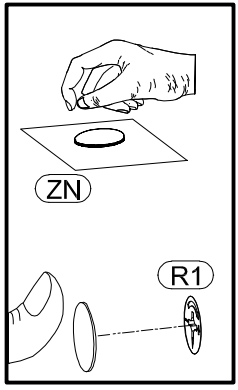
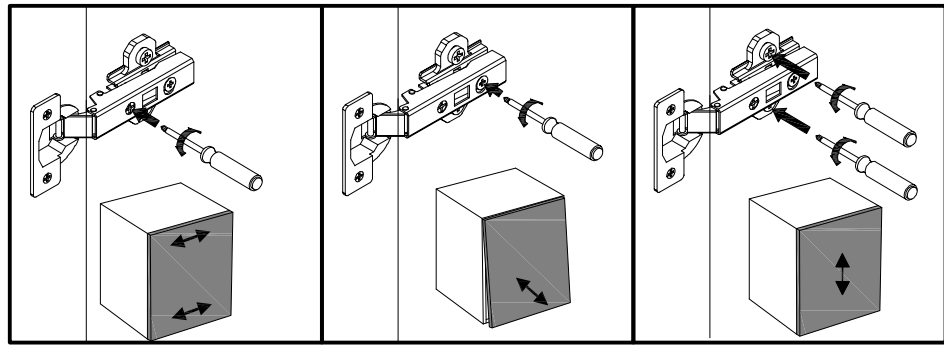
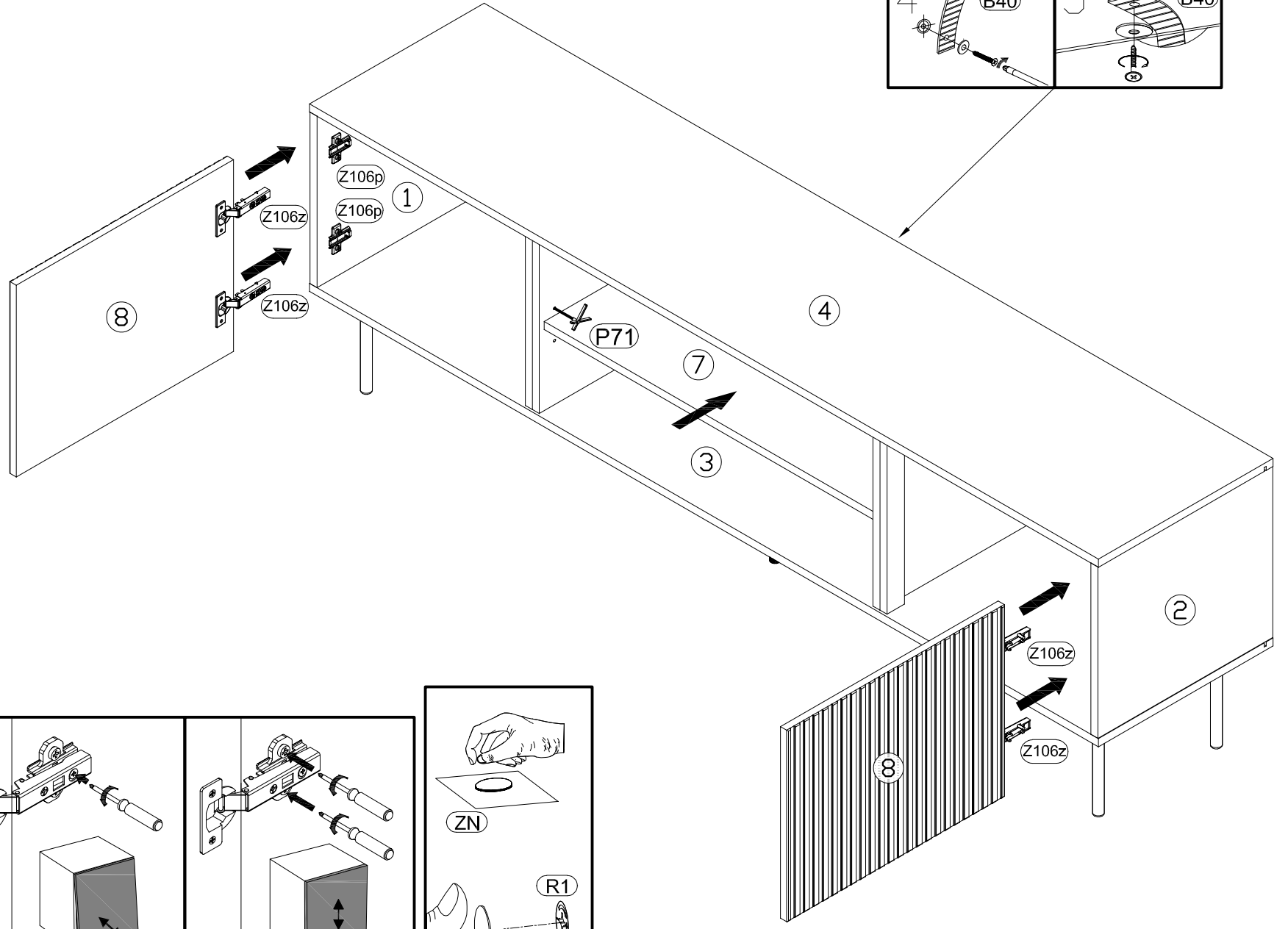
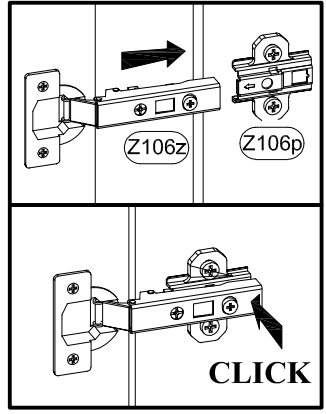
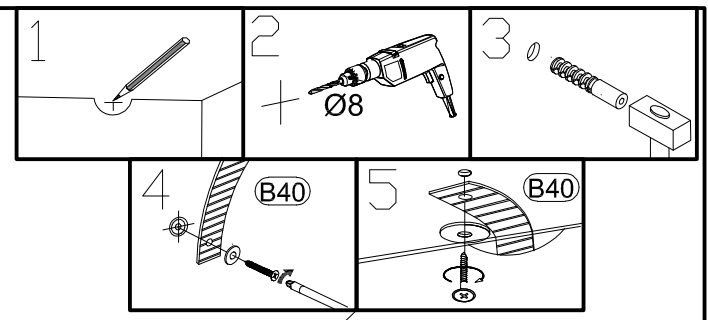

8

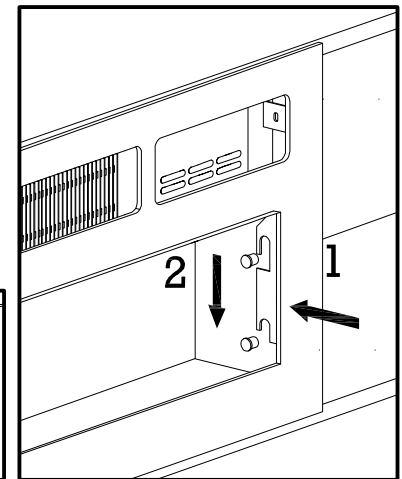
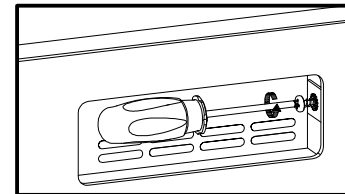
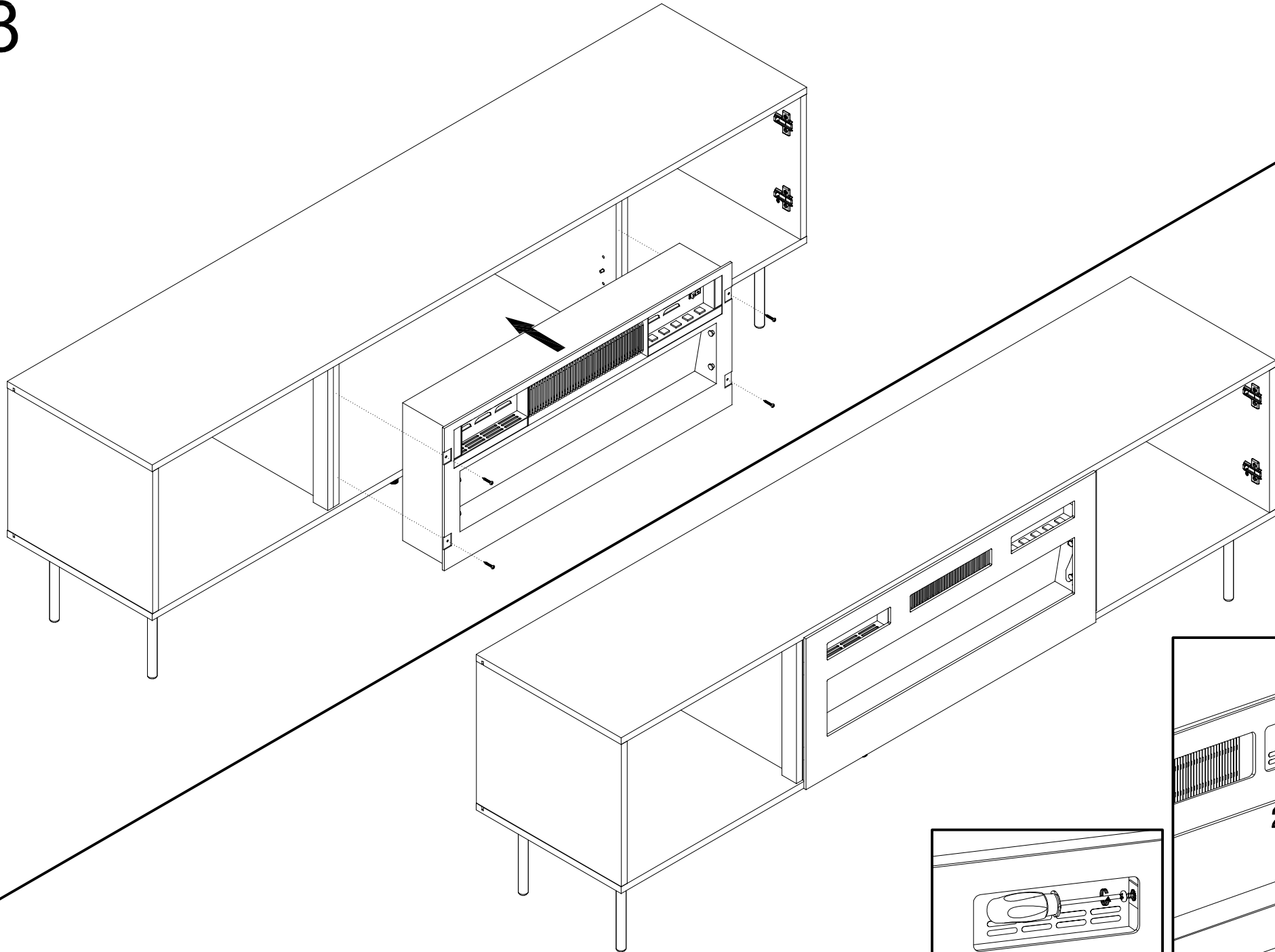

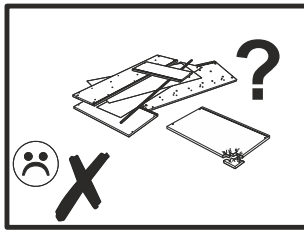
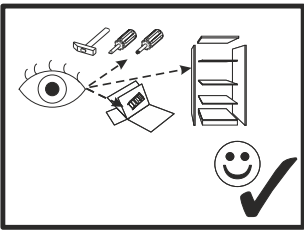

D: ALLGEMEINE HINWEISE FÜR MÖBEL AUS HOLZ UND HOLZWERKSTOFFE: MELAMIN, LAMINAT, ARMATURENBRETT
Zu reinigen, verwenden Sie ein feuchtes Tuch. Verwenden Sie nur Wasser oder ein mildes Reinigungsmittel. Wischen Sie mit einem Tuch trocken.

GB: GENERAL INSTRUCTIONS FOR FURNITURE OF WOOD AND WOOD MATERIALS: MELAMINE, LAMINATE, DASHBOARD
To clean, use a damp cloth. Use only water or a mild detergent. Wipe dry with a cloth.

ES: INSTRUCCIONES GENERALES PARA MUEBLES DE MADERA Y MATERIALES: MELAMINA, LAMINADO, TABLERO DE INSTRUMENTOS
Para limpiar, utilice un paño húmedo. Utilice sólo agua o un detergente suave. Seque con un paño

FR: INSTRUCTIONS GENERALES DE MEUBLES DE MATÉRIAUX DE BOIS ET: MÉLAMINÉS, STRATIFIÉS, TABLEAU DE BORD
Pour nettoyer, utilisez un chiffon humide. d'eau ou d'un détergent doux. Essuyer avec un chiffon.

CZ: VŠEOBECNÉ POKYNY PRO NÁBYTEK ZE DŘEVA A DŘEVĚNÝCH MATERIÁLŮ: MELAMINE, LAMINÁT, DASHBOARD
K čištění použijte vlhký hadřík. Používejte pouze vodu nebo jemným čistícím prostředkem. Vytřete do sucha hadříkem.

PL: OGÓLNE INSTRUKCJE DOTYCZĄCE MEBLI Z DREWNA ORAZ MATERIAŁÓW DREWNOPOCHODNYCH: MELAMINA, LAMINAT, OKLEINA
Do czyszczenia należy używać wilgotnej ściereczki. używać wyłącznie wody lub delikatnego detergentu. Wycierać do sucha ściereczką.

HU: A BÚTOR ÁLTALÁNOS FAANYAGOK ÉS FAIPARI ANYAGOK: MELAMIN, LAMINÁT, MŰSZERFAL
A tisztításhoz használjon egy nedves ruhával. Csak vizet vagy enyhe tisztítószerrel. Töröld szárazra egy ronggyal.

HU: A BÚTOR ÁLTALÁNOS FAANYAGOK ÉS FAIPARI ANYAGOK: MELAMIN, LAMINÁT, MŰSZERFAL
A tisztításhoz használjon egy nedves ruhával. Csak vizet vagy enyhe tisztítószerrel. Töröld szárazra egy ronggyal.

SK: VŠEOBECNÉ POKYNY PRO NÁBYTEK ZE DŘEVA A DŘEVĚNÝCH MATERIÁLŮ: MELAMINE, LAMINÁT, DASHBOARD
Na čistenie použite vlhkú handričku. používajte iba vodu alebo jemným čistiacim prostriedkom. Vytrite dosucha handričkou.

RU: ОБЩИЕ ПРАВИЛА ДЛЯ МЕБЕЛИ ДРЕВЕСИНЫ И ДРЕВЕСНЫХ МАТЕРИАЛОВ: МЕЛАМИН, ЛАМИНАТ, ПАНЕЛЬ
Для очистки используйте влажную ткань. Используйте только воду или мягкое моющее средство. Протрите сухой тряпкой.

IT: ISTRUZIONI GENERALI PER MOBILI DI LEGNO E LEGNO MATERIALI: MELAMINICO, LAMINATO, CRUSCOTTO
Per la pulizia, utilizzare un panno umido. Utilizzare solo acqua o un detergente neutro. Asciugare con un panno.

RO: INSTRUCȚIUNI GENERALE DE MOBILIER DE LEMNOASA ?I MATERIALE LEMNOASE: PAL, LAMINAT, TABLOU DE BORD
Pentru a cură?a, folosi?i o carpa umeda. Folosi?i numai apa sau un detergent slab. Sterge cu o carpa.

TR: AHŞAP VE AHŞAP MALZEMELERIN MOBILYA İÇİN GENEL BİLGİLER: MELAMIN, LAMINAT, PANEL
Temizlemek için, nemli bir bez kullanın. Sadece su veya hafif bir deterjan kullanın. Bir bez ile kurulayın.

NL: ALGEMENE RICHTLIJNEN VOOR MEUBELEN VAN HOUT EN HOUTPRODUCTEN MATERIALEN: MELAMINE, LAMINAAT, DASHBOARD
Schoon te maken, gebruikt u een vochtige doek. Gebruik alleen water of een mild schoonmaakmiddel. Veeg met een doek droog.

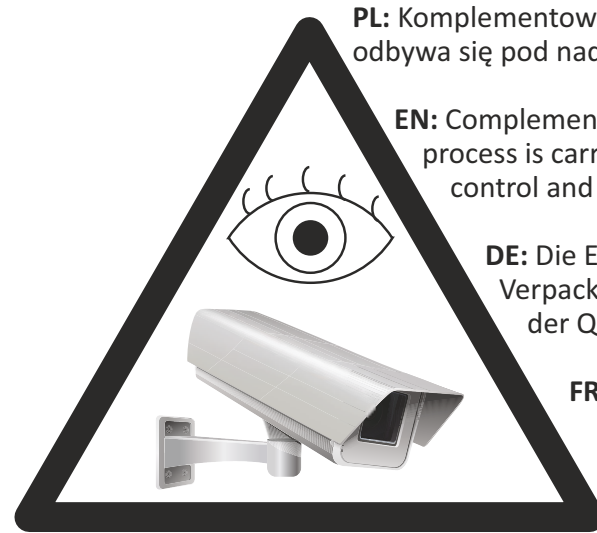
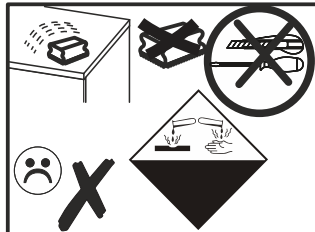
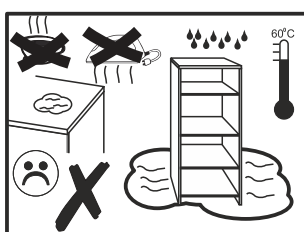
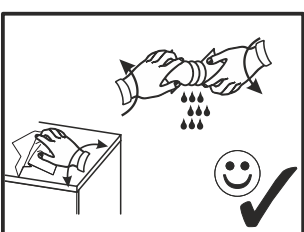
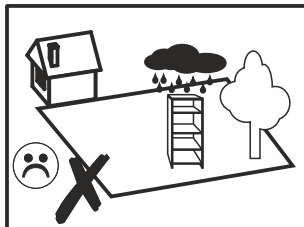
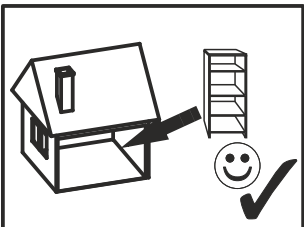
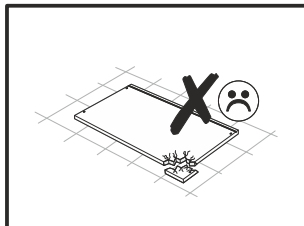
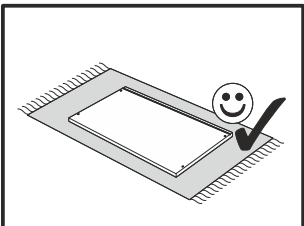
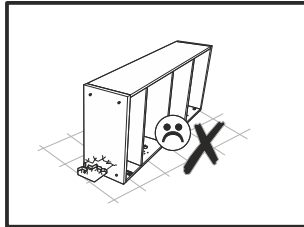
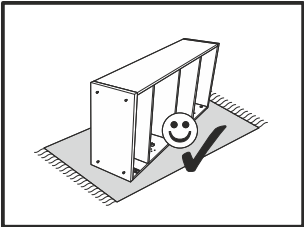
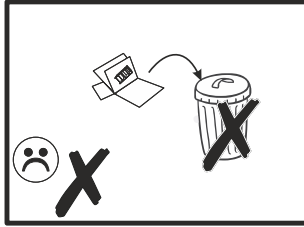
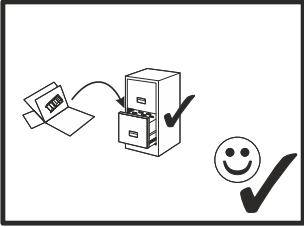

PL: Komplementowanie akcesorii oraz proces pakowania odbywa się pod nadzorem kontroli jakości oraz monitoringu.

EN: Complementing the accessories and the packaging process is carried out under the supervision of quality control and monitoring.

DE: Die Ergänzung des Zubehörs und des Verpackungsprozesses erfolgt unter der Aufsicht der Qualitätskontrolle und -überwachung.

FR: Le complément des accessoires et du processus d'emballage s'effectue sous la supervision d'un contrôle et d'une surveillance de la qualité.

PL - UWAGA!

Nasze powierzchnie o wysokim połysku są fabrycznie ochronione specjalną folią ochronną. Prosimy pozostawić ją na meblach do momentu zmontowania i usunięcia kurzu. Po usunięciu folii ochronnej pozostawić folię połyskową przez 12 godzin w pomieszczeniu do stwardnienia.

EN - ATTENTION!

Our high gloss surfaces have a protective foil when delivered. Please leave this foil on the furniture until it is completely assembled and all dust has been removed. Expose the high gloss foil to the room air for 12 hours to allow it to harden after removing the protective foil.

DE - HINWEIS!

Unsere Hochglanzoberflächen sind bei der Auslieferung durch eine Schutzfolie geschützt. Belassen Sie diese auf dem Möbel, bis es vollständig montiert und von Staub befreit ist. Der Hochglanzfolie nach der Entfernung der Schutzfolie 12 Stunden Zeit zum Nachhärten an der Raum-Luft geben.

CZ - POZOR!

Naše povrchy s vysokým leskem jsou při dodání chráněny ochrannou fólií. Ponechejte ji na nábytku, dokud nebude kompletně smontovaný a nebude z něho odstraněn prach. Po odstranění folie dejte nábytku 12 hodin čas na vytvrzení v pokojové teplotě.

SK - POZOR!

Naše vysoko lesklé povrchy sú chránené špeciálnou ochrannou fóliou. Prosím, nechajte ju na nábytku, kým nábytok nezmontujete a neodstránite prach. Po odstránení ochrannej fólie nechajte lesklý film 12 hodín v miestnosti vytvrdnúť.

HU - FIGYELEM!

Az általunk gyártott bútorok magas fényű felületei speciális védőfóliával gyárilag védettek. Kérjük a védő fóliát ne távolítsák el a bútor összeszereléséig, és a por szerelést követő eltávolításáig. A védőfólia eltávolítását követően tartsuk a bútort 12 órán át a fóliázott felületek megkeményedésére alkalmas környezetben.

HR - PAŽNJA!

Dijelovi namještaja u visokom sjaju imaju na sebi zaštitnu foliju prilikom isporuke. Molimo vas da tu foliju ostavite na namještaju dok nije u potpunosti montiran i dok nije odstranjena sva prašina u prostoru. Nakon uklanjanja zaštitne folije dijelove namještaja u visokom sjaju izložiti sobnom zraku 12 sati.

FR - ATTENTION!

Nos surfaces très brillantes ont une feuille protectrice à la livraison. Veuillez laisser cette feuille sur le meuble jusqu'à ce qu'il soit complètement assemblé et que toute la poussière ait été enlevée. Exposer la surface très brillante à l'air ambiant pendant 12 heures pour lui permettre de durcir après avoir retiré la feuille de protection.

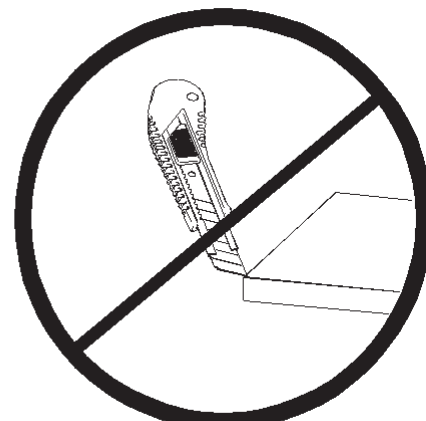
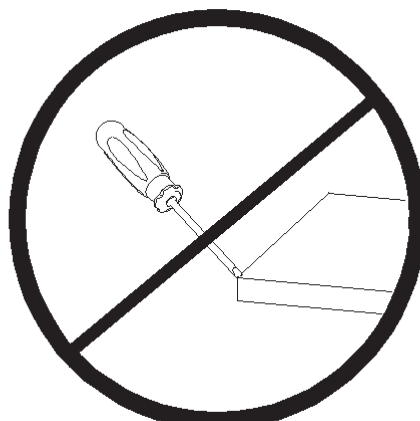
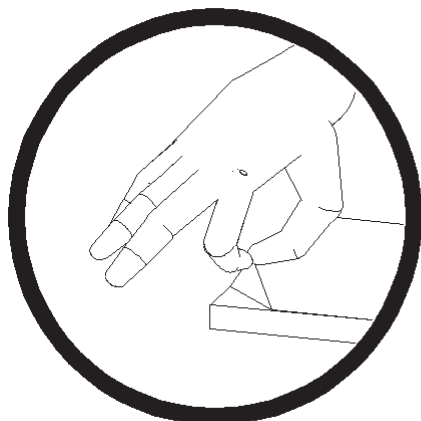

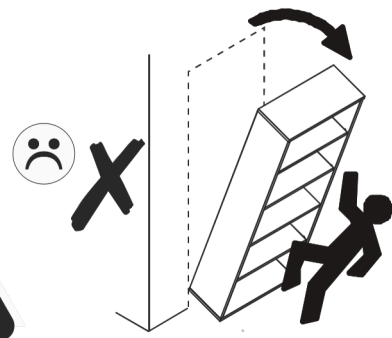
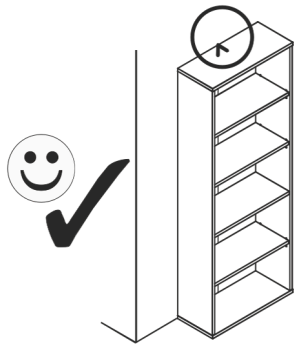

PL.
UWAGA! Mebel należy trwale zamocować do ściany, aby uniknąć ryzyka związanego z przewróceniem się mebla. W paczce nie ma śrub mocujących, ponieważ rodzaj mocowania należy odpowiednio dobrać do rodzaju ściany. Dobierz właściwie do Twojego rodzaju ściany.

SK.
POZOR! Nábytok musí byť trvalo pripevnený k stene tak, aby sa zamedzilo riziku prevrátenia. Balík neobsahuje upevňovacie skrutky, pretože typ upevnenia je treba vybrať podľa typu steny. Vyberte typ vhodný pre Vašu stenu.

FR.
ATTENTION! Ce meuble doit être fixé en permanence au mur pour éviter les risques de chute. Les vis de fixation ne sont pas livrées car le type de fixation doit être choisi en fonction du type de mur. Sélectionnez les fixations adaptées au mur.

D.
ACHTUNG! Um alle mit dem Umkippen des Möbels verbundenen Risiken auszuschließen, muss das Möbel fest an der Wand verankert werden. Beschläge für die Wandbefestigung sind nicht beige packt, da diese von der jeweiligen Wandbeschaffenheit abhängig sind. Bitte solche Befestigungsschläge wählen, die für die heimischen Wände geeignet sind.

EN.
WARNING! To prevent this furniture from tripping over, fix it to the wall permanently. Fixing devices are not included since different wall materials require different types of fixing devices. Please make sure you chose the correct ones for your type of wall.

I.
ATTENZIONE! Il mobile deve essere permanentemente fissato alla parete per evitare i rischi derivanti da un ribaltamento del mobile. La confezione non include le viti di fissaggio, in quanto il tipo di fissaggio deve essere scelto in base al tipo di parete. Utilizzare viti appropriate in base al materiale della parete.

SLO.
POZOR! Pohoštvo trajno pritrđite na steno, da preprečite tveganje, da se prevrne. V paketu ni pritrđilnih vijakov, saj je treba način pritrđitve ustrezno izbrati glede na vrsto stene. Izberite način, ki je ustrezen za vašo steno.

RU.
ПРИМЕЧАНИЕ! Эту мебель необходимо всегда прикреплять к стене, чтобы избежать рисков, связанных с переворотом мебели. В пакете нет крепежных винтов, потому что тип крепления должен быть выбран в соответствии с типом стены. Выберите, пожалуйста, правильные винты к вашей стене.

CZ.
POZOR! Nábytek je nutné pevně připravit ke zdi, abychom se vyhnuli riziku spojenému s jeho převrnutím. Součástí balení nejsou upevňovací šrouby, protože způsoby připravení je nutné zvolit podle druhu stěny. Vyberte správný pro Vaš typ stěny

CN.
注意 本家具需要固定在墙上以免倒塌。箱子里没有安装螺钉。因为安装方式需要根据墙的类型调整。请按照您的墙类型选择合适的安装方式。

HU.
FIGYELEM! Rögzítse a bútorokat a falhoz, hogy elkerülje a bútor felborulásának kockázatát. A készletben nem találhatók rögzítőcsavarok, mivel a rögzítés típusa a fal típusától függ. Válassza ki a fal típusának megfelelő kötőelemeket

HR.
NAPOMENA! Namještaj mora biti trajno pričvršćen za zid, kako bi se izbjegao rizik od njegova prevrtanja. U paketu nema vijaka za pričvršćivanje, jer se vrsta montaže mora prilagoditi vrsti zida. Odaberite pravu vrstu prema Vašoj vrsti zida.

E.
¡ATENCIÓN! El mueble debe ser fijado permanentemente a la pared para evitar el riesgo relacionado con el vuelco del mueble. En el paquete no hay tornillos de fijación, ya que se debe elegir el tipo de fijación adecuado para el tipo de pared. Elija el apropiado para su tipo de pared.

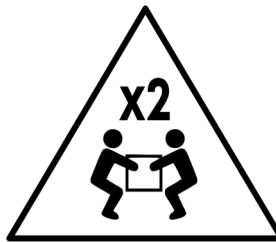

Producent:

Cama Meble Sp. z o.o.
ul. Jastrzębia 16
87-301 Kominy
Polska
gpsr@camameble.pl

