

Instrukcja montażu stołu

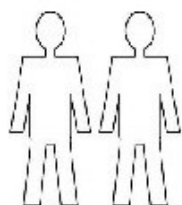

Montaż wykonuj zawsze w dwie osoby !

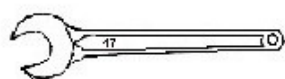

Potrzebne narzędzia !

Klucz 17 (opakowanie nie zawiera klucza)



Uwaga !

Po otwarciu opakowania umieść stół do góry nogami na opakowaniu, aby uniknąć uszkodzenia blatu podczas montażu

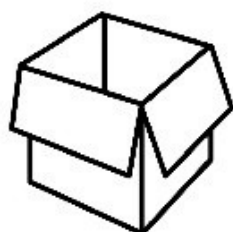

Opakowanie zawiera

1. Błat stołu - 1 sztuka
2. Nogi do stołu - 4 sztuki
3. Nakrętka  (M10) - 8 sztuk

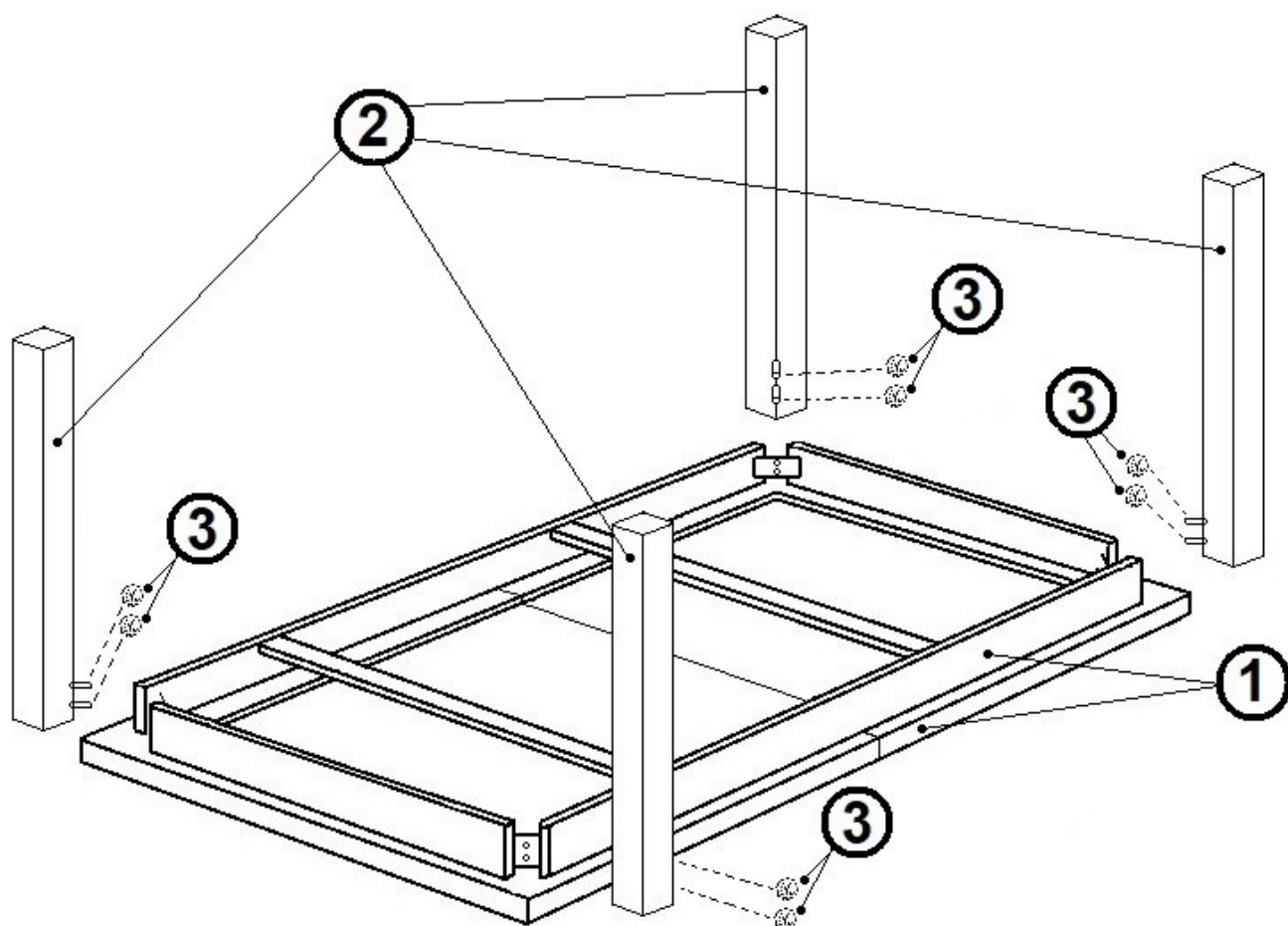
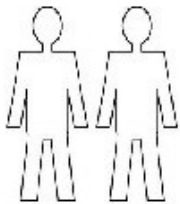

Table assembly instructions



Always perform the assembly by two people !



Tools needed !

Wrench 17 (the package does not include the wrench)



Attention !

After opening the package, place the table upside down on the package to avoid damaging the table top during assembly

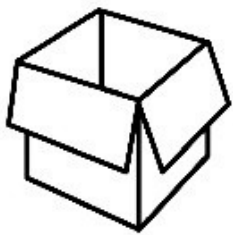

The package contains

1. Table top - 1 piece
2. Table legs - 4 pieces
3. Nut  (M10) - 8 pieces

