

MEMONE R1D1SZ

PL> INSTRUKCJA MONTAŻU
D >MONTAGEANLEITUNG
GB>ASSEMBLY INSTRUCTIONS

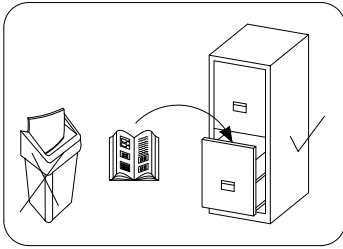

Czas montażu
 Montagezeit
 Time to assemble

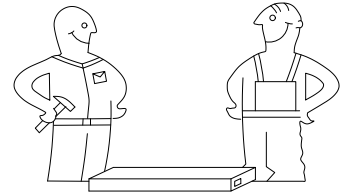
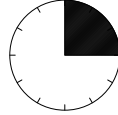

1 hours
 1 zeit
 1 godz.

Tools required narzędzia wymagane Werkzeuge erforderlich

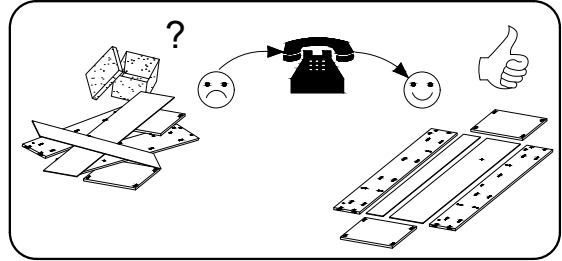
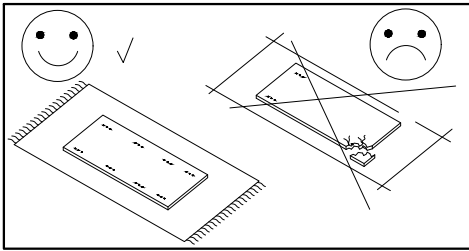
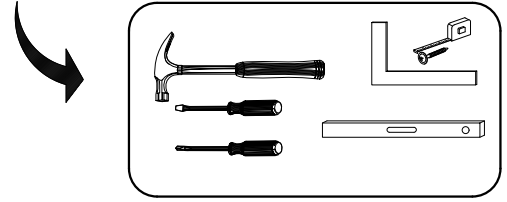

Uwaga / Achtung / Caution

PL>Czyszczenie należy wykonać wyłącznie za pomocą ściereczki lub lekko nawilżonego ręcznika.
 Nie stosować środków czyszczących do szorowania.

Szanowny kliencie, jeśli podczas montażu stwierdzisz uszkodzenie lub brak części, proszę podaj jej kod alfanumeryczny lub zaznacz ją na instrukcji montażu i prześlij wraz z protokołem reklamacyjnym

D >Bitte nur mit einem Staubtuch oder leicht feuchtem Lappen reinigen. Keine scheuerenden Putzmittel verwenden.

Sehr geehrter kunde, sollte ein teil fehlen oder beschädigt sein, kreuzen sie dies bitte deutlich auf der montageanleitung an und schicken sie die montageanleitung mit ein.

GB>Please only clean with a duster or a damp cloth. Do not use any abrasive cleaners.

Dear customer, should there be any piece missing or damaged, kindly mark this piece clearly on the attached assembly instructions and return them to us.

Karta serwisowa /Service Karte /Service card

AKCESORIA / ZUBEHÖR / ACCESSORIES

8.0x35 D 38	 M3 4	 A 34	 B 34	3.5x16 H 18	 I 12	M4.0x12 V2 32	 S 16	 L 3	"0" Z 3
 X 34	 X 2	 V1 16	L-350 mm R 1		3.0x20 H3 5	 T1 7			

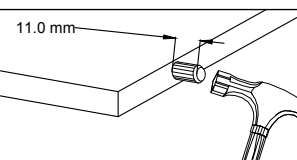
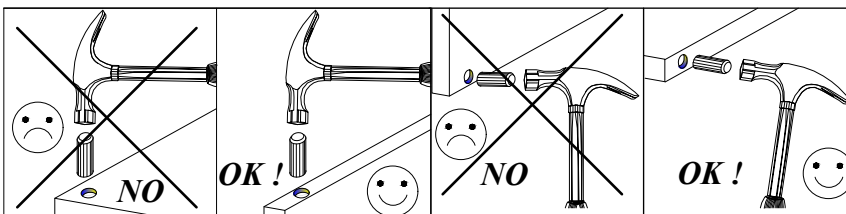

No.	Pcs.	L	W	D	Pac
1	1	600	400	22	1/1
2	1	600	400	22	1/1
3	1	1805	380	16	1/1
4	1	1805	380	16	1/1
5	1	1550	344	16	1/1
6	1	568	344	16	1/1
7	3	344	276	16	1/1
8	4	344	276	16	1/1
9	1	1557	286	16	1/1
10	1	596	213	16	1/1
11	2	1819	291	3	1/1
12	1	568	60	16	1/1
13	1	1549	60	16	1/1
14	1	350	154	16	1/1
15	1	350	154	16	1/1
16	1	511	136	16	1/1
17	1	526	357	3	1/1

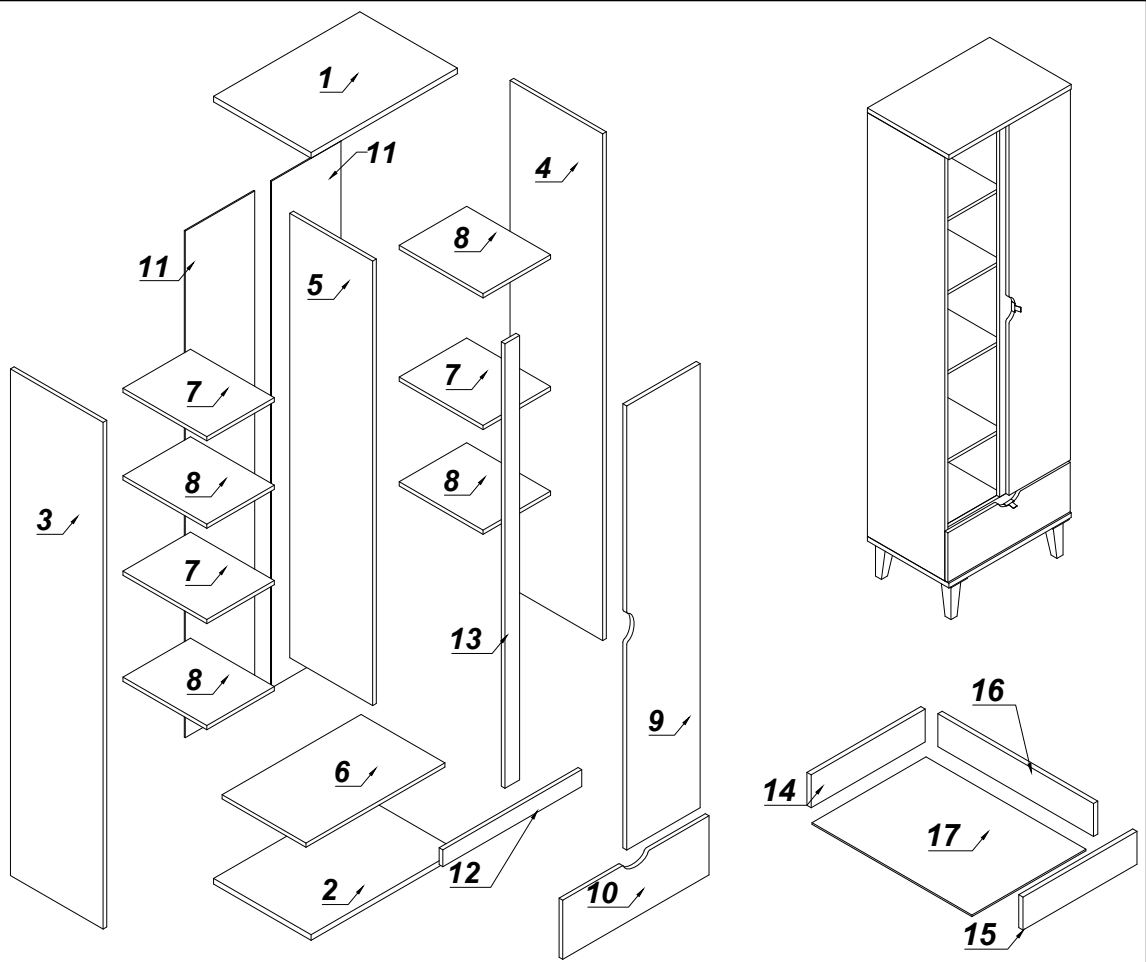

1

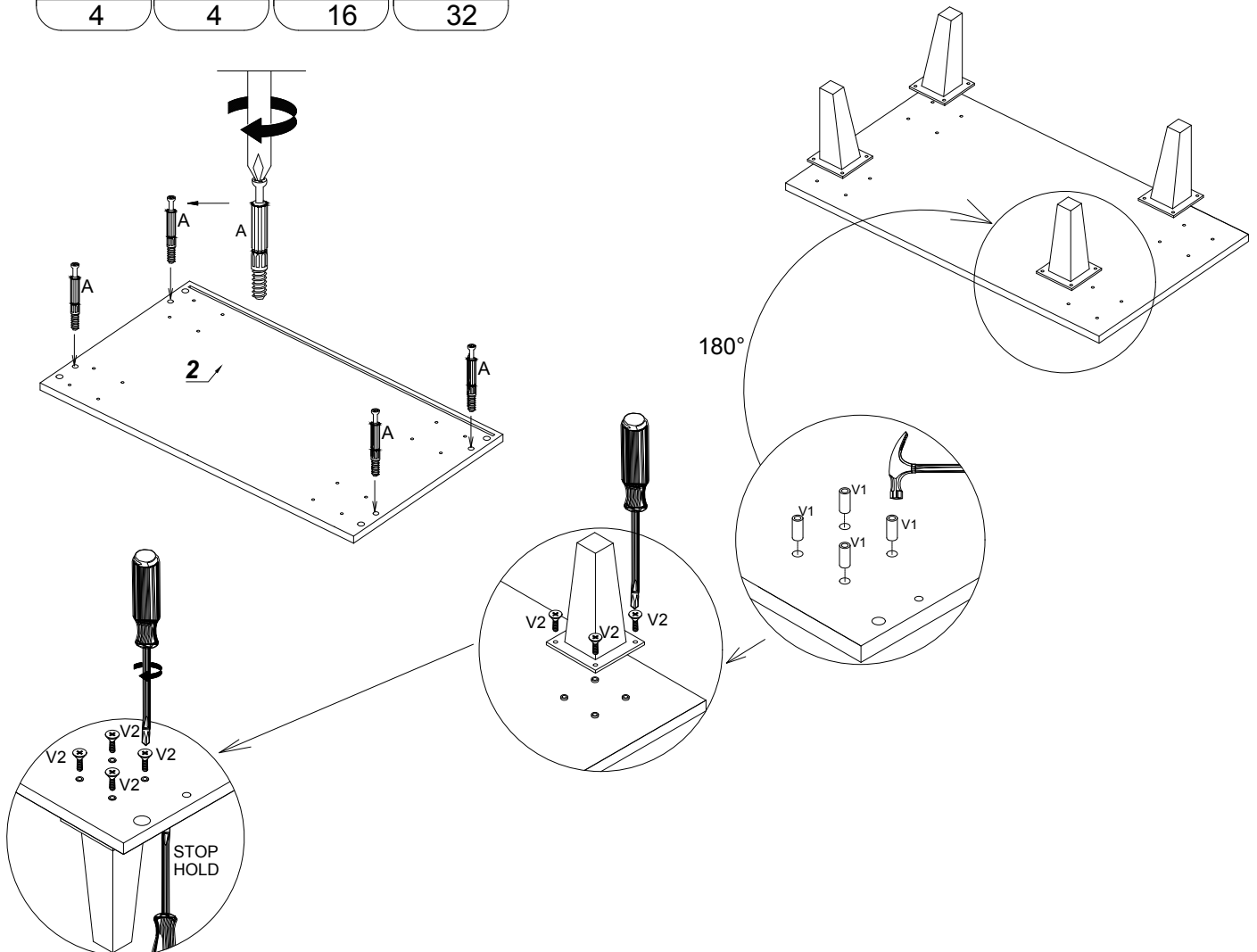
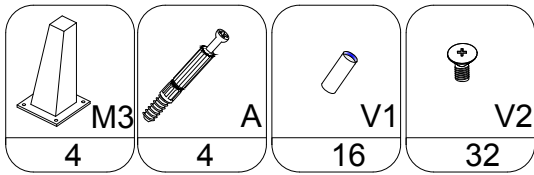

2

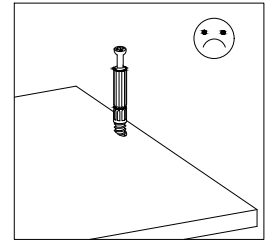
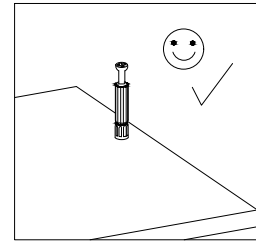
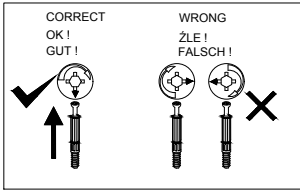
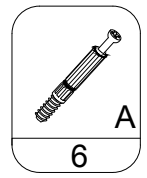
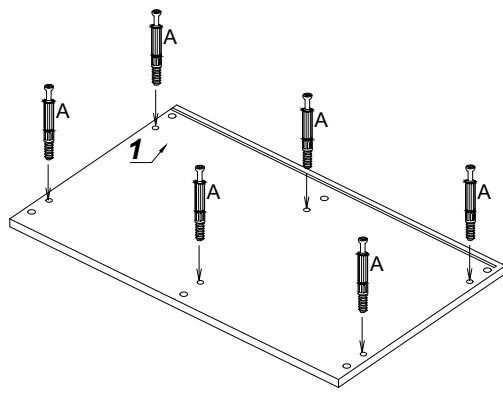

3

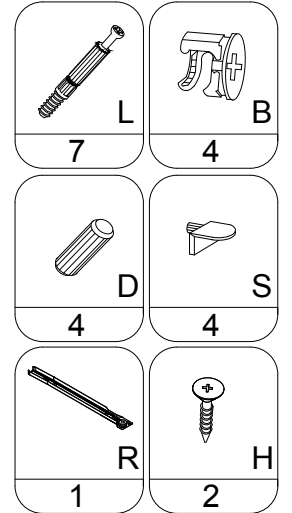
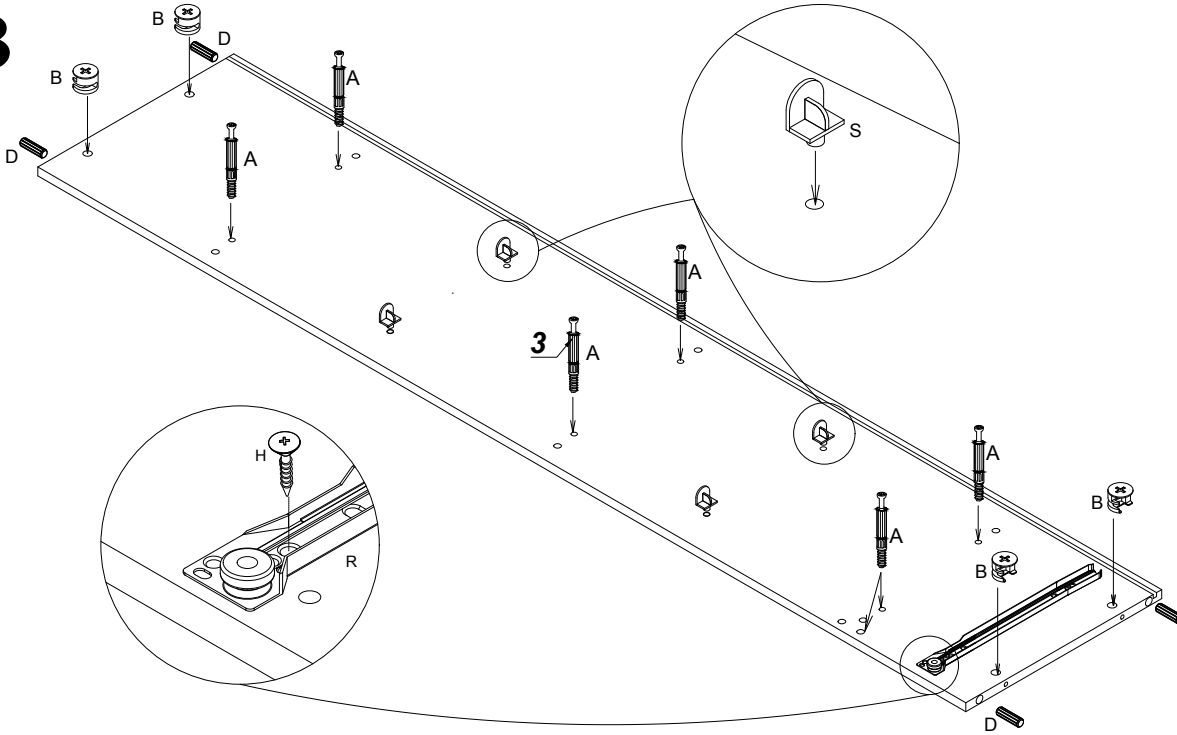

4

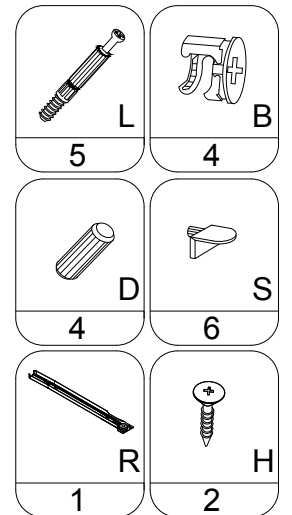
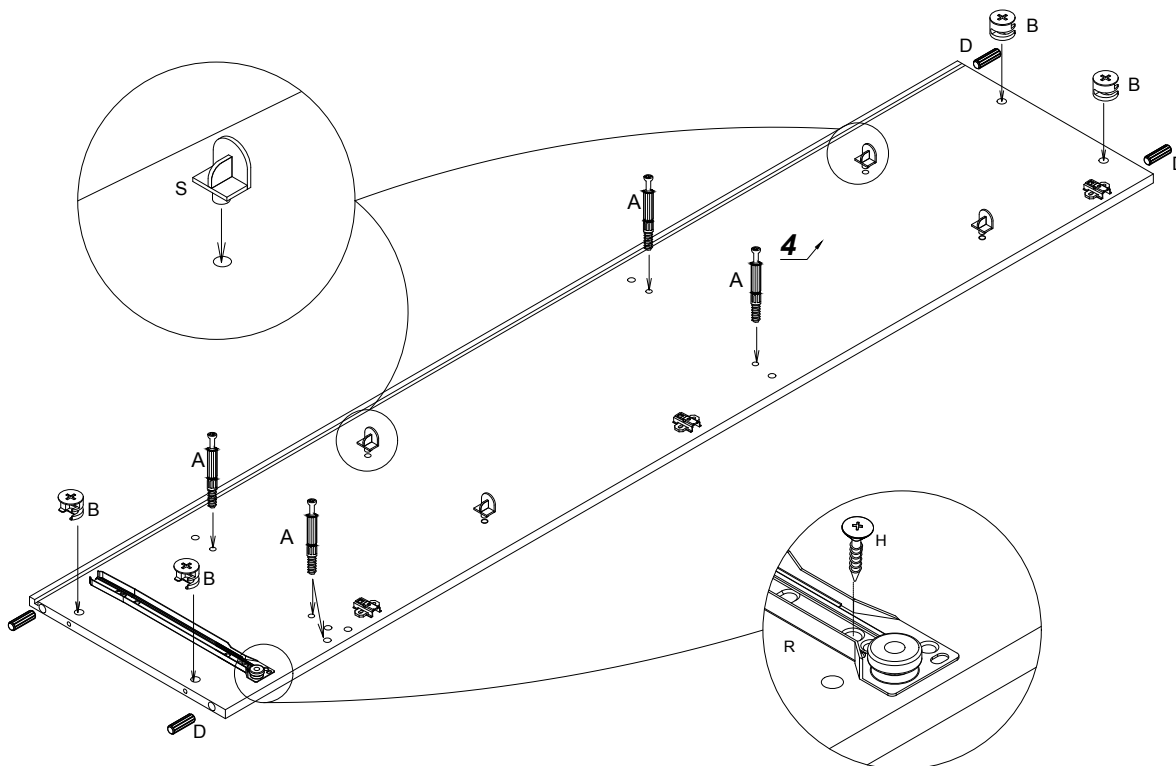

5

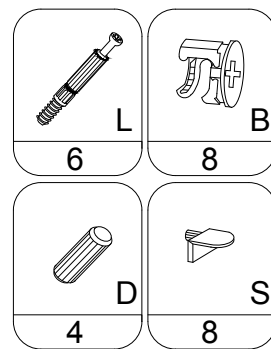
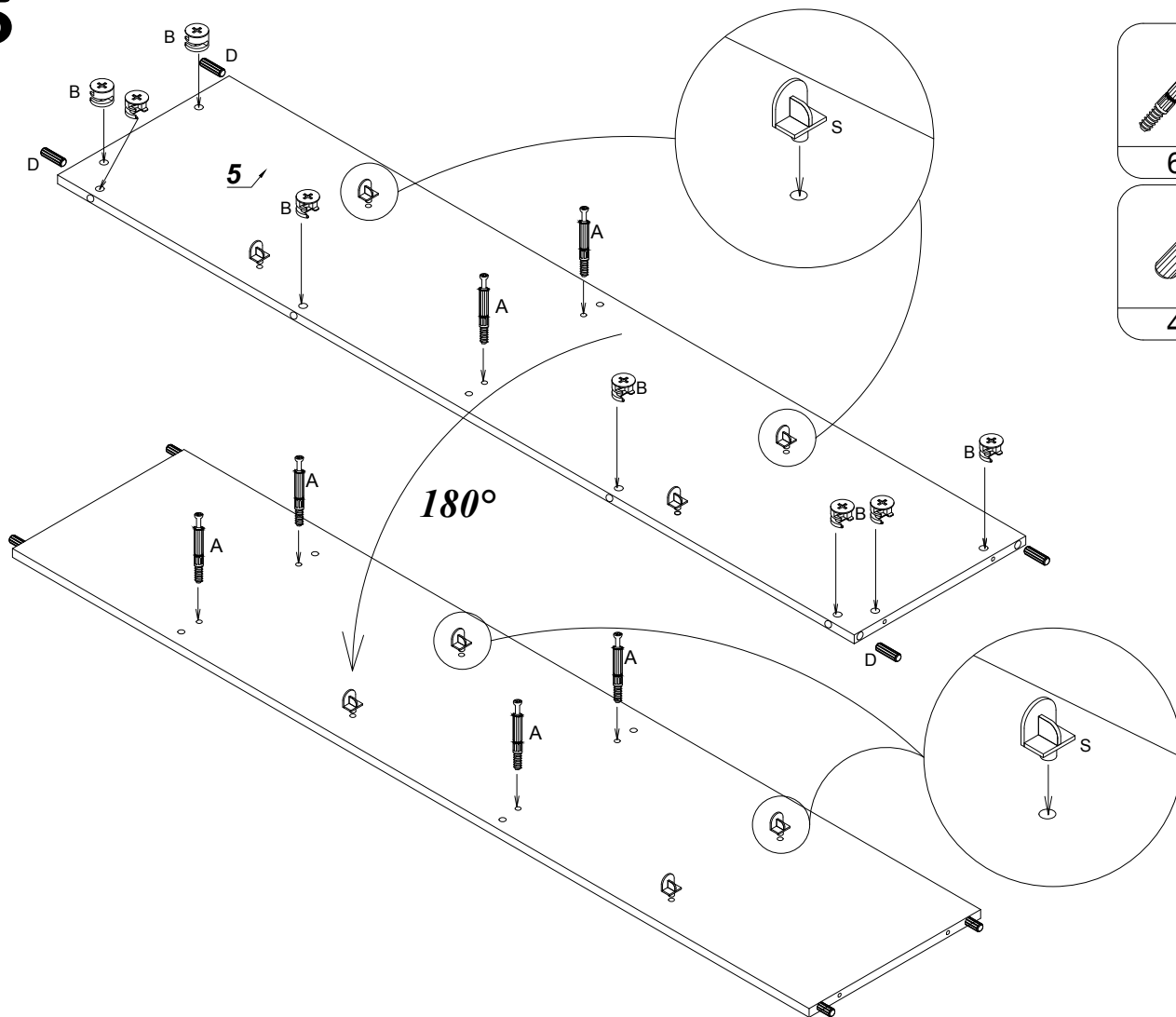

6

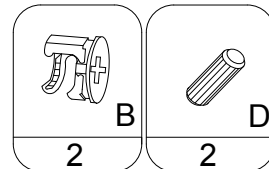
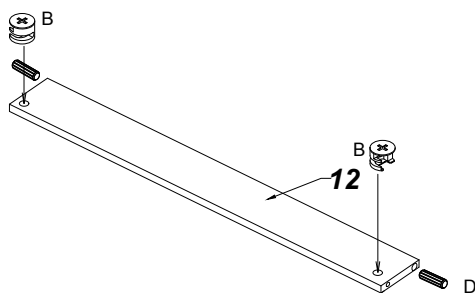

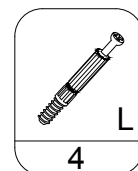
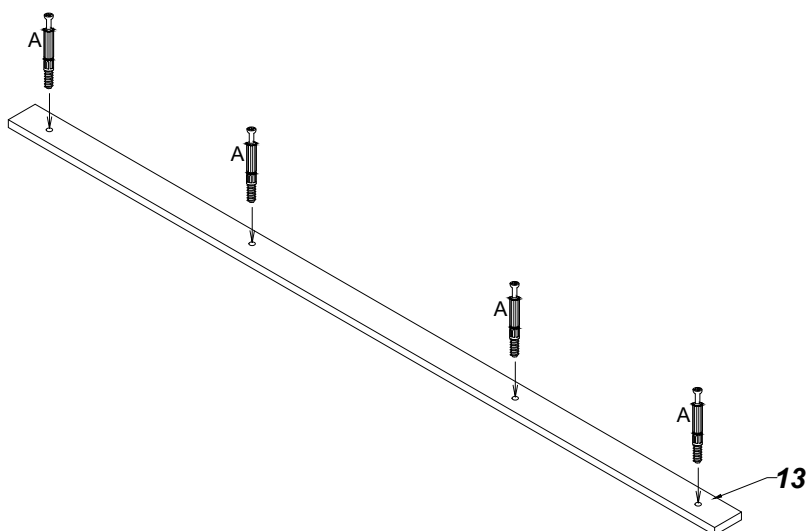

7



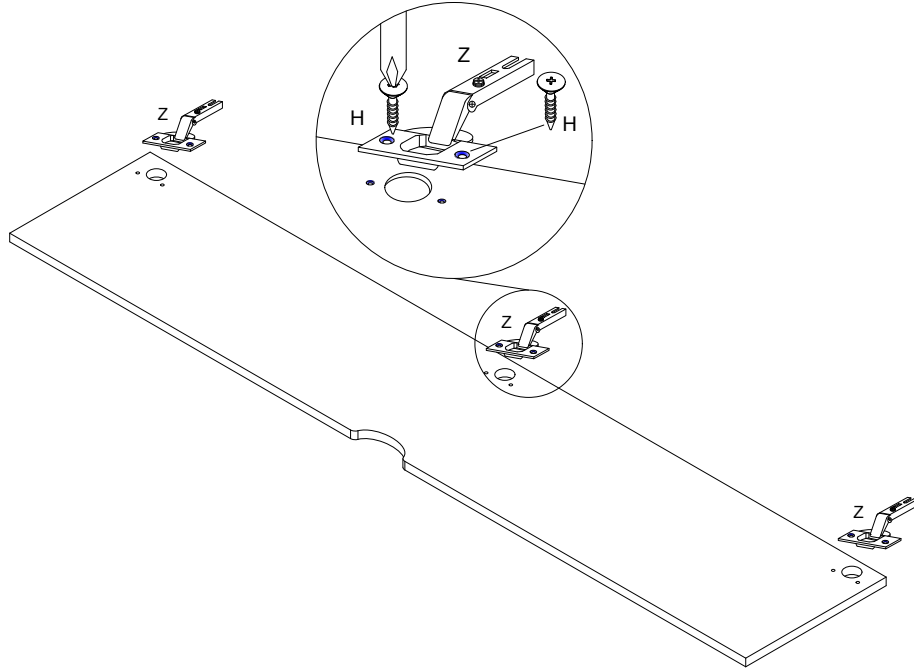



8

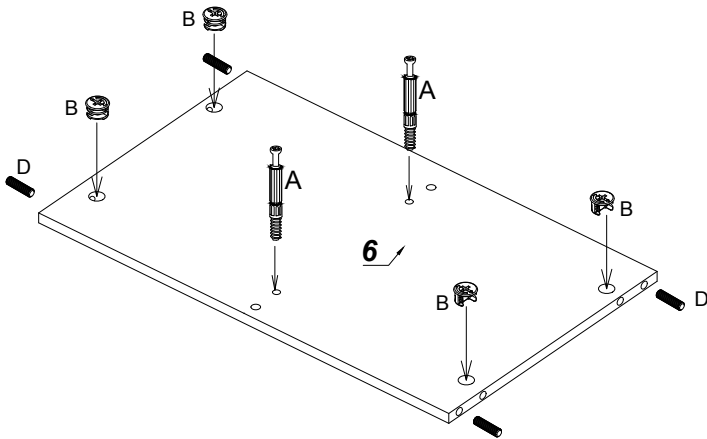

3.5x16 	"0" 
H	Z
6	3

9



	L
2	
	B
4	
	D
4	

10

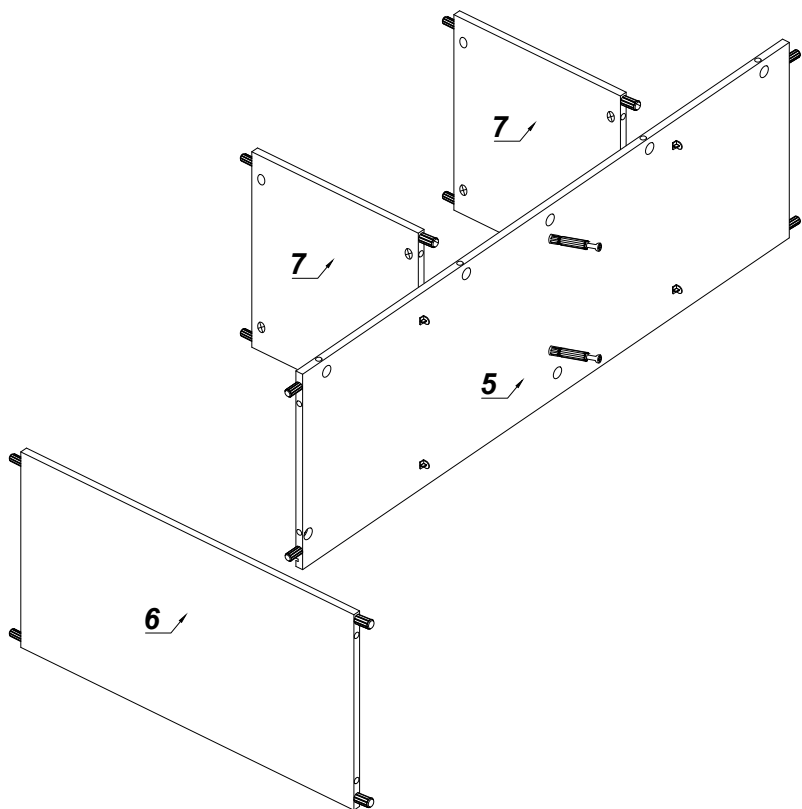

11

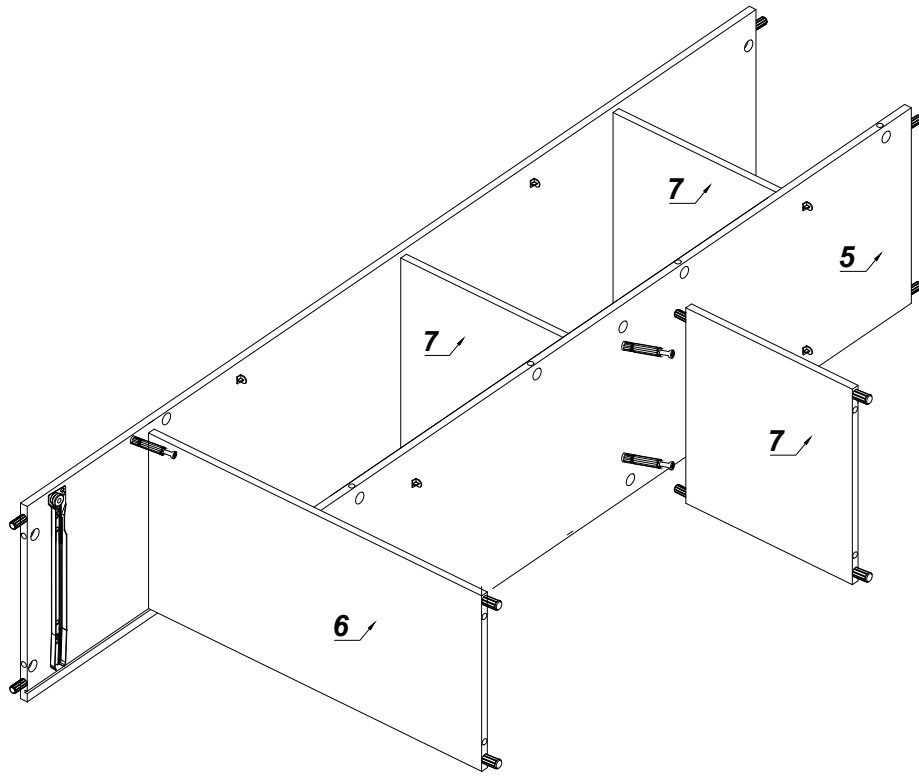

12

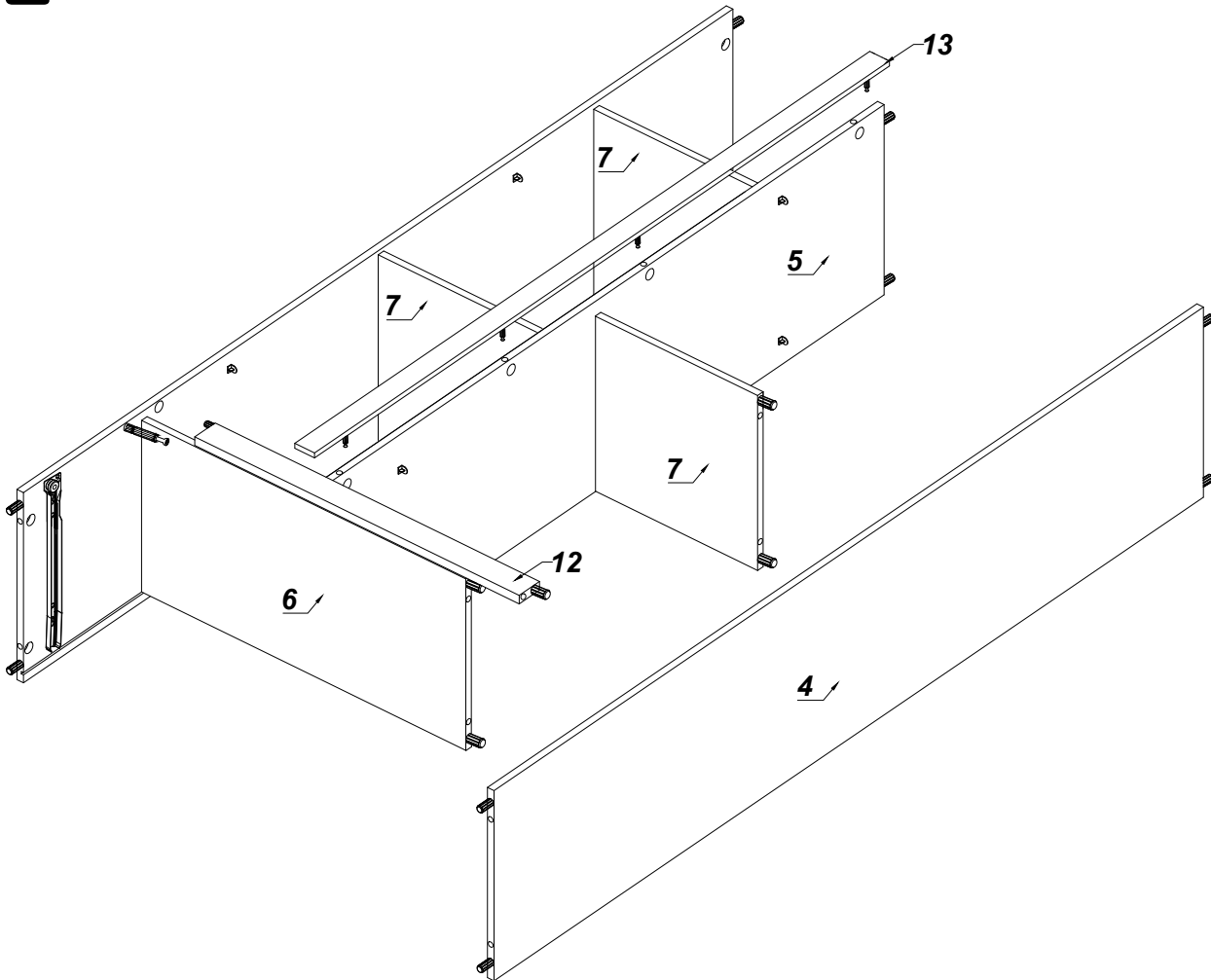

13

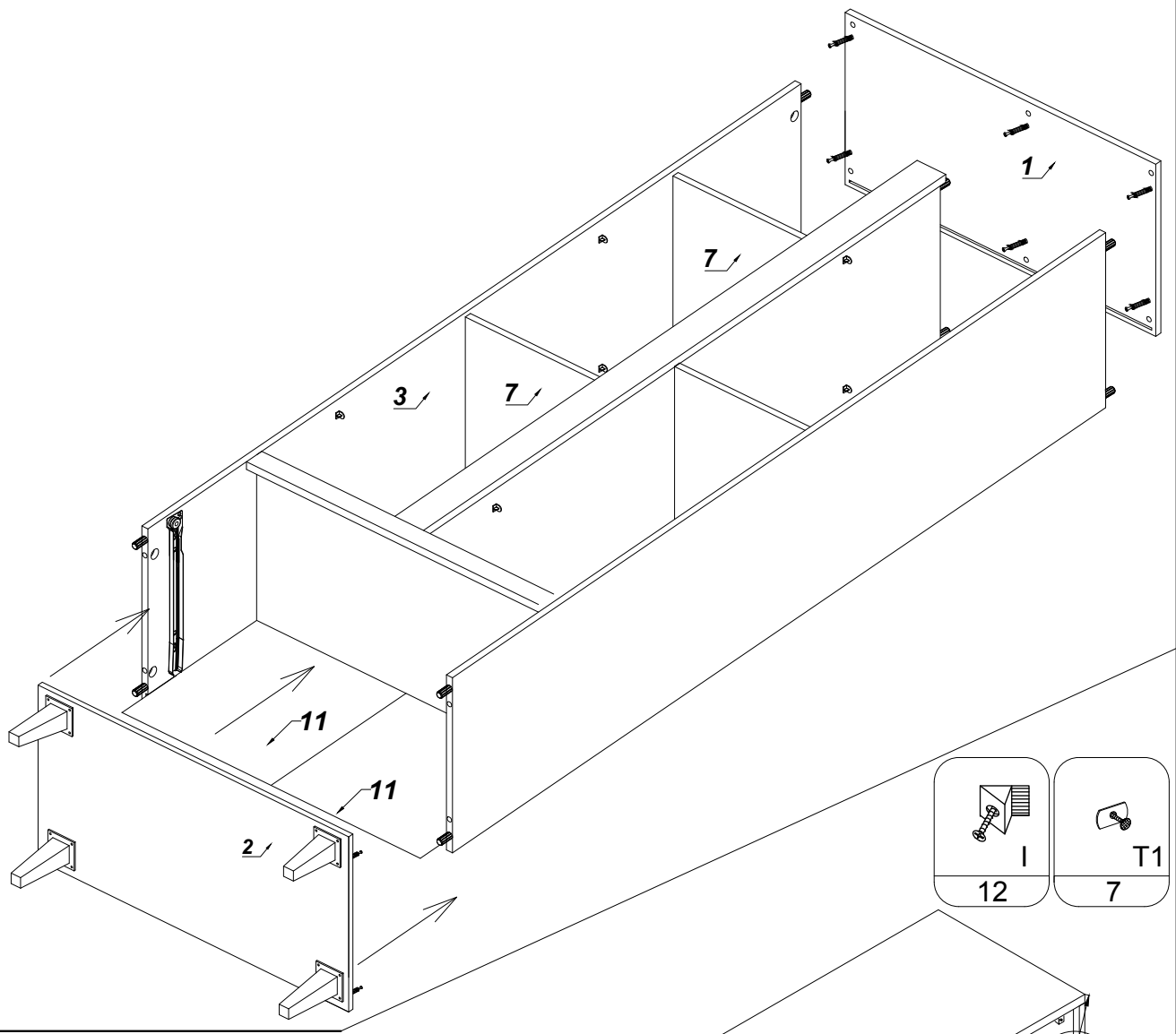

14

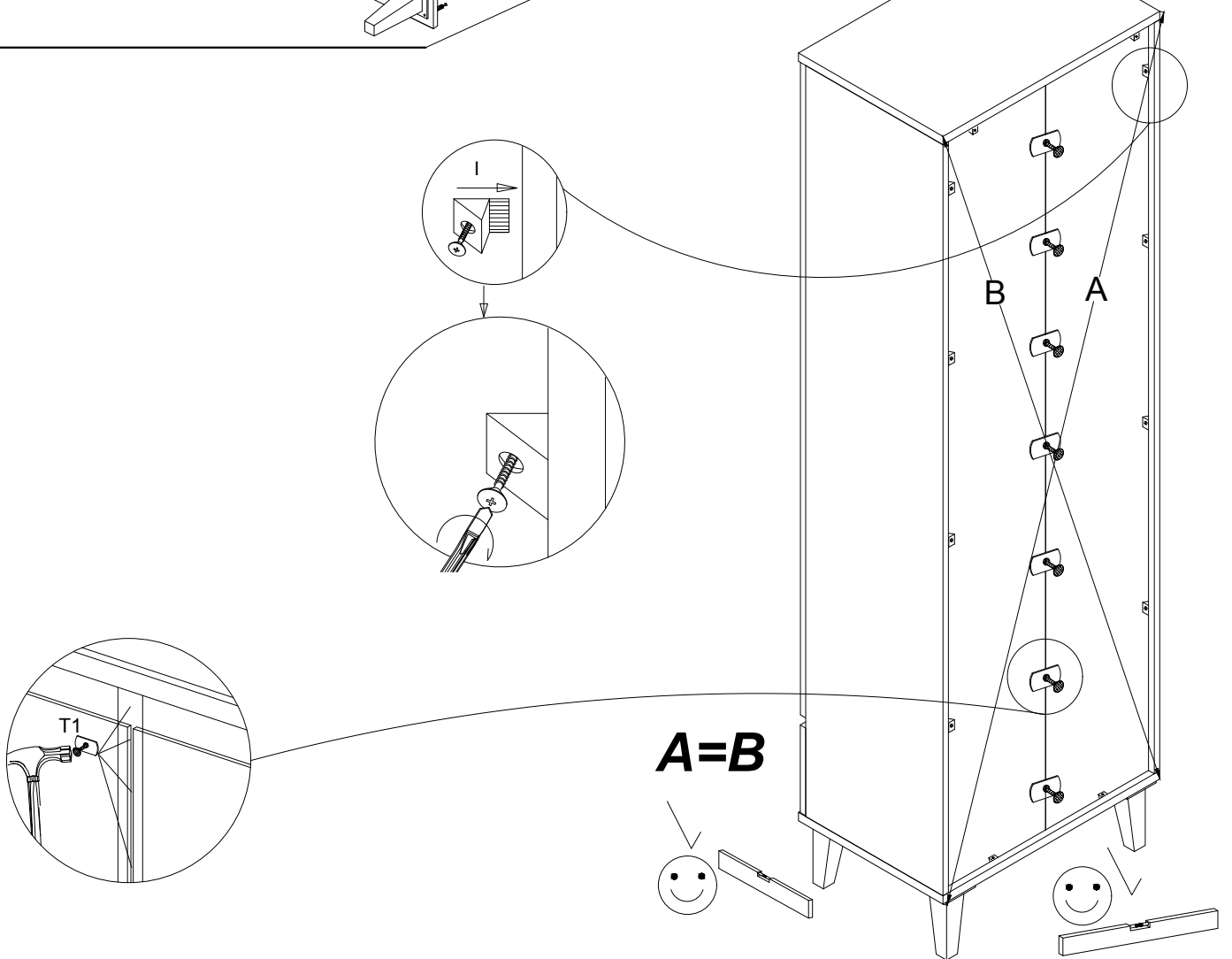

15

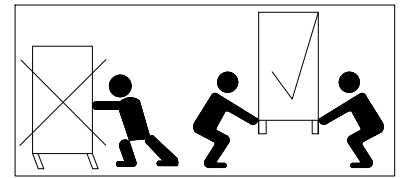
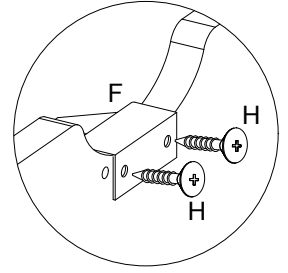
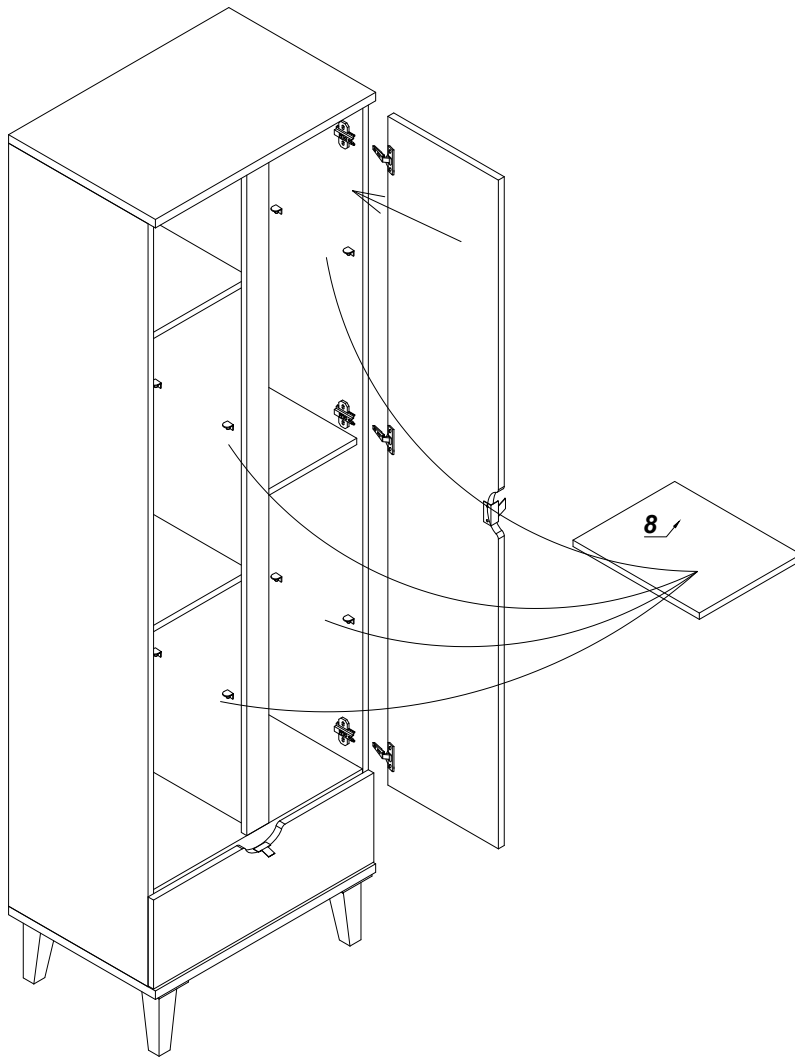

16

