

# TRIO 013

**PL** Instrukcja montażu

**CZ** Návod k montáži

**D** Montageanleitung

**GB** Assembly instruction

**F** Model d'emploi

**HU** Szerelési útmutató

**I** Istruzione di montaggio

**NL** Handleiding voor de montage

**RU** Инструкция по монтажу

**RO** Instrucțiuni de montare

**SK** Návod k montáži

**TR** Montaj talimatı

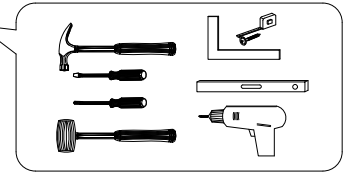
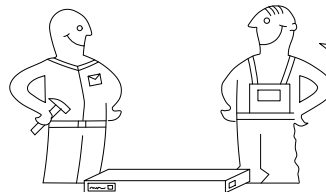

	<b>Uwaga • Upozornini • Achtung • Attention • Caution • Figyelem Attenzione • Opgelet • Внимание • Atentie • Upozornenie • Dikkat</b>
<b>PL</b>	Czyszczenie należy wykonać wyłącznie za pomocą ściereczki lub lekko nawilżonego ręcznika. Nie stosować środków czyszczących do szorowania.
<b>CZ</b>	Čistění je nutné vykonávat výhradně pomocí utěrky nebo lehce navlhčeného ručníku. Nepoužívejte čisticí prostředky obsahující abrazivní částice.
<b>D</b>	Bitte nur mit einem Staubtuch oder leicht feuchtem Lappen reinigen. Keine scheuernden Putzmittel verwenden.
<b>GB</b>	Please only clean with a duster or a damp cloth. Do not use any abrasive cleaners.
<b>F</b>	Le nettoyage se fait uniquement à l'aide d'un torchon ou d'une serviette légèrement mouillée.
<b>HU</b>	A tisztítás kizárólag törölrőruha vagy enyhén nedvesített törölköző segítségével végezhető. Súroló hatású tisztítószerket nem szabad használni.
<b>I</b>	Pulire esclusivamente con un panno o un asciugamano umido.
<b>NL</b>	Reinig alleen met een stofdoek of een lichtjes vochtige doek. Gebruik geen schurende poetsmiddelen.
<b>RU</b>	Очищайте от пыли тряпкой или слегка влажной ветошью. Не допускается применение чистящих средств, не предназначенных для ухода за мебелью.
<b>RO</b>	Curățarea trebuie efectuată numai cu o cârpă sau cu un prosop ușor umezit. Nu utilizați agenți de curățare abrazivi.
<b>SK</b>	Čistení je nutné vykonávať výhradne pomocí utierky alebo ľahko zvlhnutým ručníkom. Nepoužívajte čistiace prostriedky obsahujúce abrazívni častice.
<b>TR</b>	Lütfen sadece bir toz bezile veya hafif nemli yumuşak bir bezle siliniz. Aşındırıcı temizlik malzemeleri kullanmayınız.

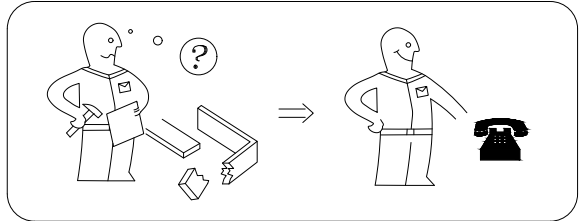
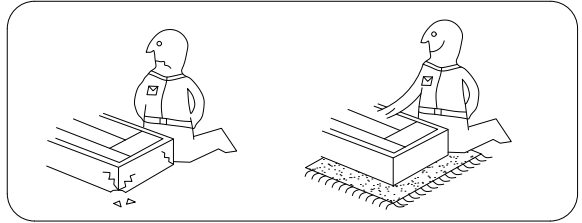

		8.0x30 		4.0x25 
A1	B	D	M1	G
12	24	50	5	5
O	B1	X1	X	
26	1	26	24	

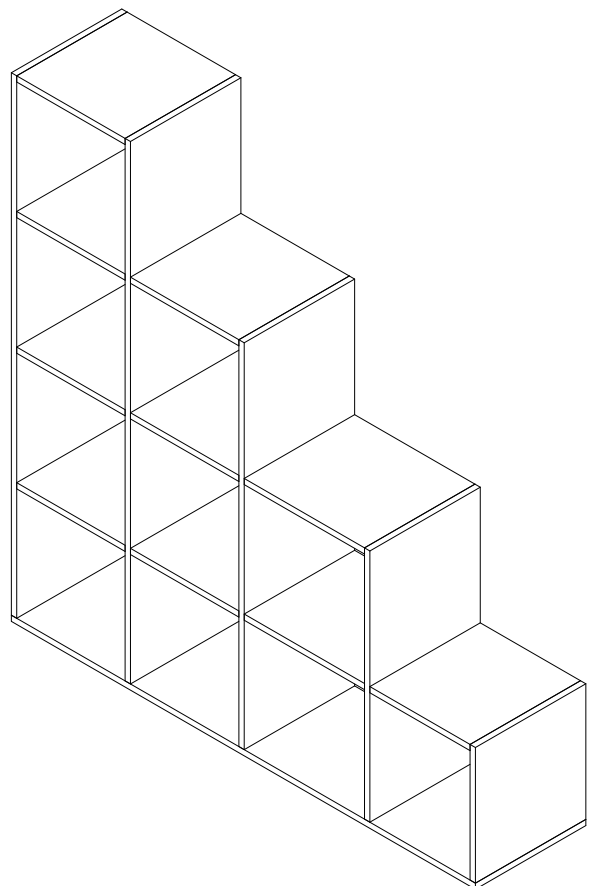

# TRIO 013

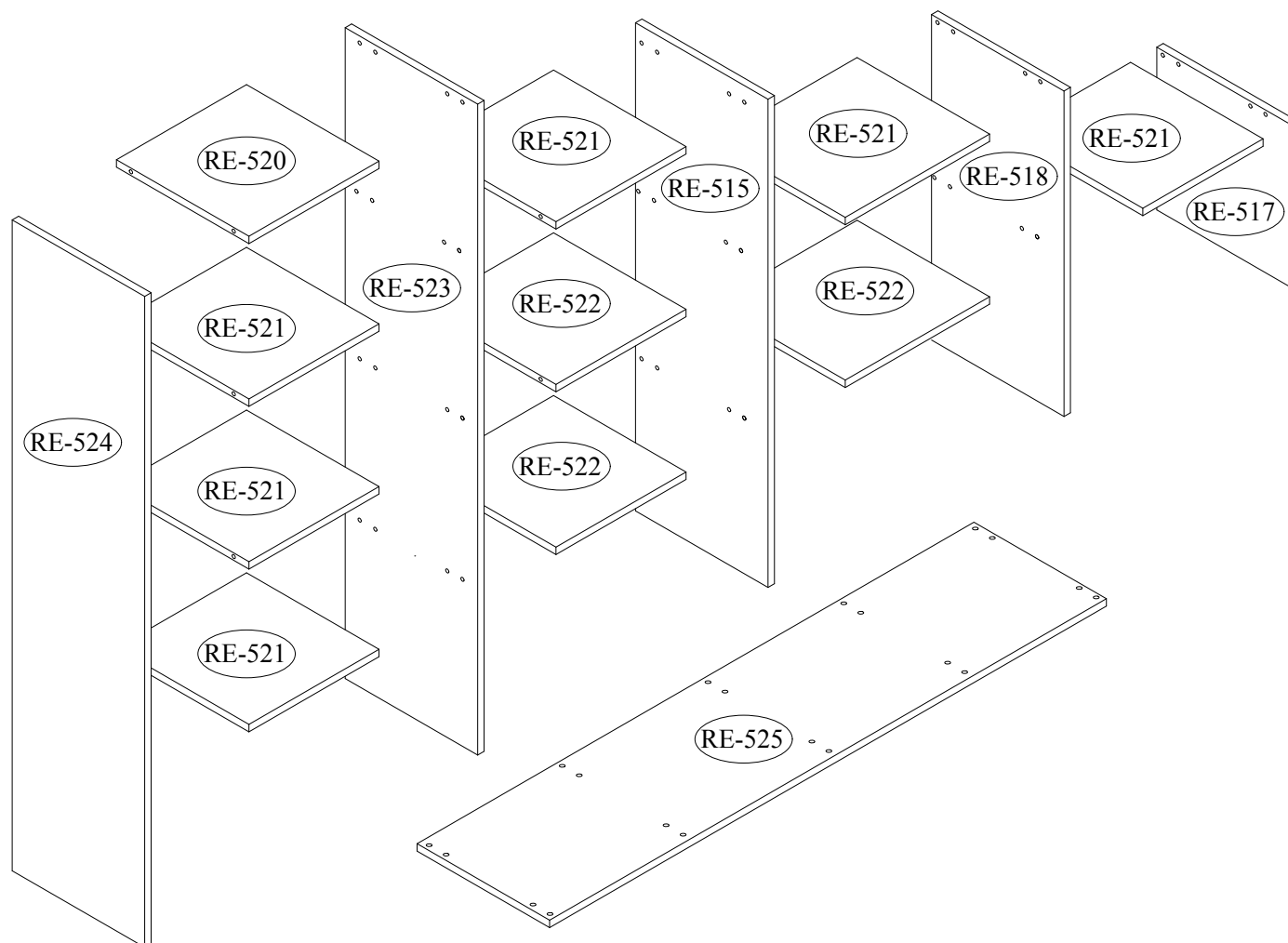
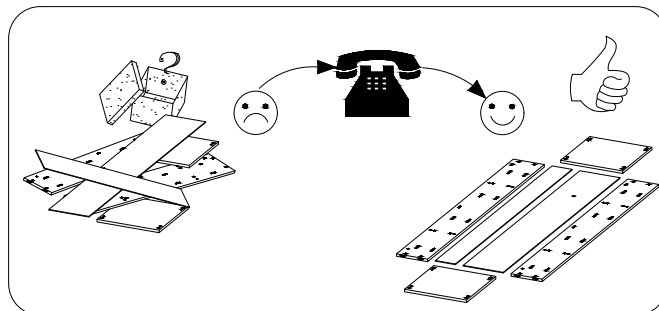
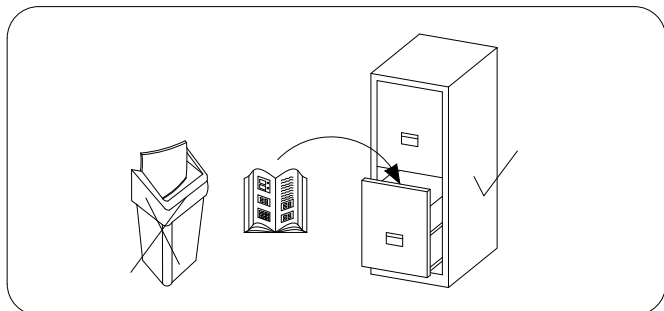

1

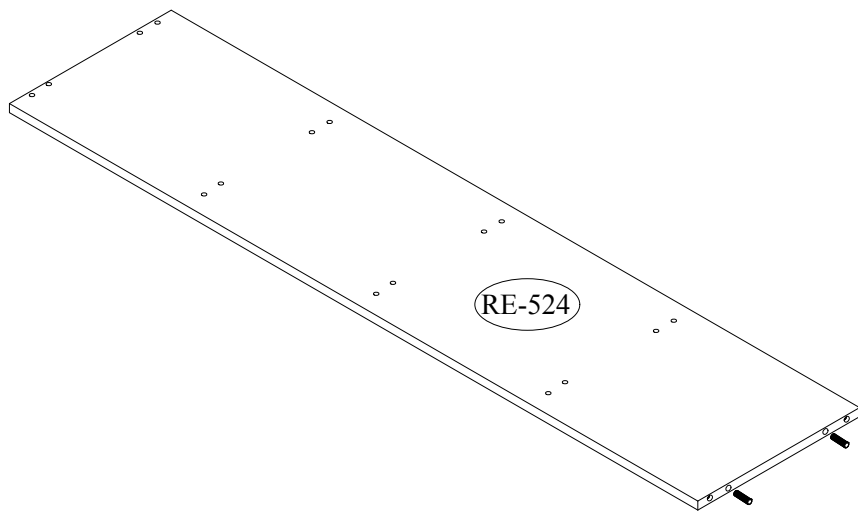

8.0x30

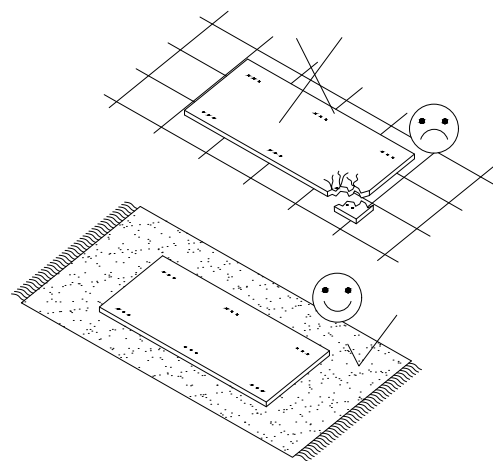
D
2



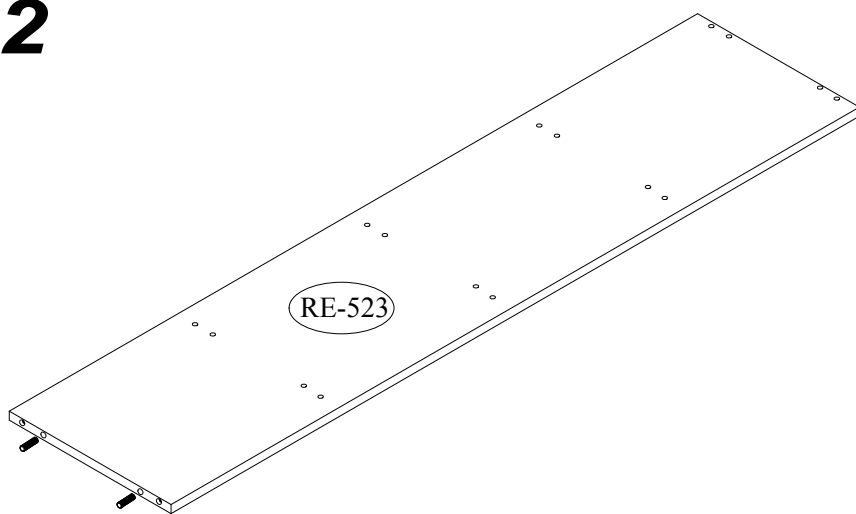

2

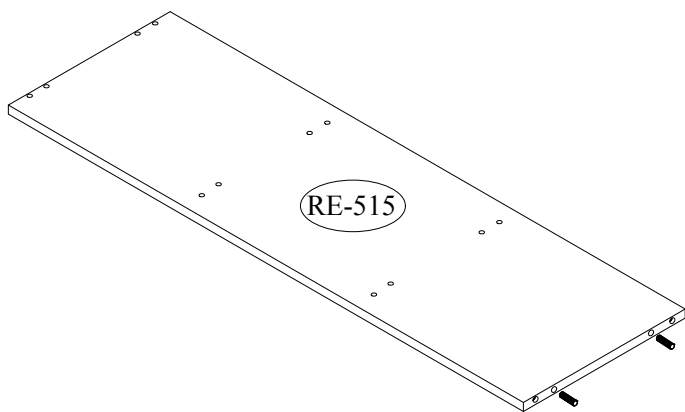

8.0x30

D
2

3

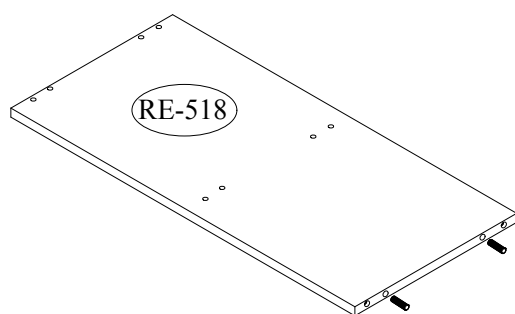

8.0x30

D
2

4

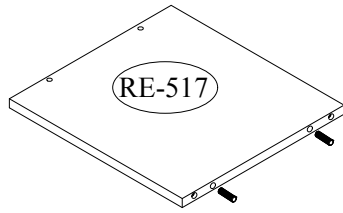

8.0x30

D
2

# 5





8.0x30

D
2

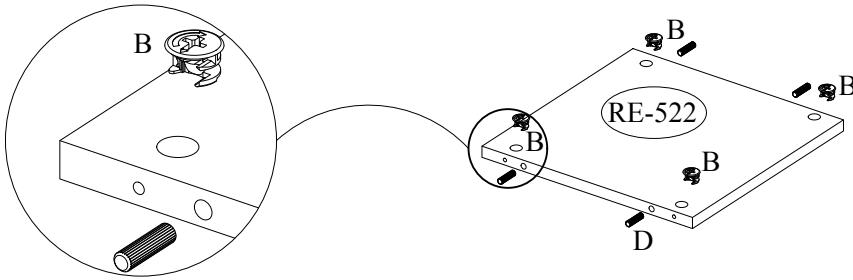
# 6

## 3x





	8.0x30
B	
3x4	D
	3x4

# 7

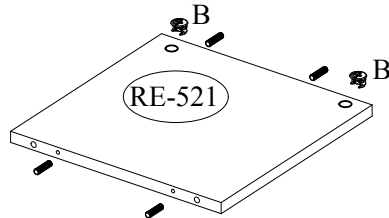

## 6x



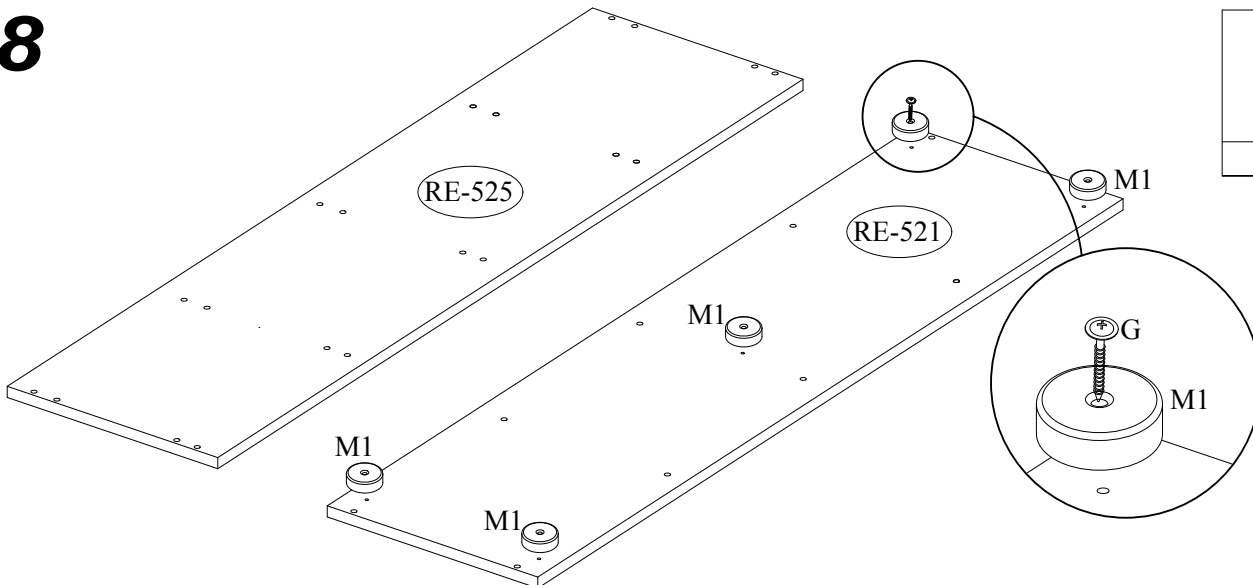

	8.0x30
B	
6x2	D
	6x4

# 8



	
M1	G
5	5

	
O	A1
16	12

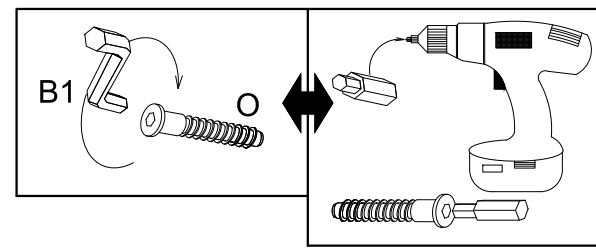
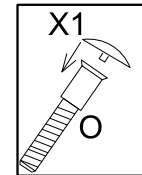
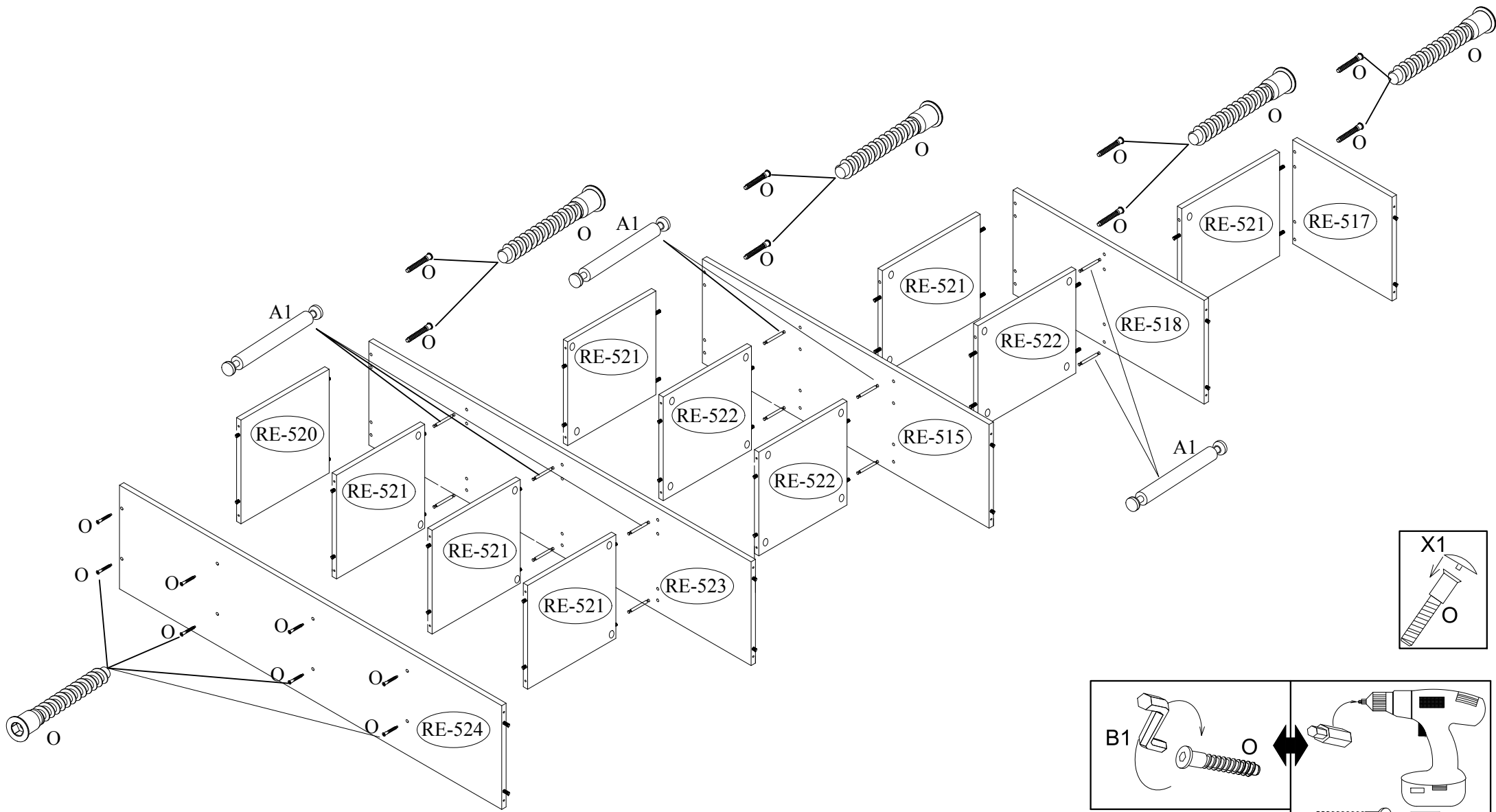

10

