

JUNIOR GOLD 1

PL INSTRUKCJA MONTAŻU

GB ASSEMBLY INSTRUCTIONS

CZ NÁVOD K MONTÁŽI

SK NÁVOD K MONTÁŽI

HU SZERELÉSI ÚTMUTATÓ

F MODEL D'EMPLOI

D MONTAGEANLEITUNG

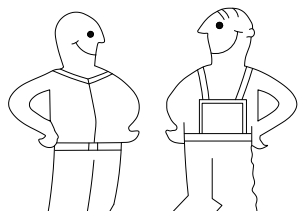

2 osoby
2 persons
2 osob
2 osôb
2 zeměkyk
2 personnes
2 personen

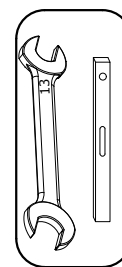
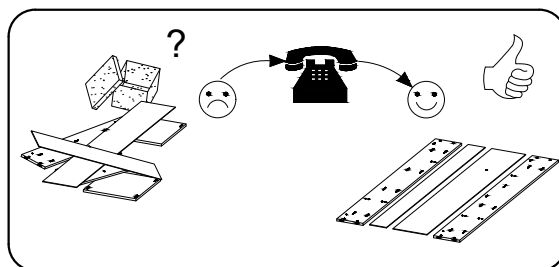
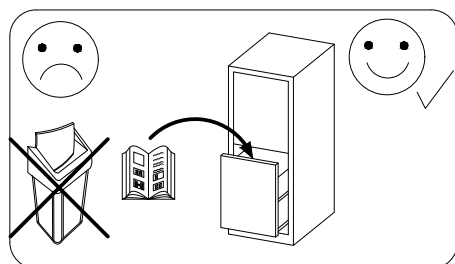
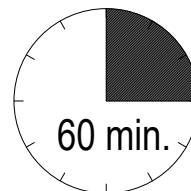

zalecane narzędzia
recommended tools
doporučené nástroje
odporúčané nástroje
ajánlott eszközöket
outils recommandés
empfohlene werkzeuge

AKCESORIA / ACCESSORIES / PŘÍSLUŠENSTVÍ / KIEGÉSZÍTŐK / ACCESSOIRES / ZUBEHÖR

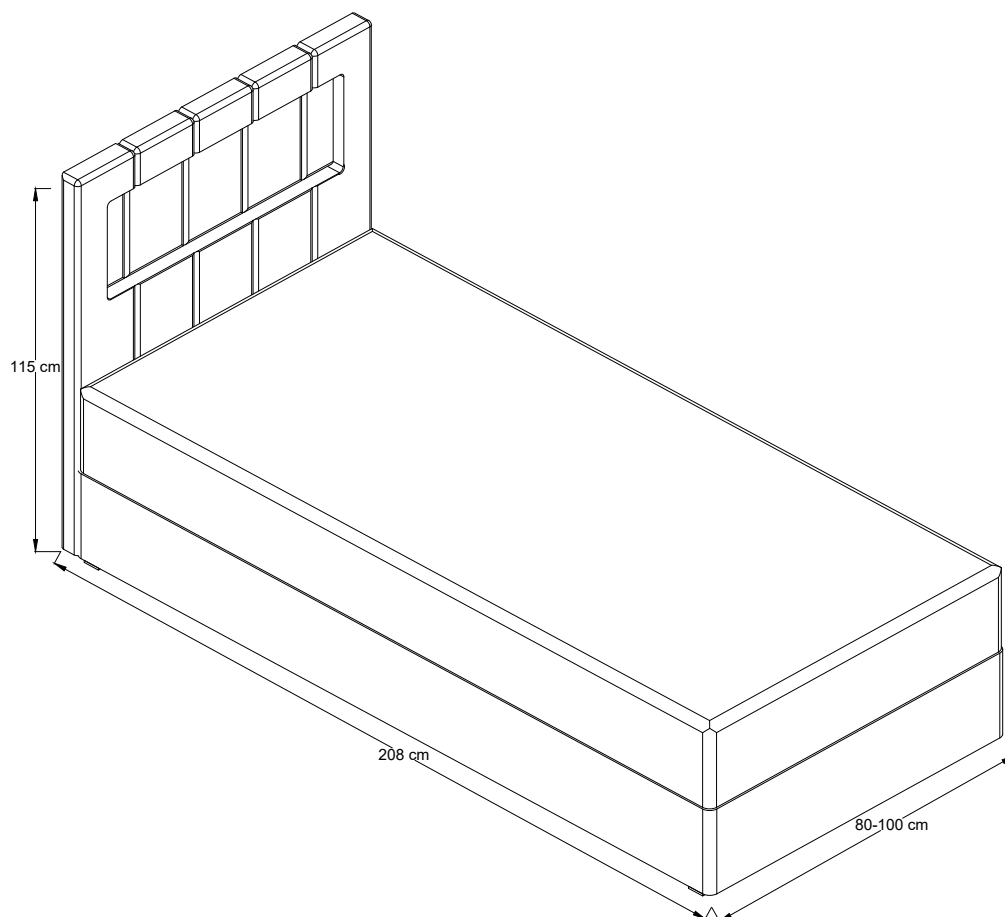
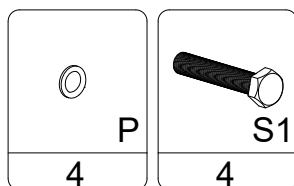

1

