

ELENA 2D

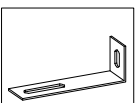

L19

1

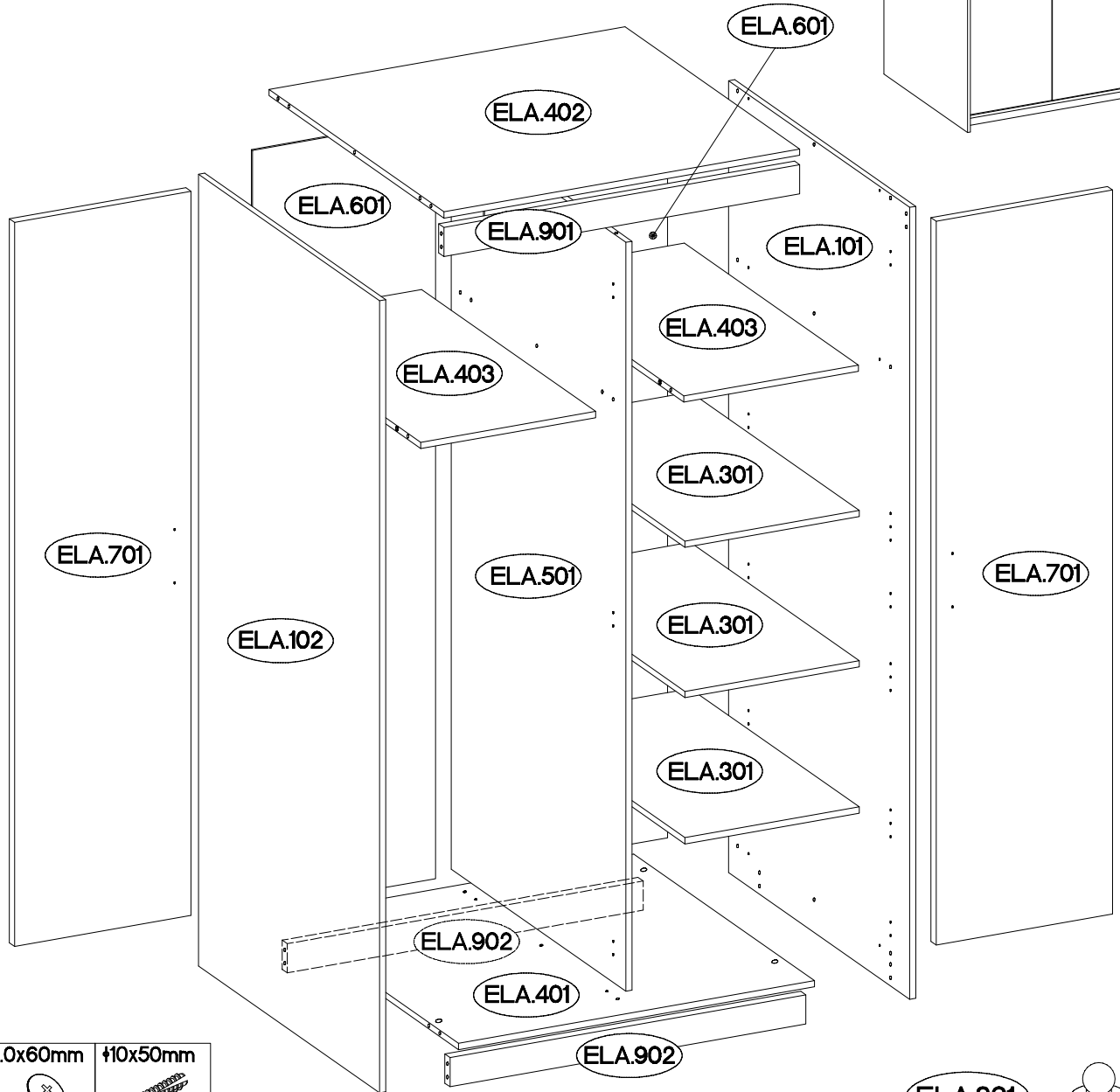
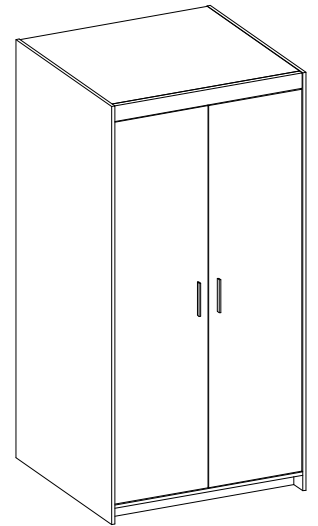
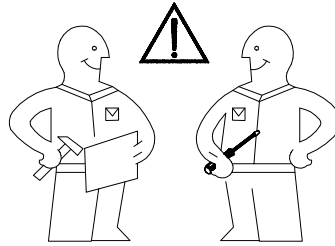
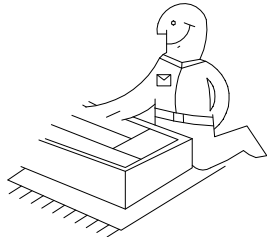
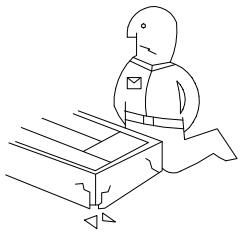
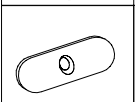

L2

14

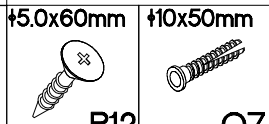

P12

1



O7

1

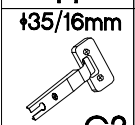

G2

6

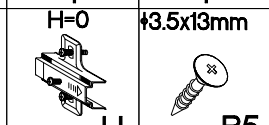

H

6



P5

16

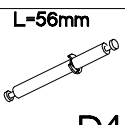

D4

2

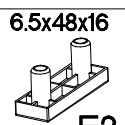

F2

4

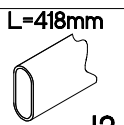

J2

1

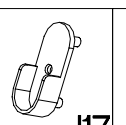

J17

2

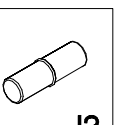

J3

12

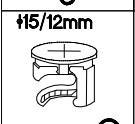

C

20

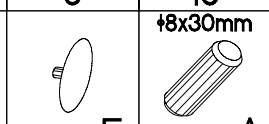

E

20

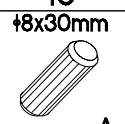

A

42

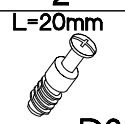

D2

16

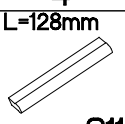

S11

2



R1

4

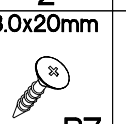

P7

57

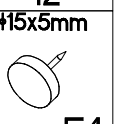



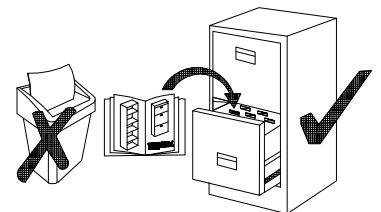
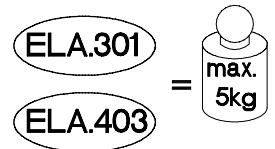

F4

2



ISM-ELA-02

1

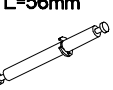
| | | | | | |
|---|---|--|--|--|--|
|  C |  A |  D2 |  F4 |  F2 |  D4 |
| 16 | 42 | 12 | 2 | 4 | 2 |

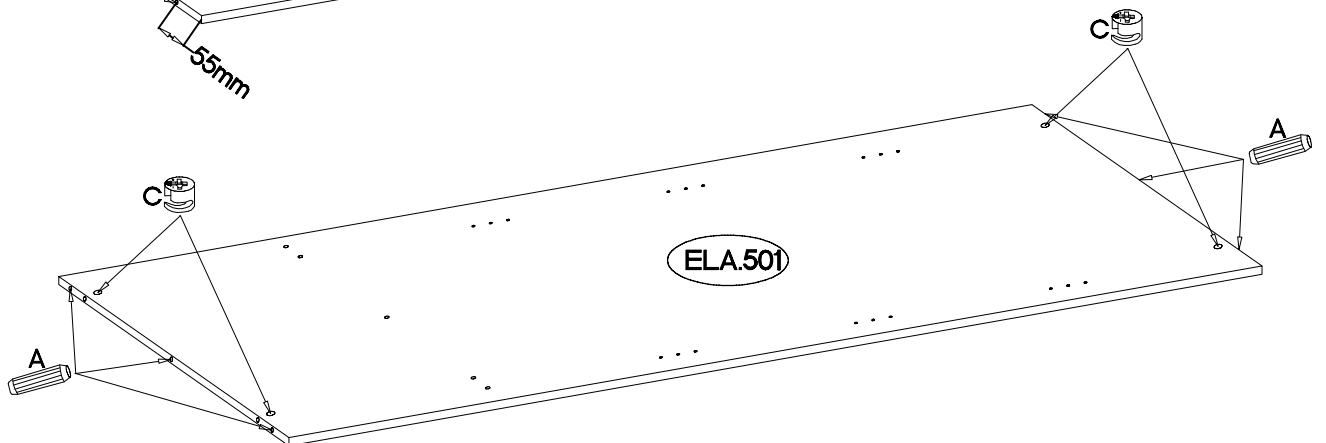
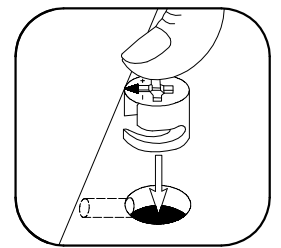
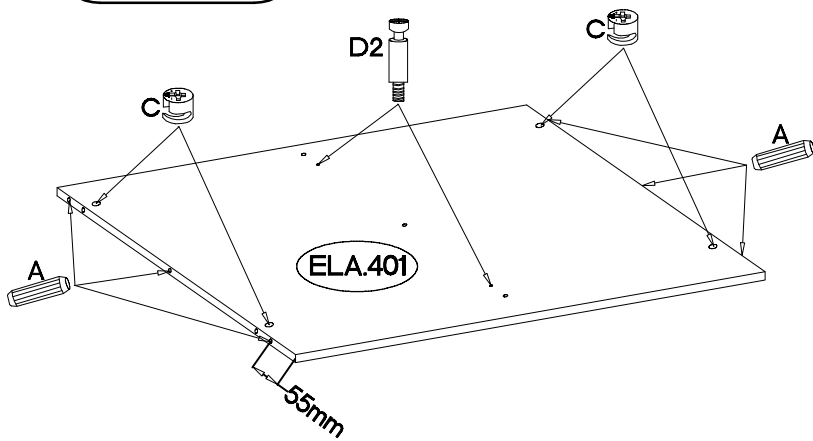
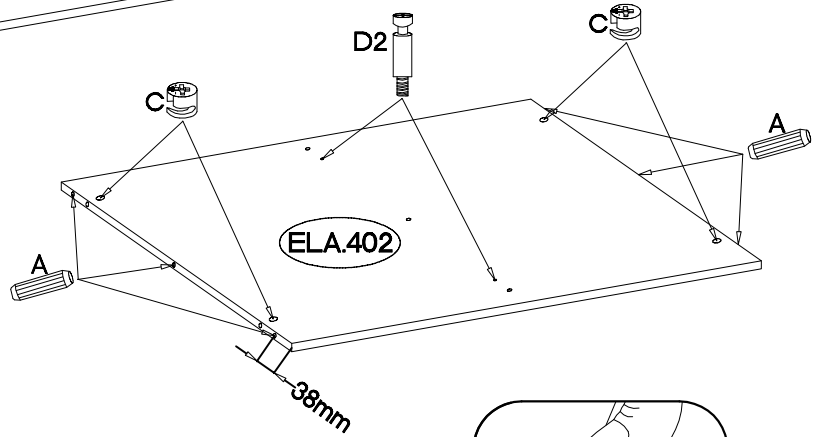
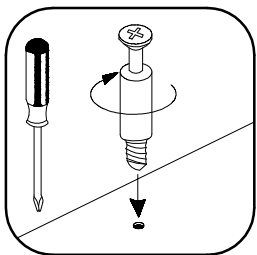
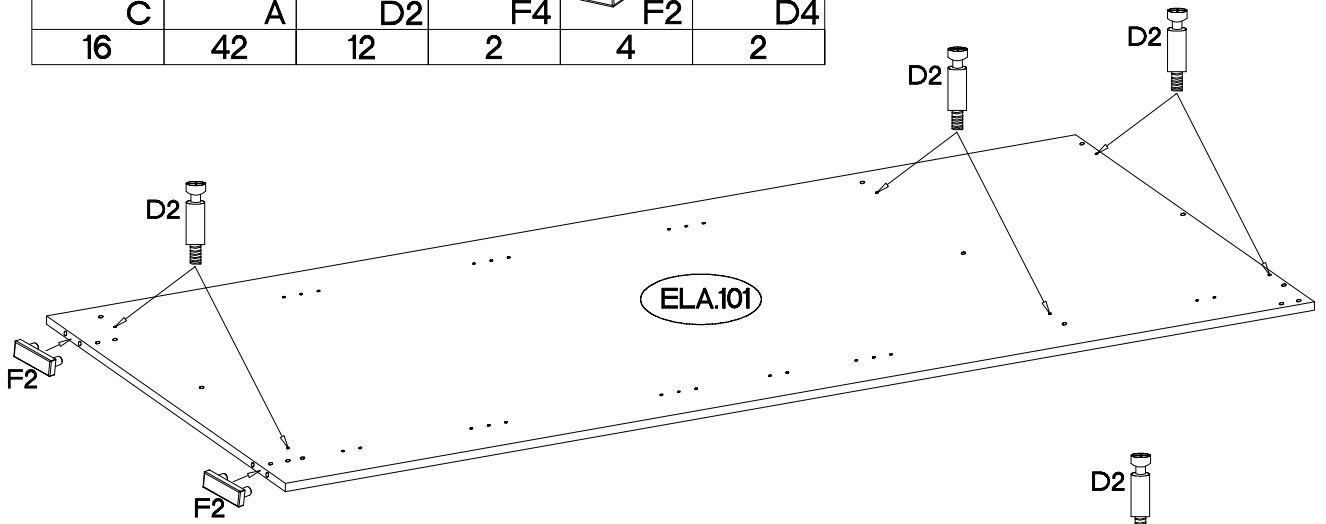

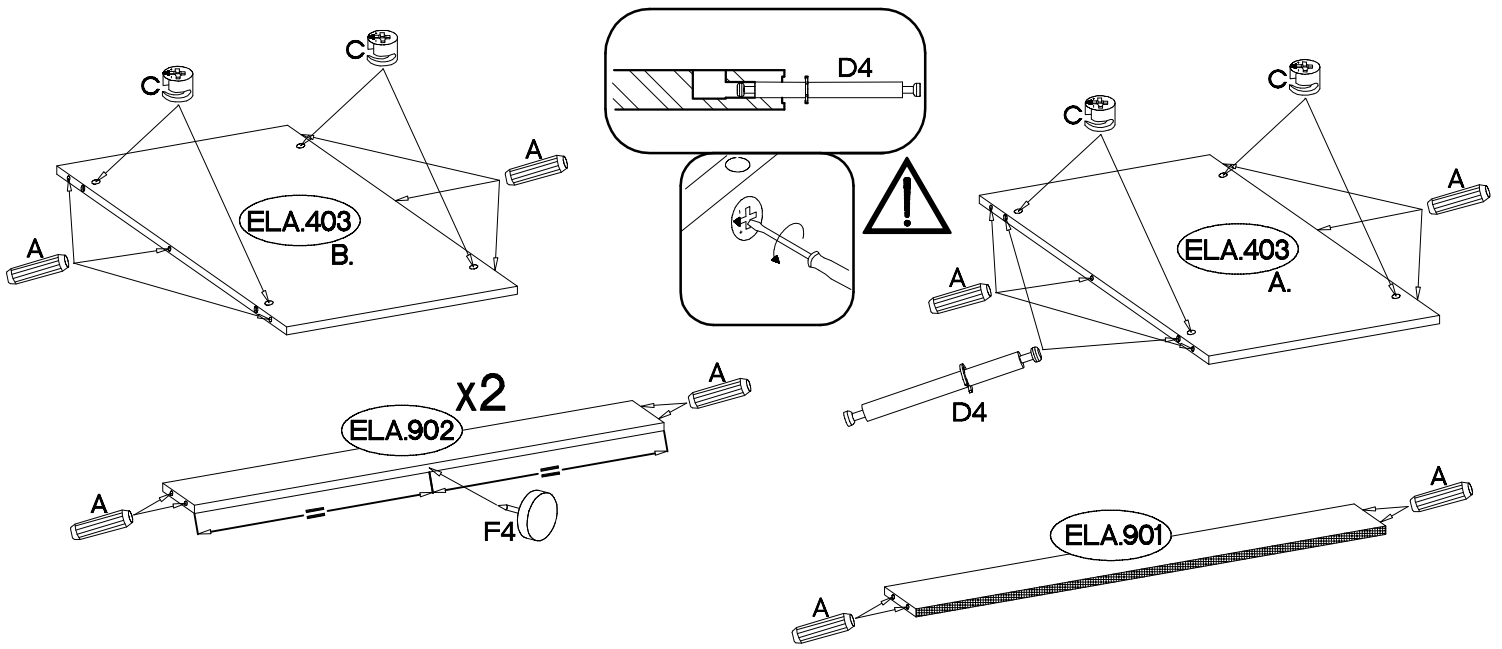

2

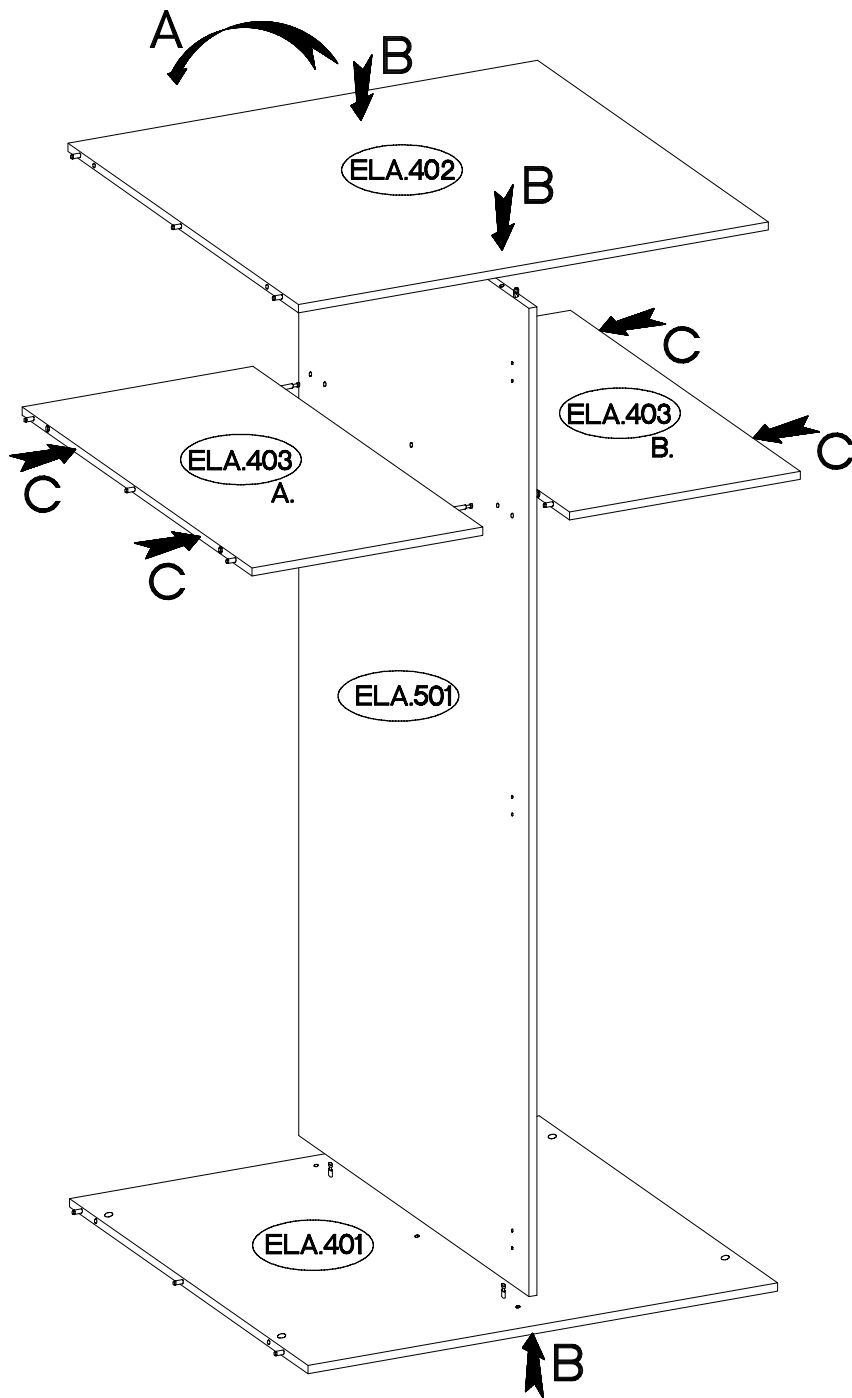

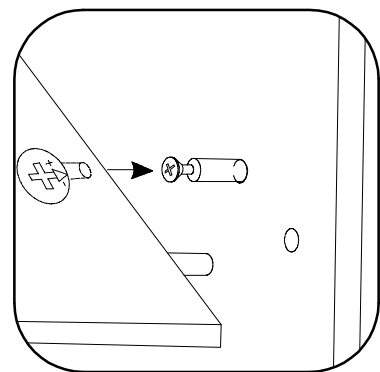
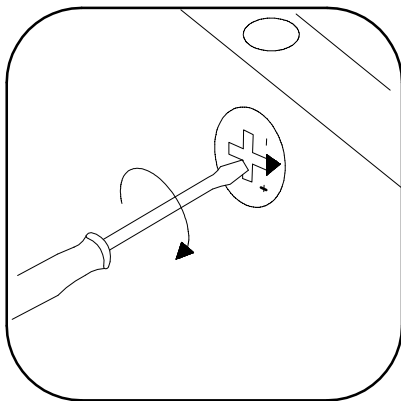
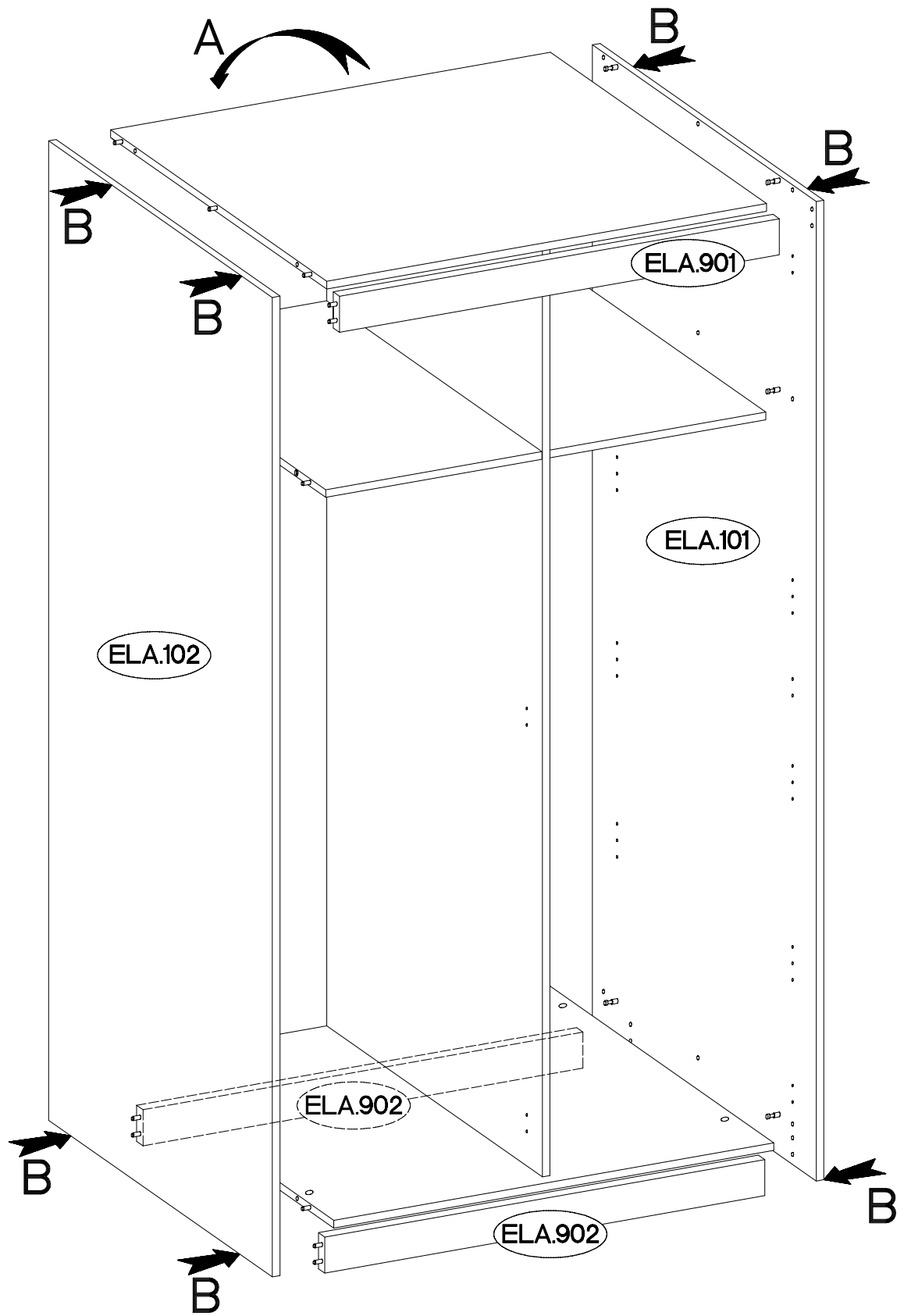

3

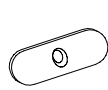

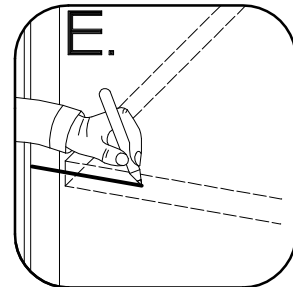
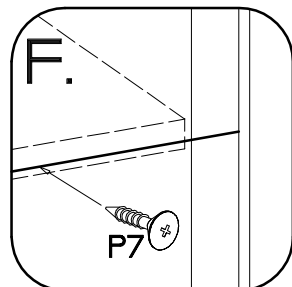
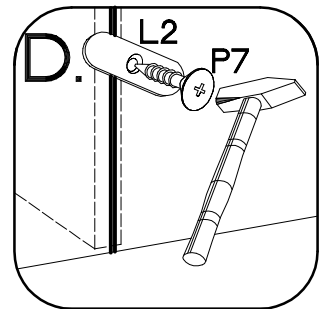
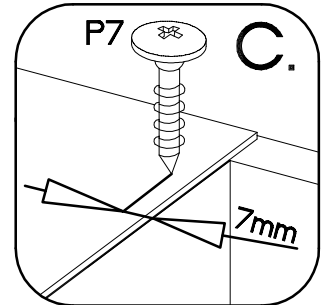
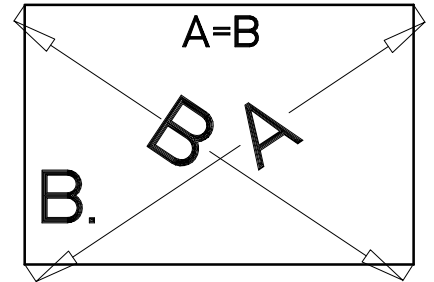
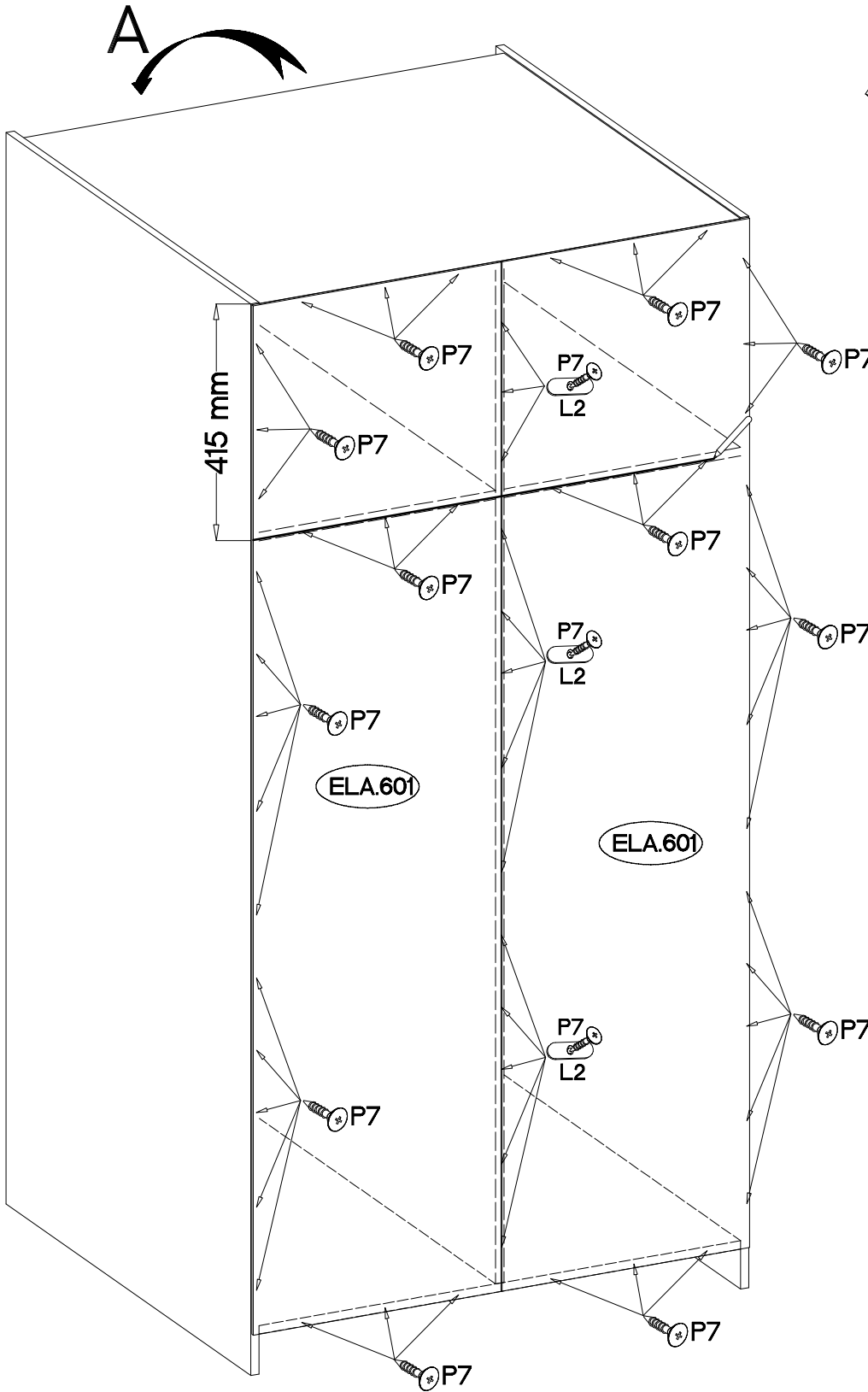
| | |
|--|-----------|
|  | 43.0x20mm |
| L2 | P7 |
| 14 | 57 |





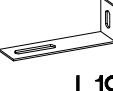

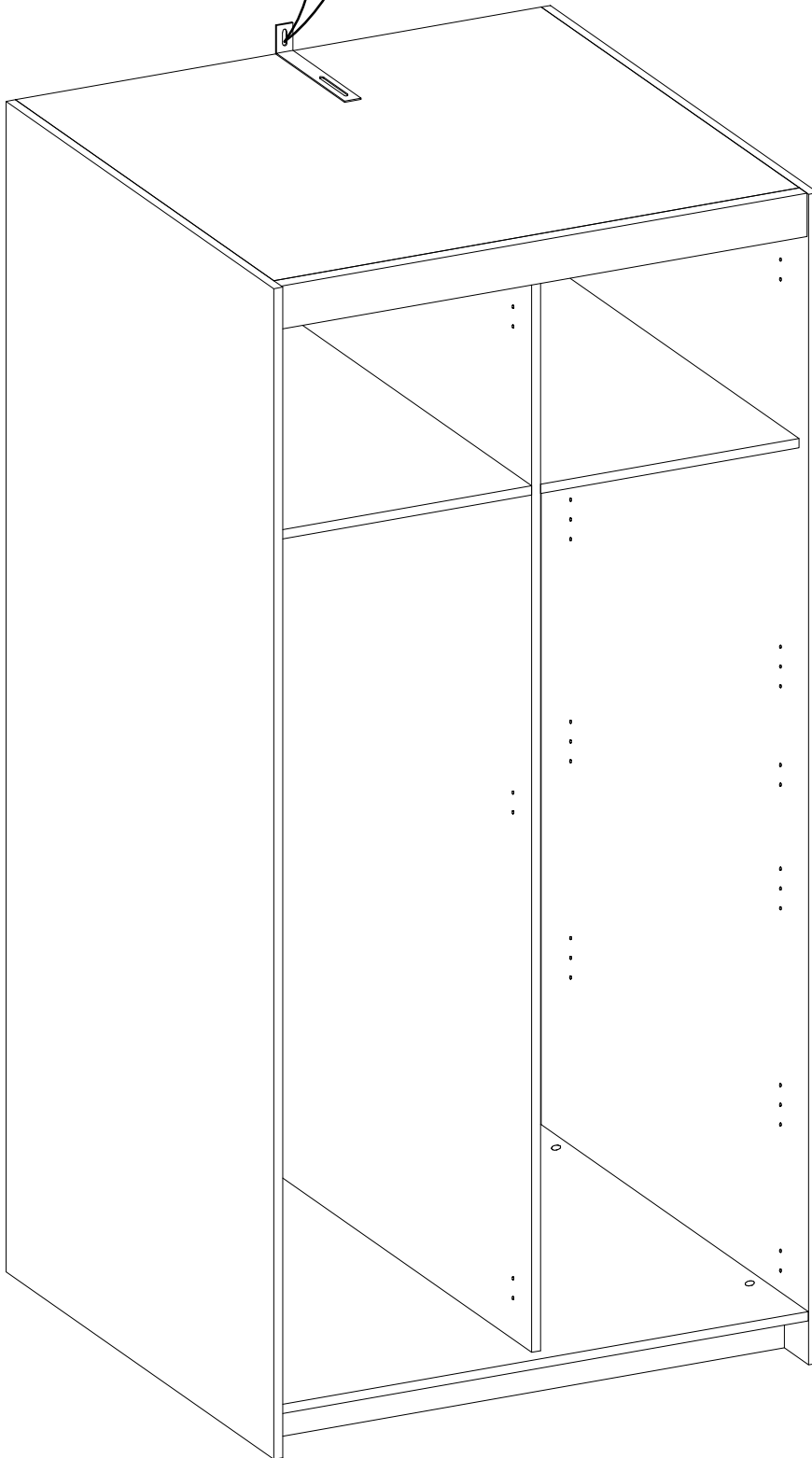
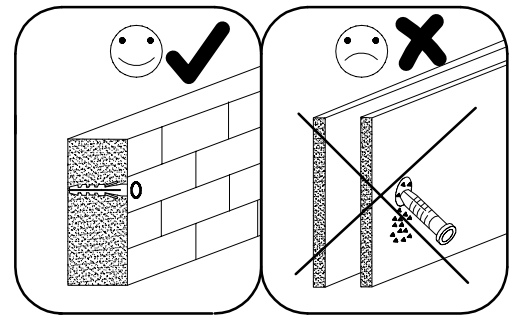
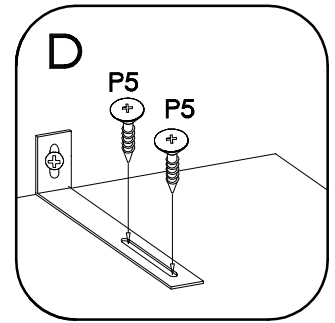
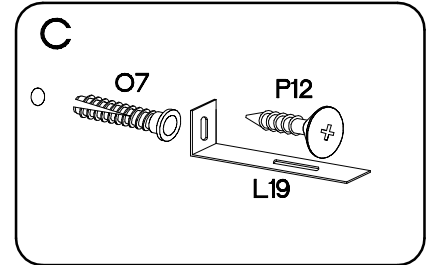
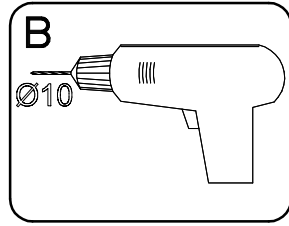
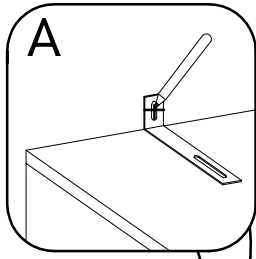
5

| | | | |
|--|---|---|--|
|  P12 1 |  O7 1 |  P5 2 |  L19 1 |
|--|---|---|--|



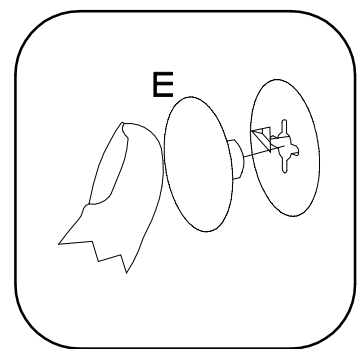
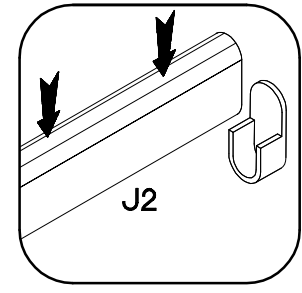
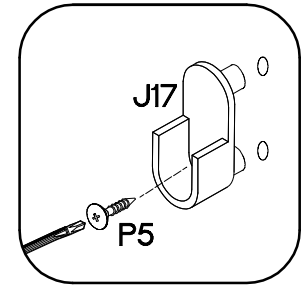
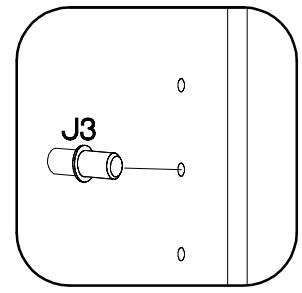
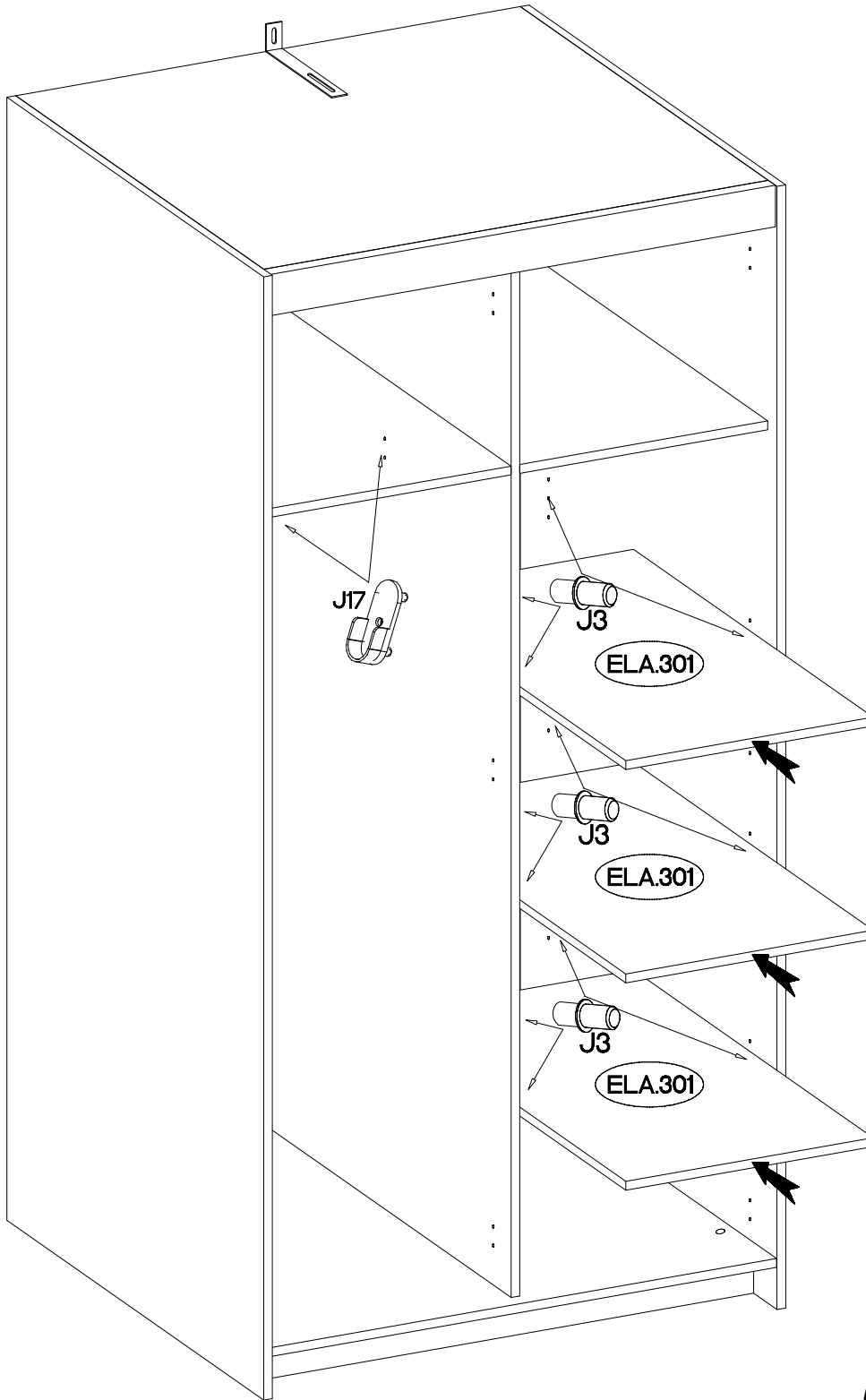

6

| | | | | |
|--|--|--|--|---|
|  |  |  |  |  |
| J3 | E | J2 | J17 | P5 |
| 12 | 16 | 1 | 2 | 2 |



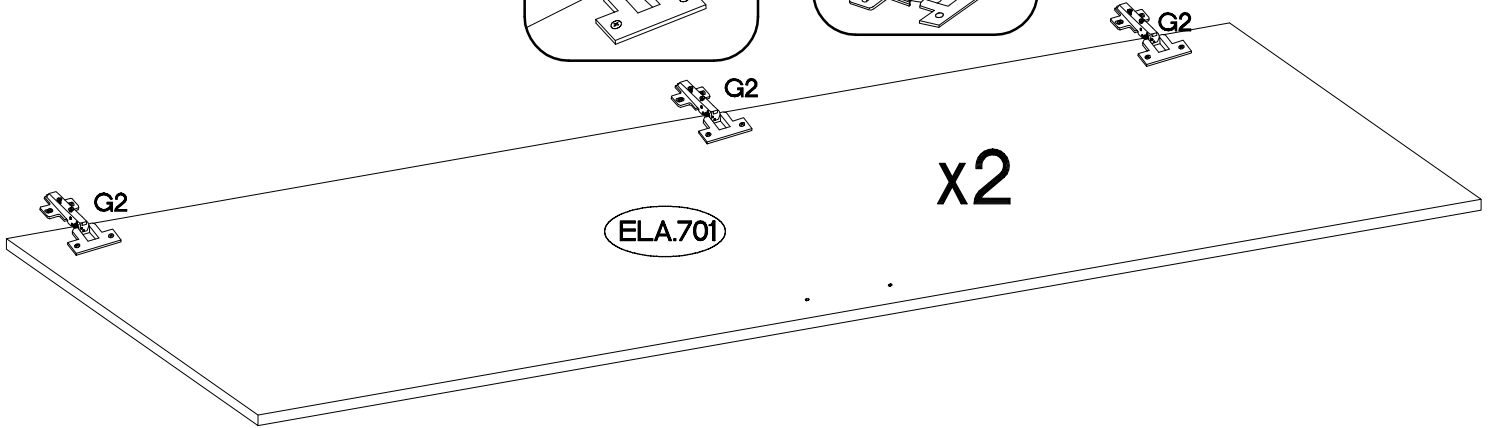
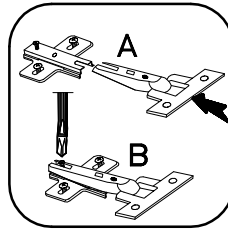
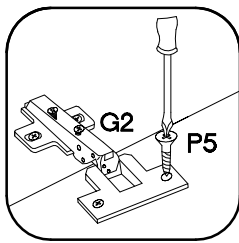

7

| | | |
|---|---|---|
| ±35/16mm  G2 6 | H=0  H 6 | ±3.5x13mm  P5 12 |
|---|---|---|



8

| | |
|--|---|
| L=128mm  S11 3 | ±4.0x27mm  R1 6 |
|--|---|

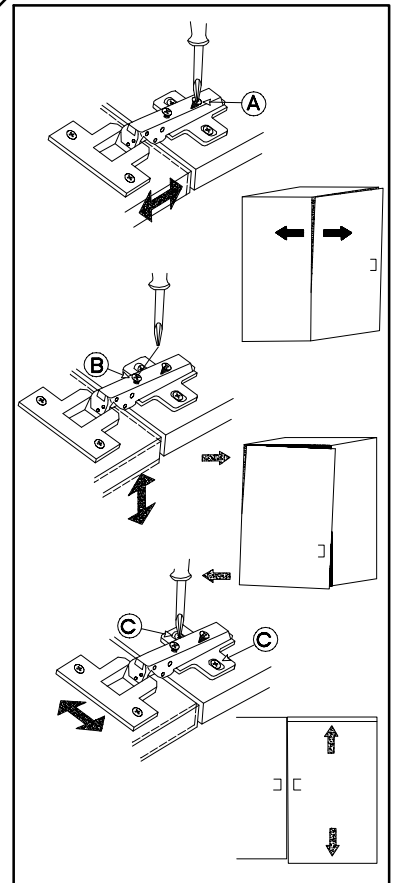
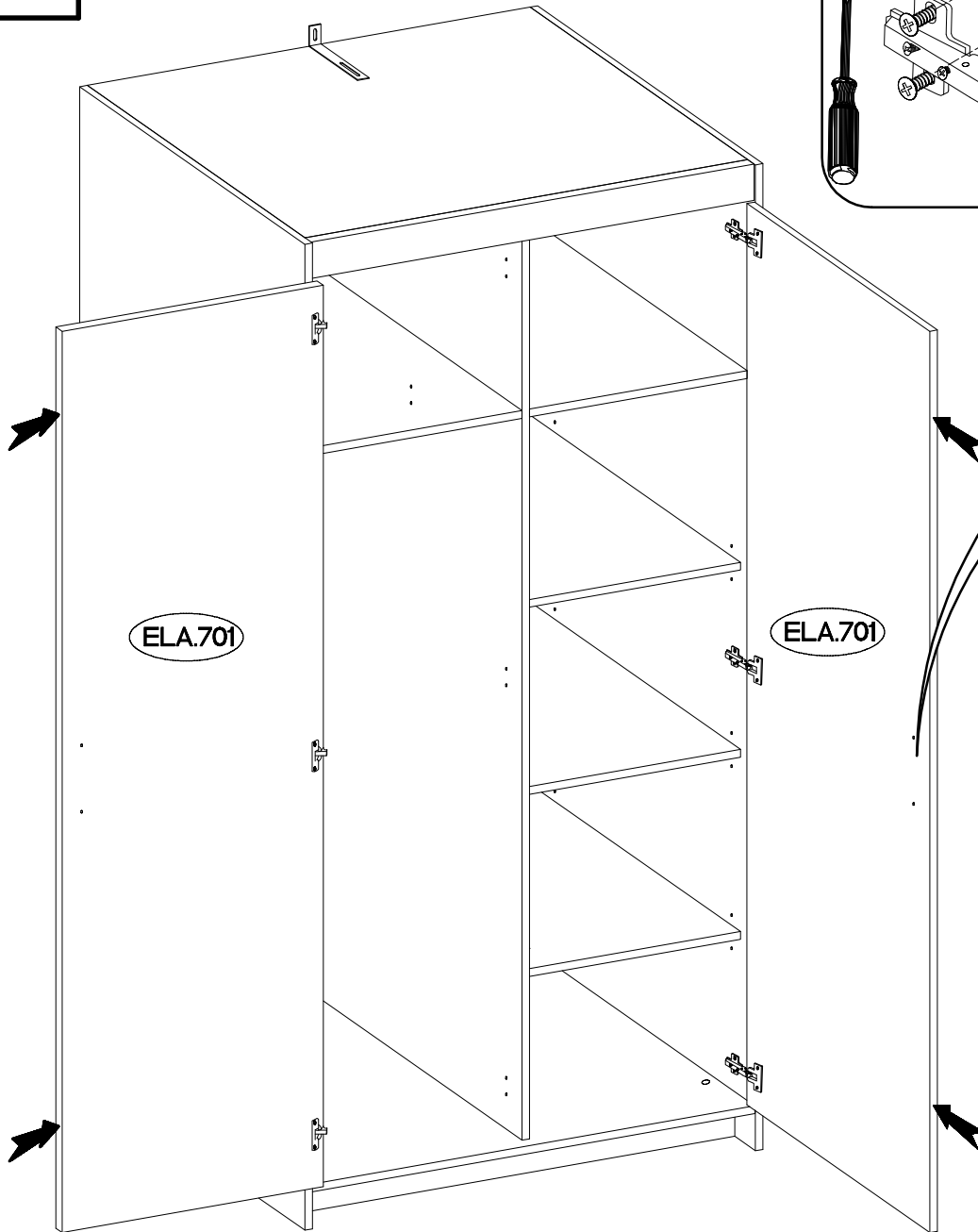
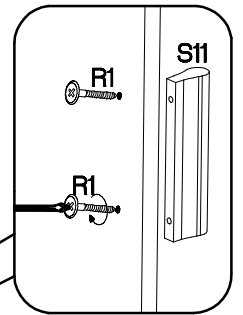
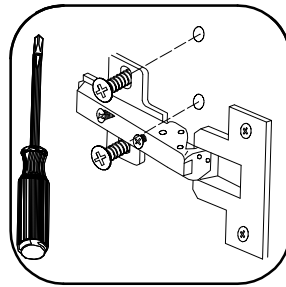

ELENA NA 2D

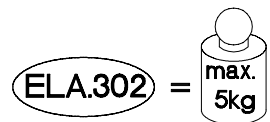
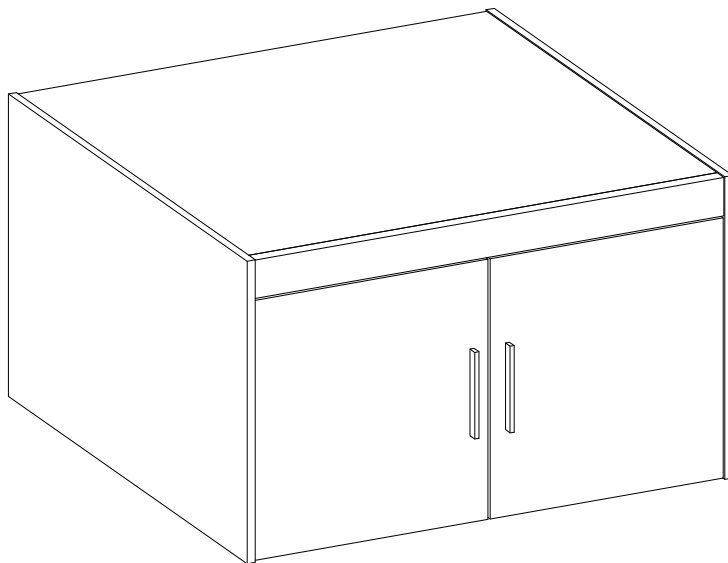
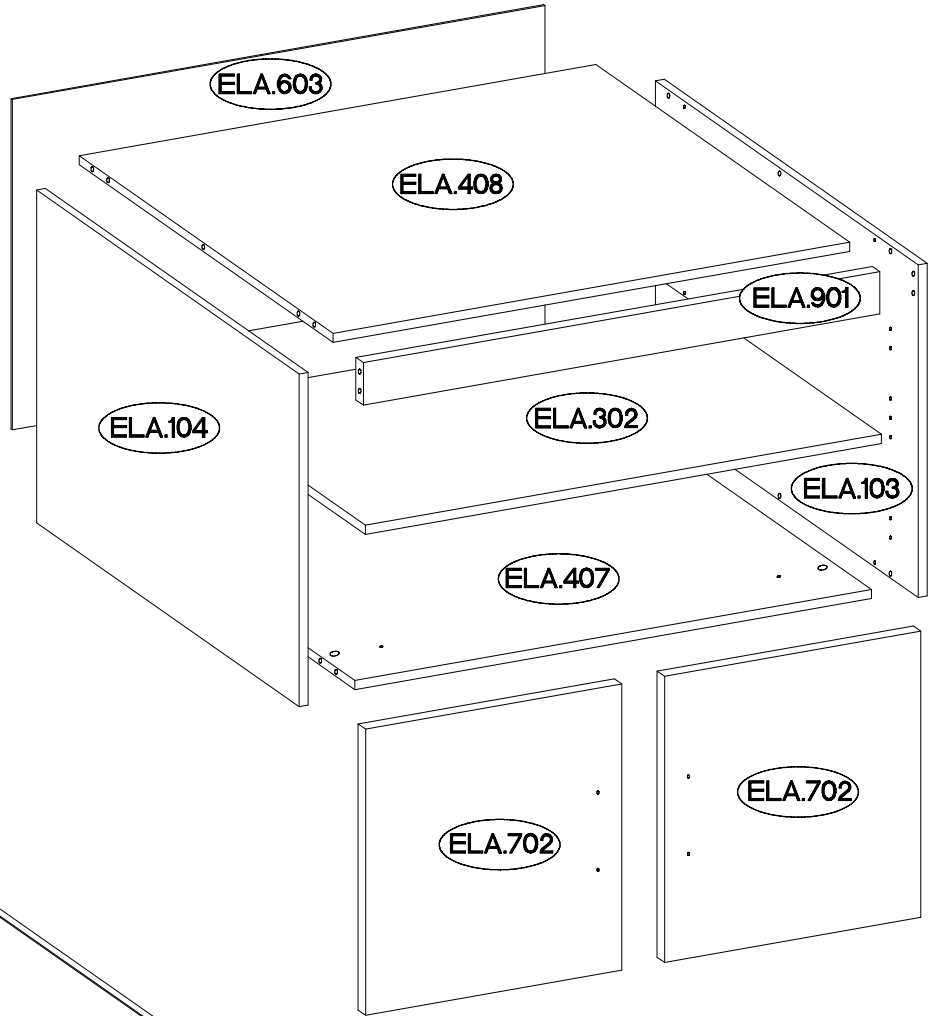
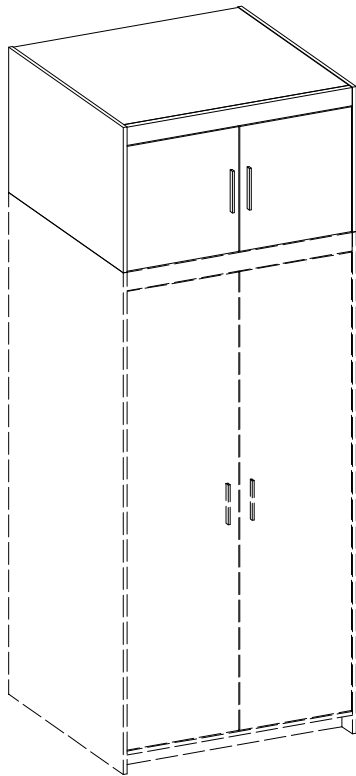
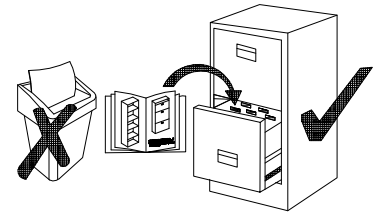
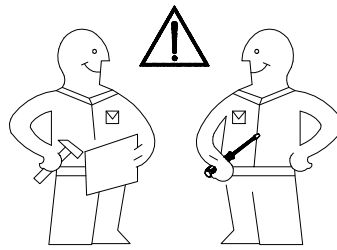
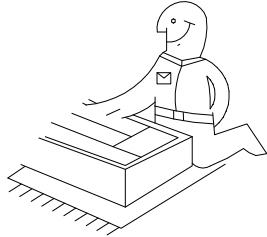
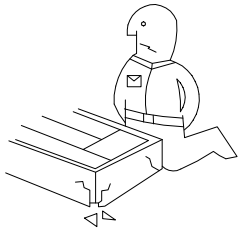

| | | | |
|--|---------------------------------|--------------|---|
| $\pm 4.0 \times 25 \text{mm}$ R | $\pm 35/16 \text{mm}$ G2 | H=0 H | $\pm 3.5 \times 13 \text{mm}$ P5 |
| 4 | 4 | 4 | 8 |

| | | | | | | | |
|--------------------|---|---|--------|--------------------------------|-------|--------------------------------------|------------------|
| L=128mm S11 | $\pm 4.0 \times 27 \text{mm}$ R1 | $\pm 3.0 \times 20 \text{mm}$ P7 | J3 | $\pm 15/12 \text{mm}$ C | E | $\pm 8 \times 30 \text{mm}$ A | L=20mm D2 |
| 2 | 4 | 20 | 4 | 8 | 8 | 16 | 8 |

ISM-ELA-04

1

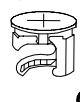
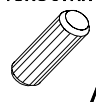
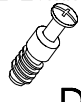
| | | |
|--|--|--|
| $\varnothing 15/12\text{mm}$  | $\varnothing 8 \times 30\text{mm}$  | L=20mm  |
| C 8 | A 16 | D2 8 |

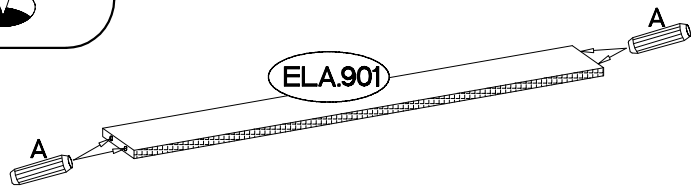
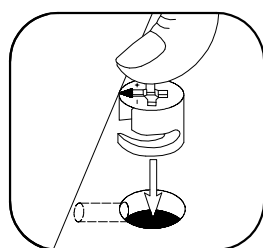
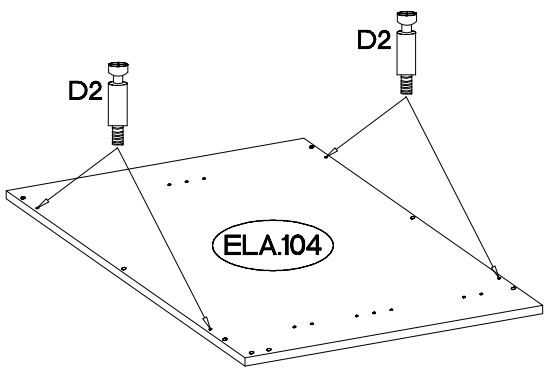
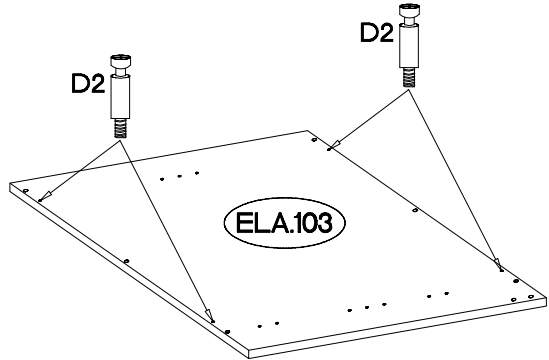
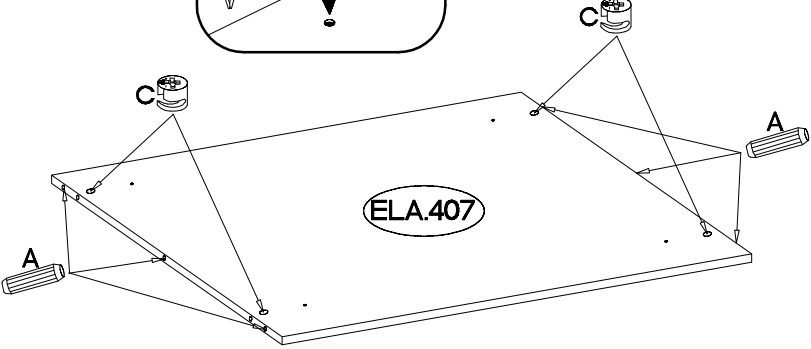
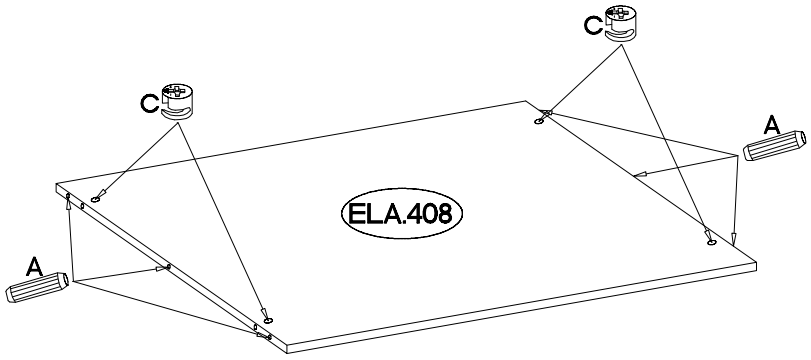
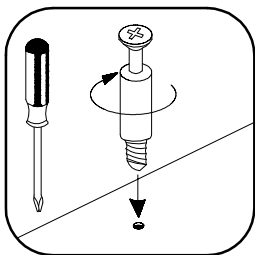

2

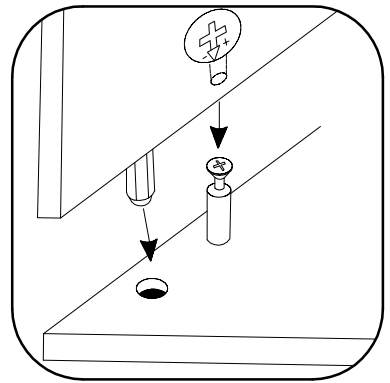
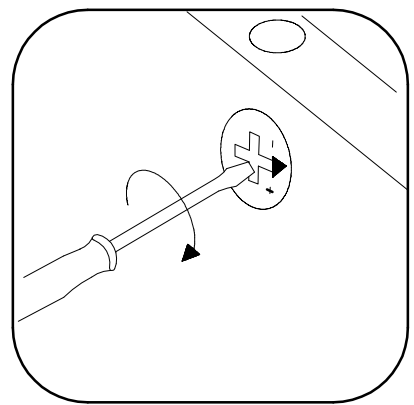
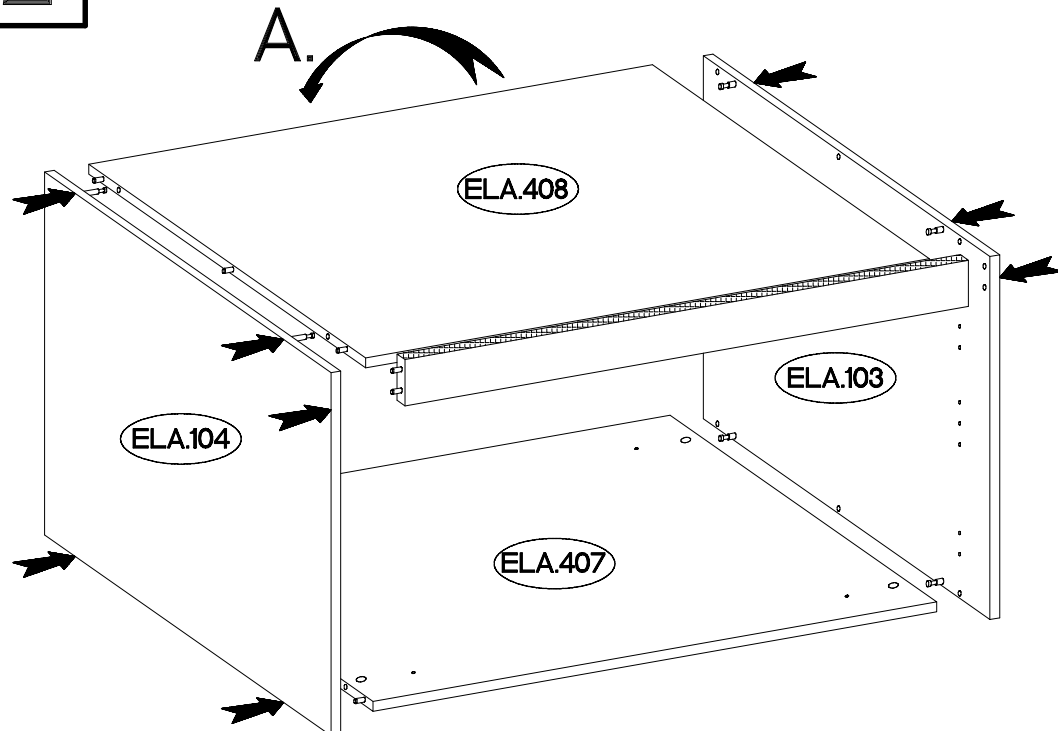

3

±3.0x20mm



P7

20

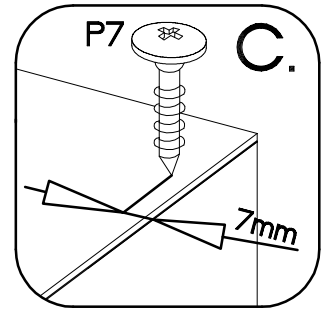
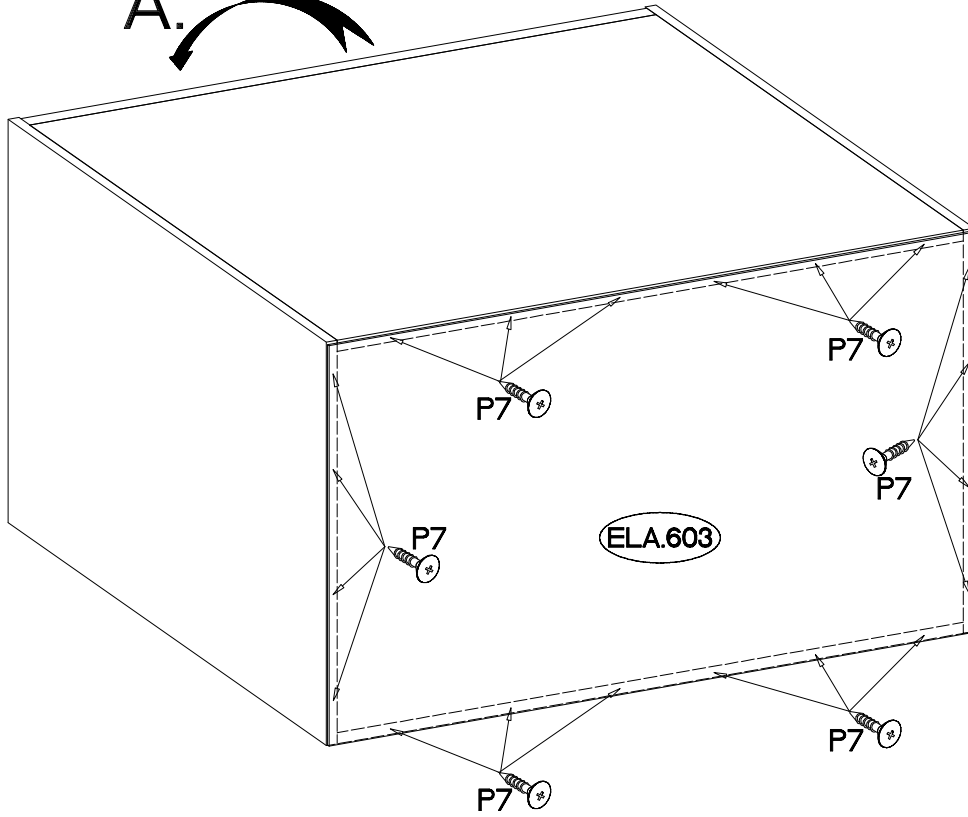
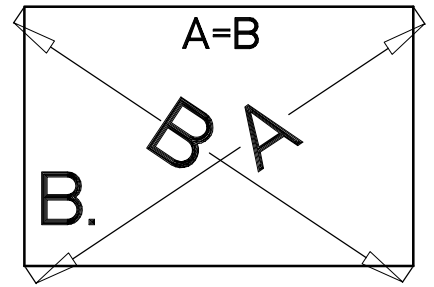

4

±35/16mm



G2

4

H=0



H

4

±3.5x13mm



P5

8

L=128mm

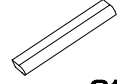

S11

2

±4.0x27mm



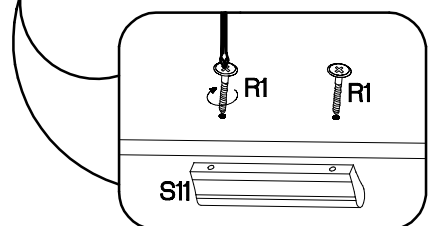
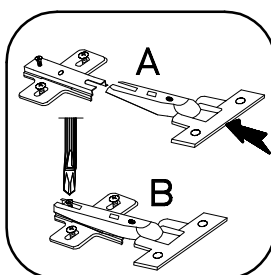
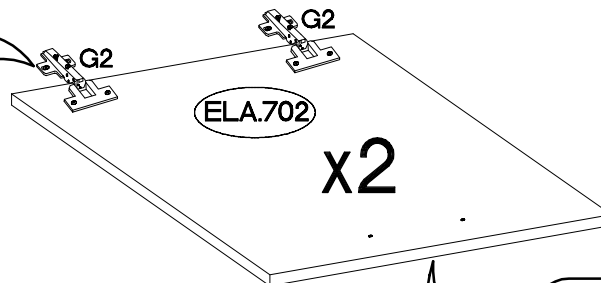
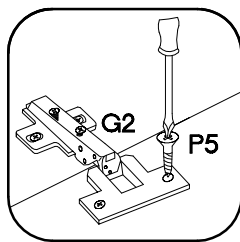

R1

4



5

| | |
|--|--|
|  |  |
| J3 | E |
| 4 | 8 |

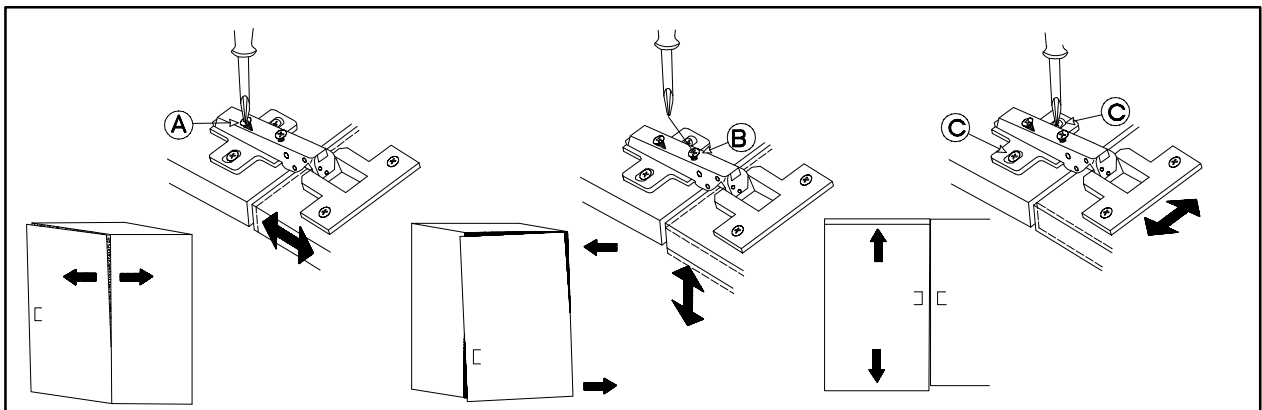
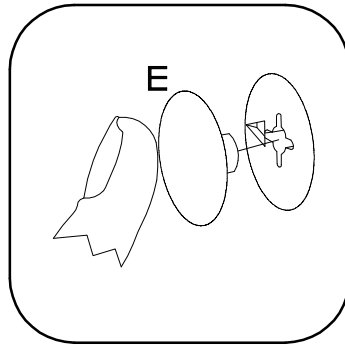
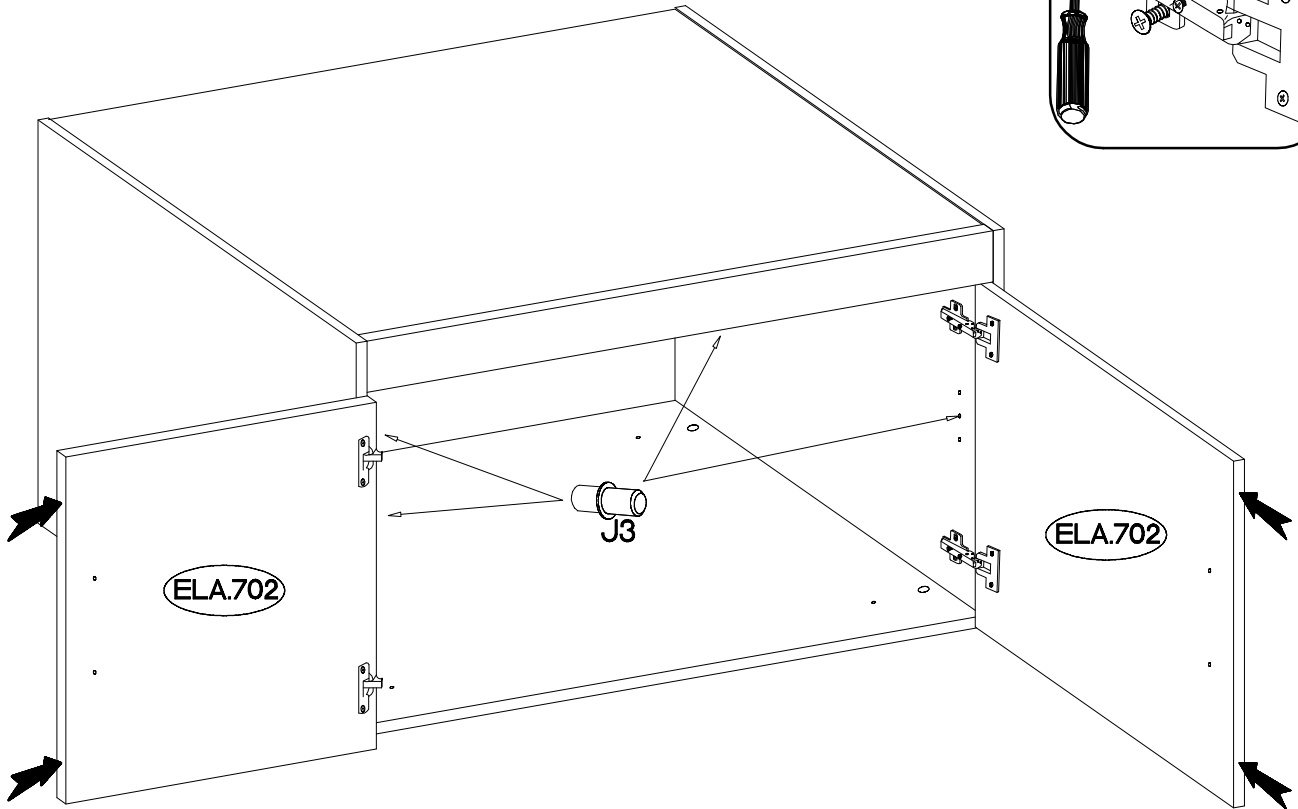
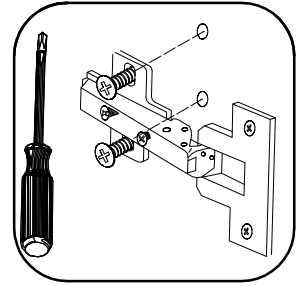

6

±4.0x25mm



R

4

