

# ELENA 3D

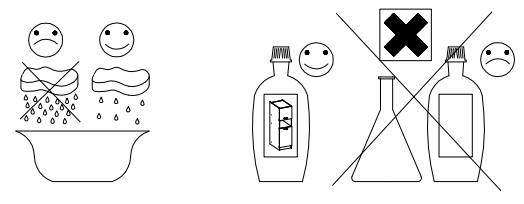

	$\dagger 5.0 \times 60 \text{mm}$	$\dagger 10 \times 50 \text{mm}$								
14	1	1	1							
$\dagger 35/16 \text{mm}$	H=0	$\dagger 3.5 \times 13 \text{mm}$	L=56mm	6.5x48x16	L=851mm		$\dagger 5/16 \text{mm}$	$\dagger 35/9 \text{mm}$	$\dagger 4.0 \times 16 \text{mm}$	
6	9	22	2	4	1	2	12	3	4	2
$\dagger 15/12 \text{mm}$		$\dagger 8 \times 30 \text{mm}$	L=20mm	L=128mm	$\dagger 4.0 \times 30 \text{mm}$	$\dagger 3.0 \times 20 \text{mm}$	$\dagger 15 \times 5 \text{mm}$			
20	20	42	16	3	6	66	2			

P-ISM-ELA-02

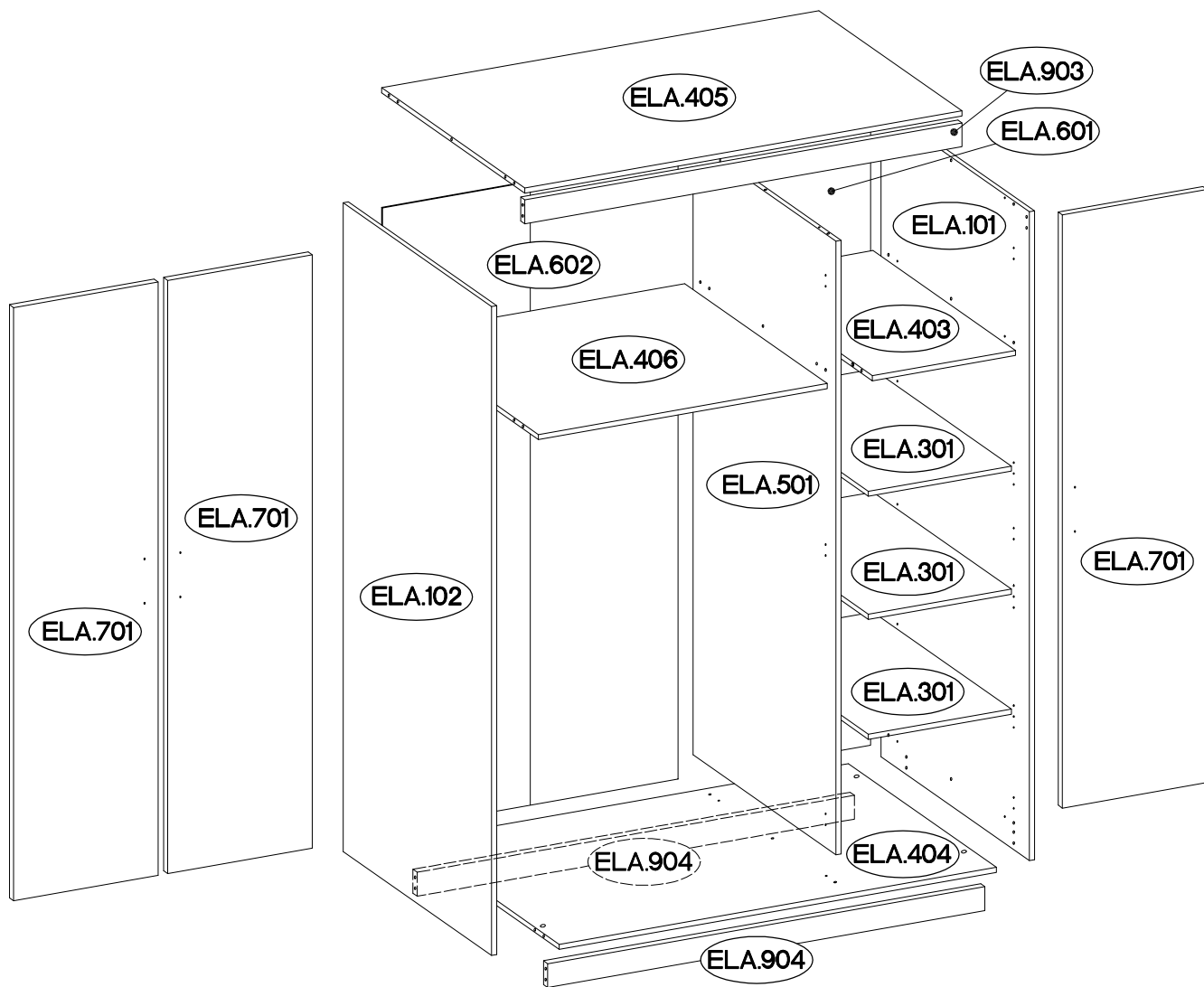

Colli	Ersatzteil Nummer	Dimension
Colli 1/3	ELA.301 x3	425x495x15
	ELA.403	426x510x15
	ELA.404	1300x529x15
	ELA.405	1300x512x15
	ELA.406	859x510x15
	ELA.903	1300x70x15
	ELA.904 x2	1300x70x15

Colli	Ersatzteil Nummer	Dimension
Colli 2/3	ELA.601	1825x446x2,5
	ELA.602	1825x879x2,5
	ELA.701 x3	1737x430x15

Colli	Ersatzteil Nummer	Dimension
Colli 3/3	ELA.101	1900x530x15
	ELA.102	1900x530x15
	ELA.501	1797x511x15

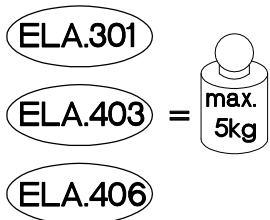

L=56mm	∅15/12mm	∅8x30mm	L=20mm	∅15x5mm	∅4.0x16mm		6.5x48x16
D4	C	A	D2	F4	P1	T3	F2
2	20	42	16	2	2	2	4

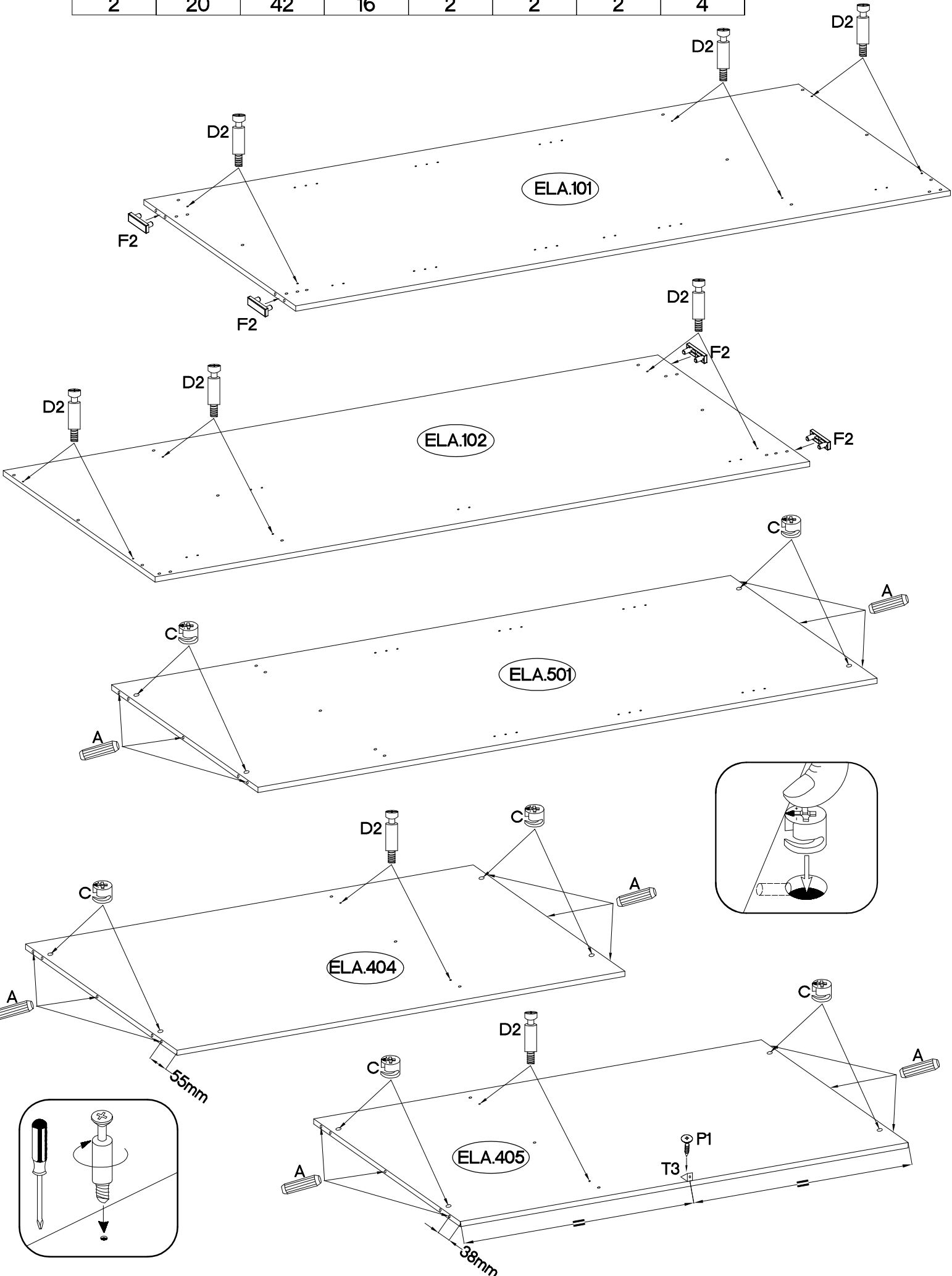

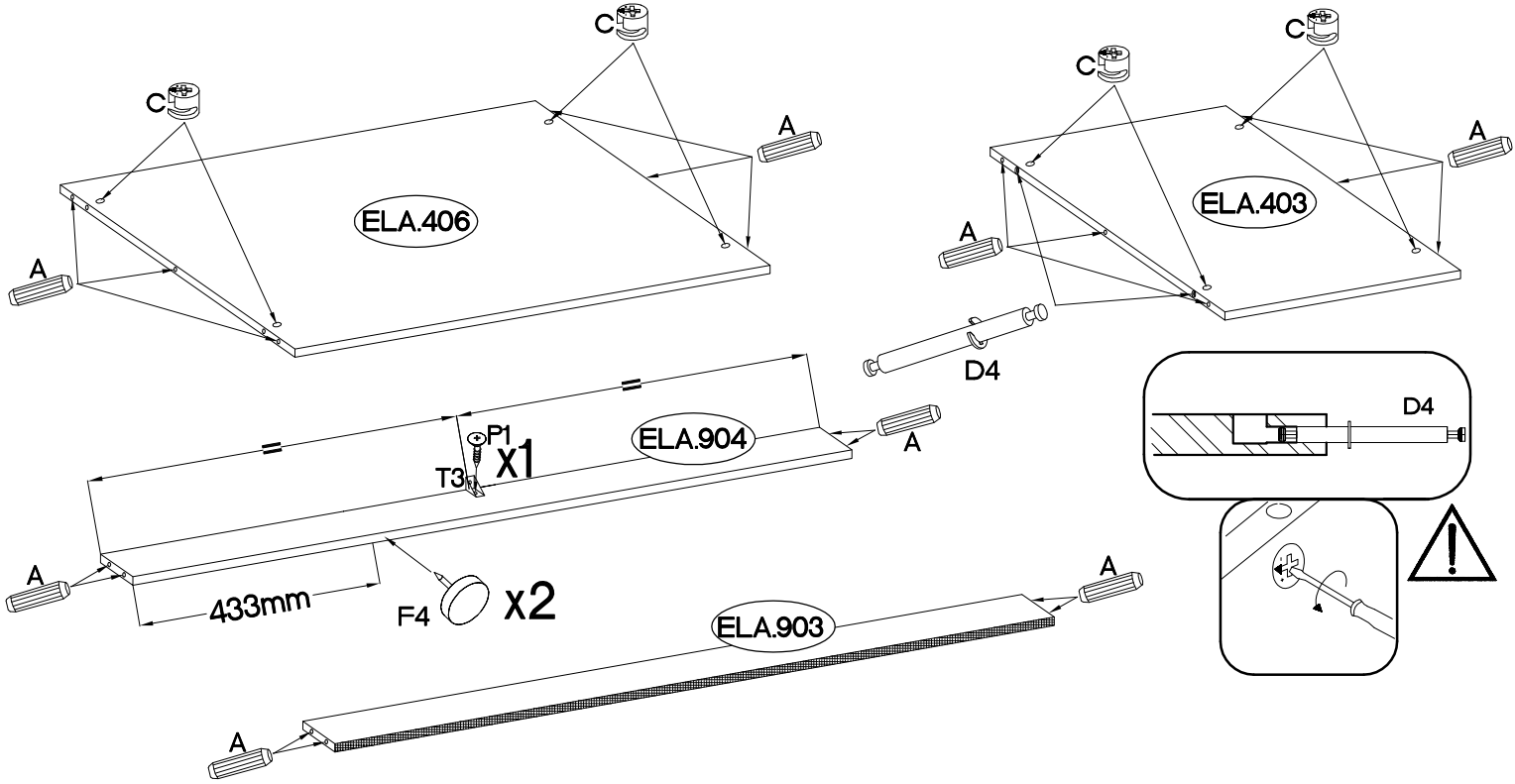

2

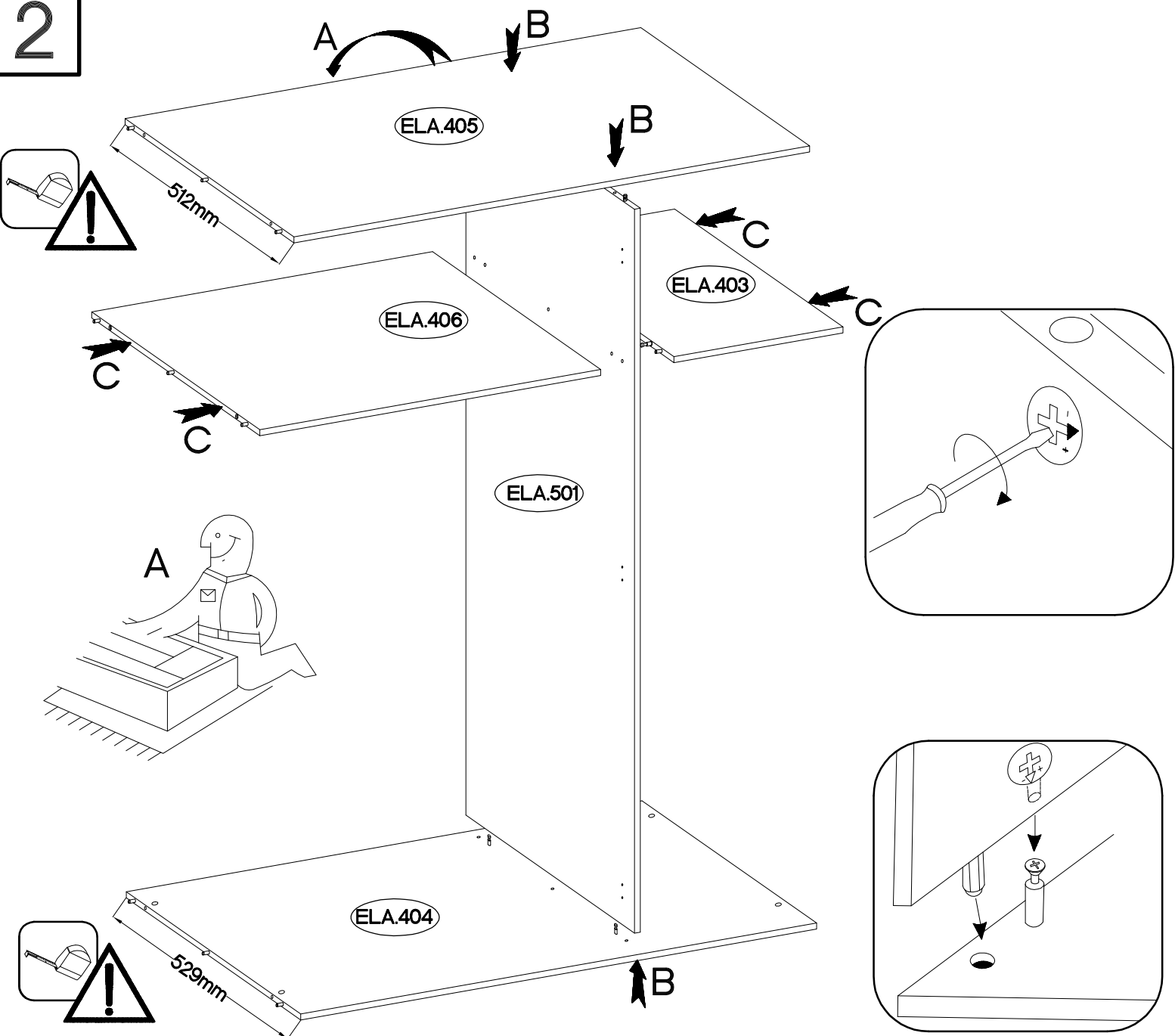

3

4.0x16mm  
P1  
2



A



B



B



ELA.903

ELA.101

ELA.102

ELA.904

ELA.904

B



B



B

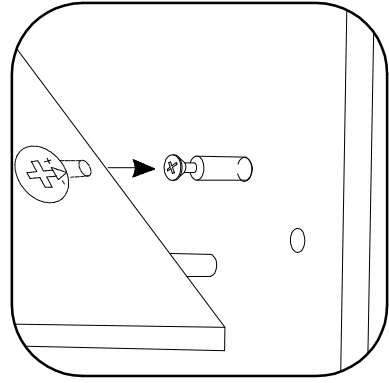
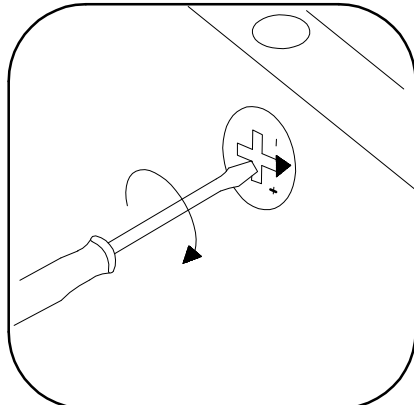
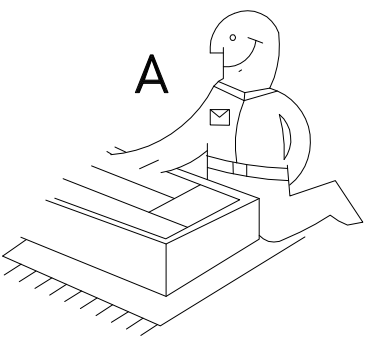
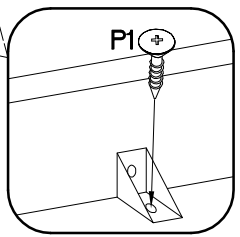

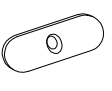

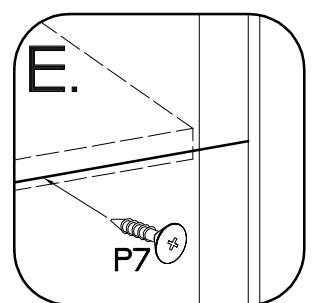
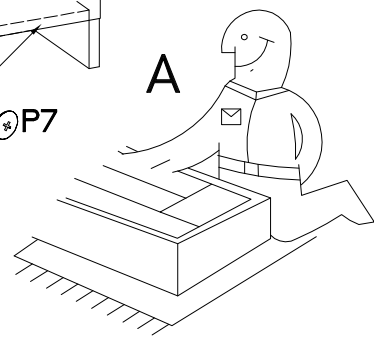
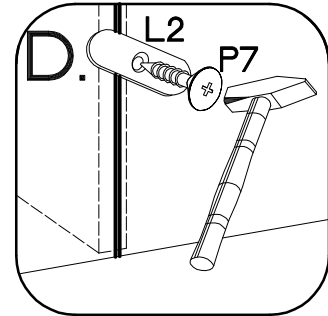
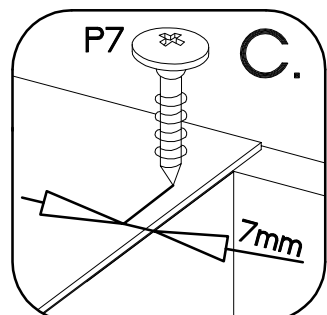
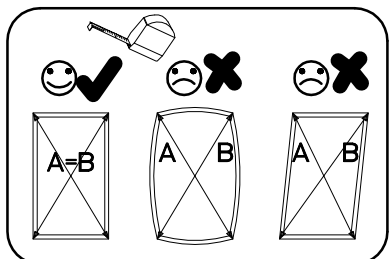
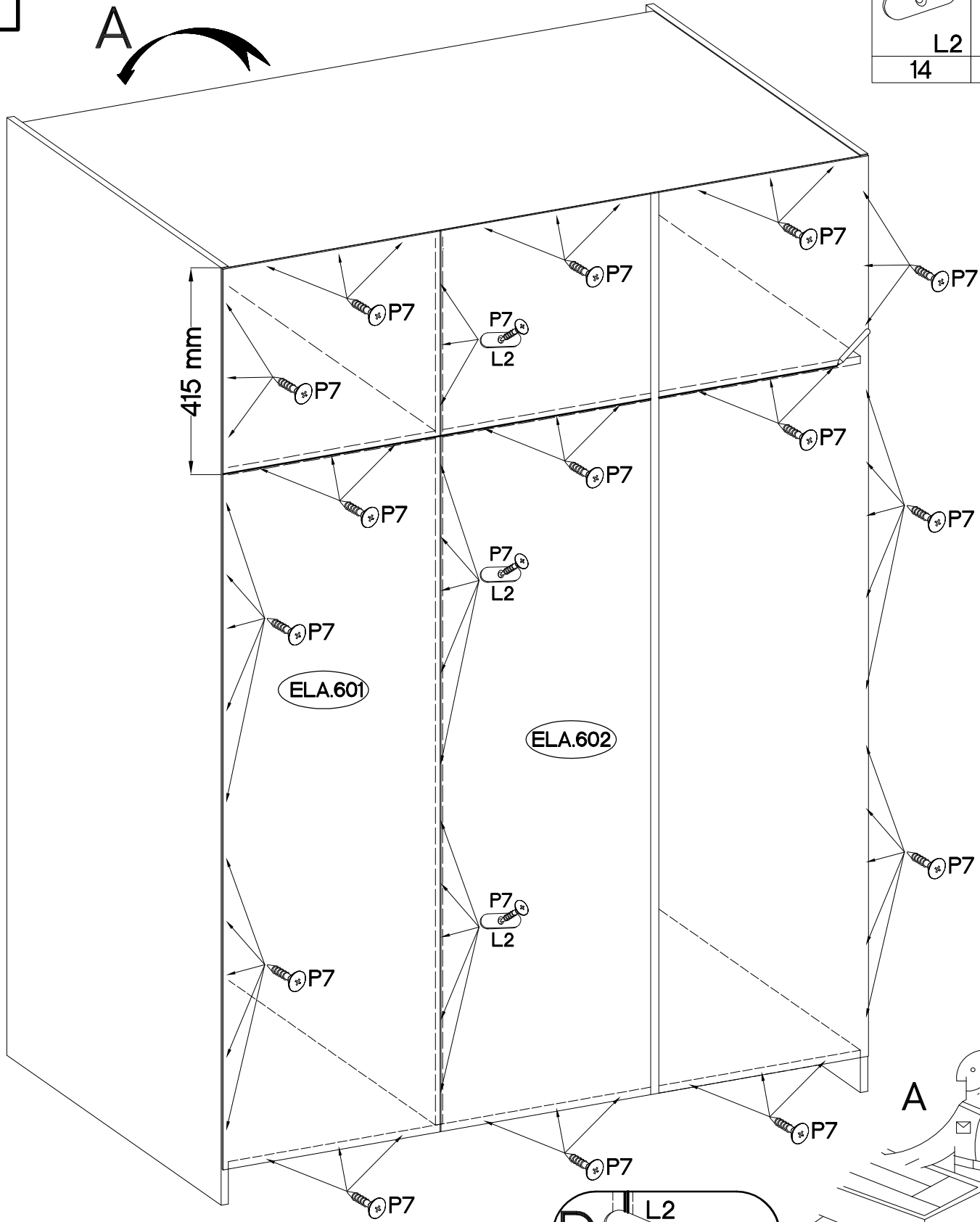
	†3.0x20mm
L2	P7
14	66



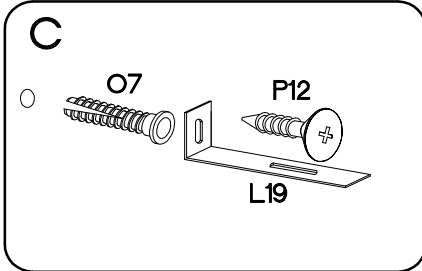
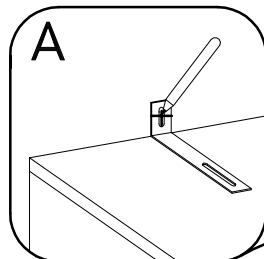
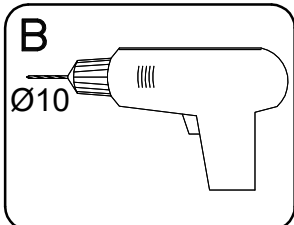

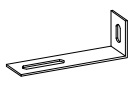

5

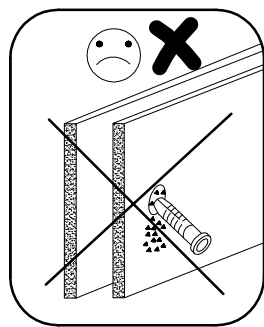
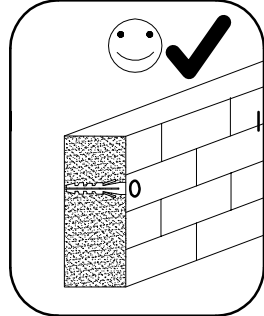
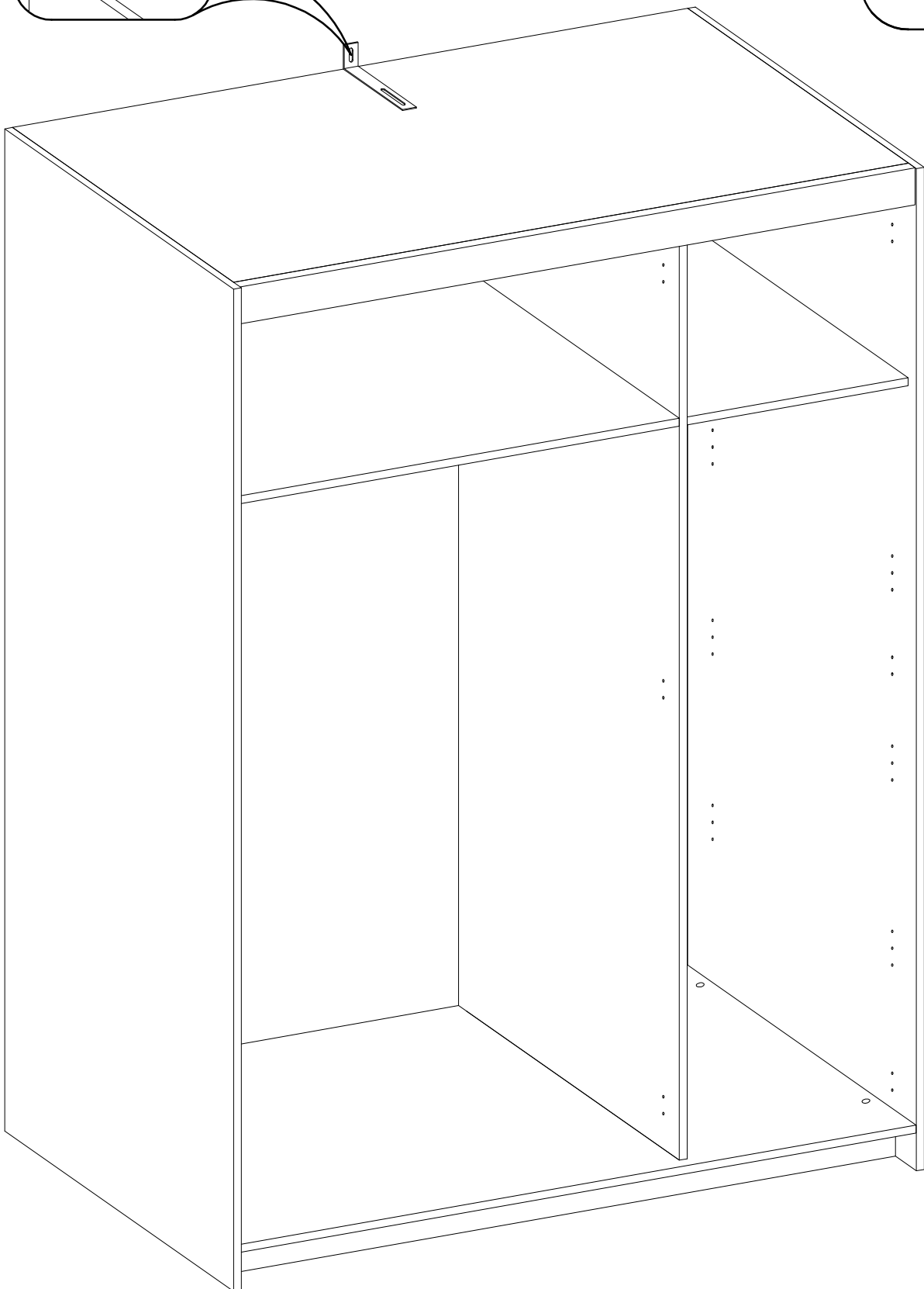
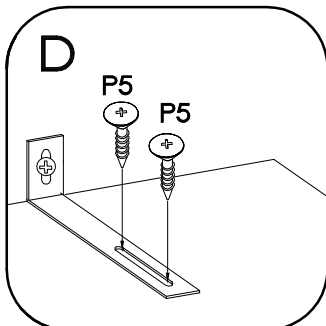



±5.0x60mm	±10x50mm	±3.5x13mm
		
<b>P12</b>	<b>O7</b>	<b>L19</b>
1	1	1

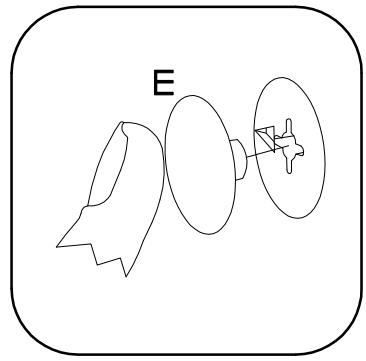
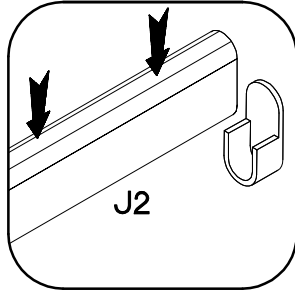
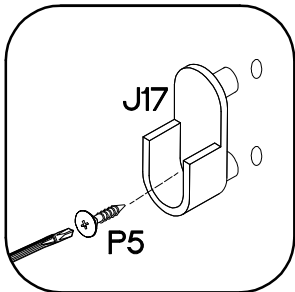
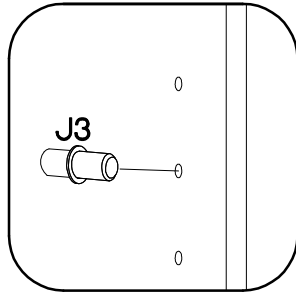
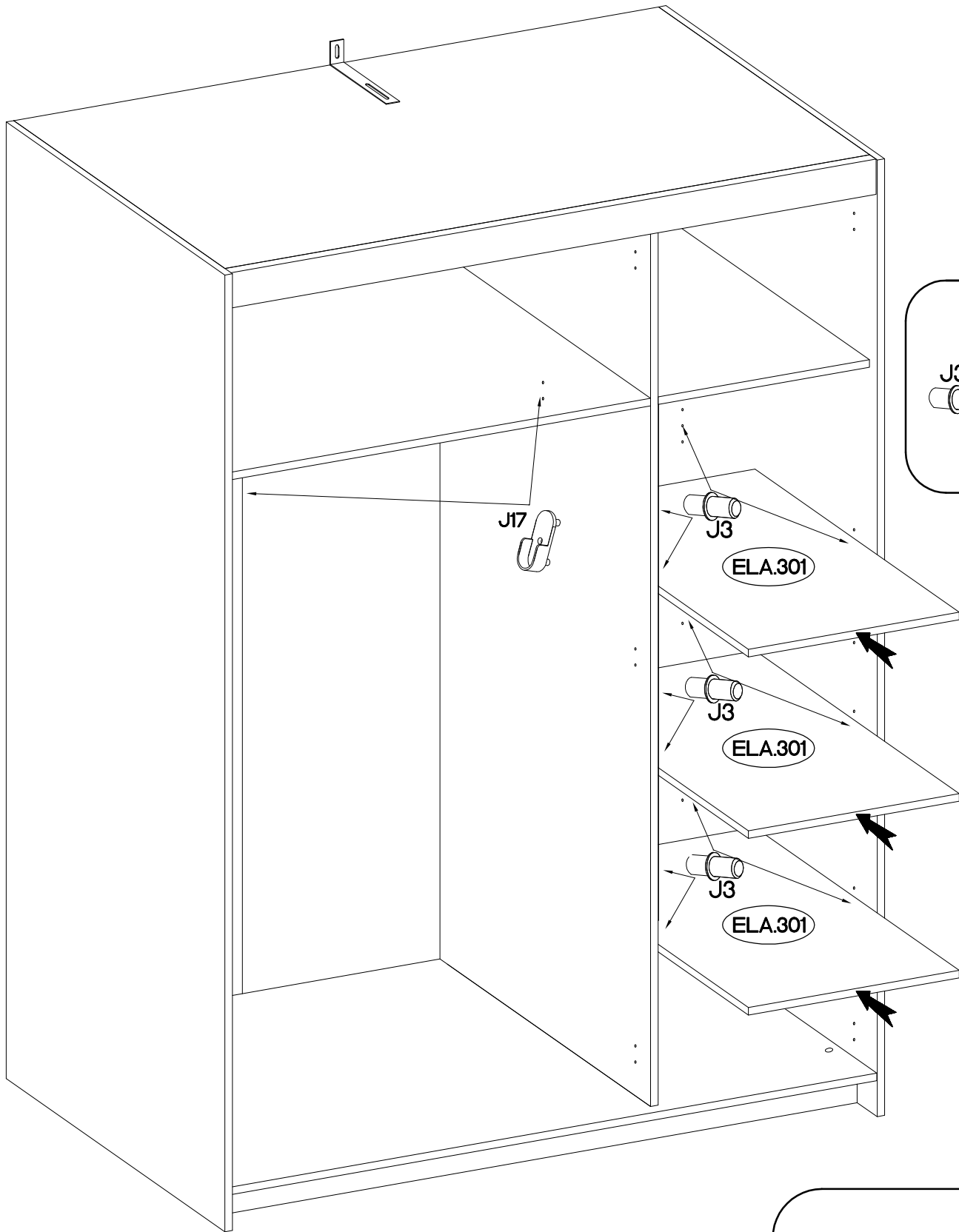

 P5	 J2	 J17	 J3	 E
2	1	2	12	20



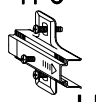

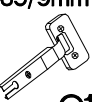
7

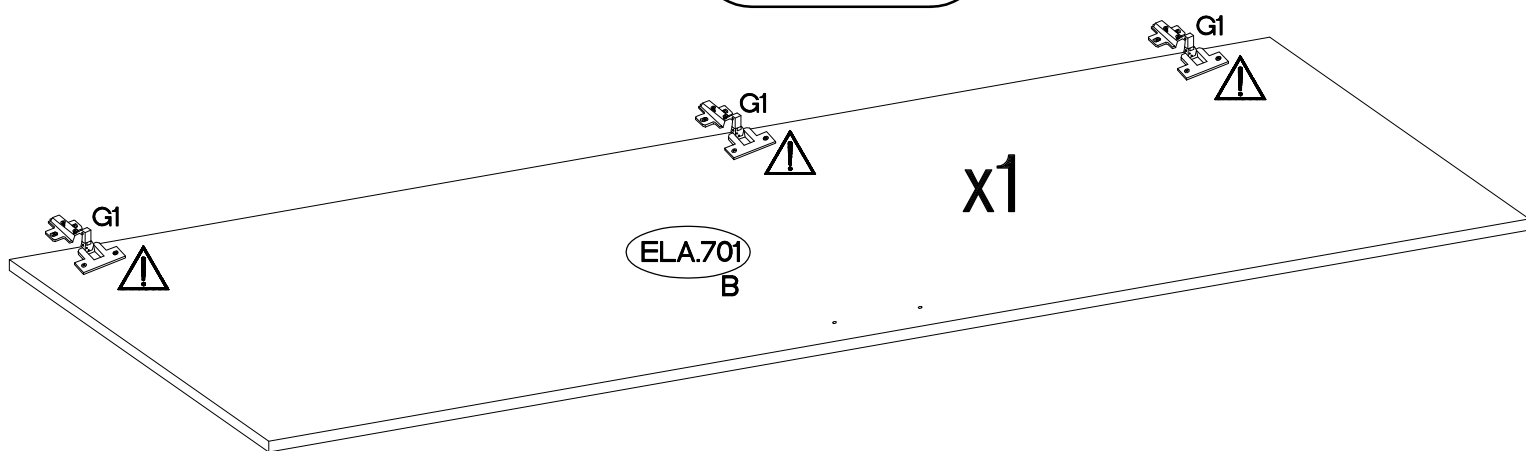
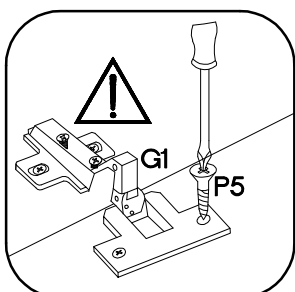
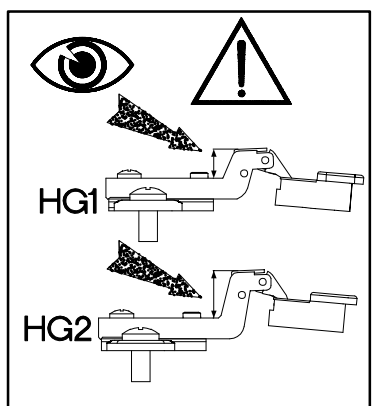
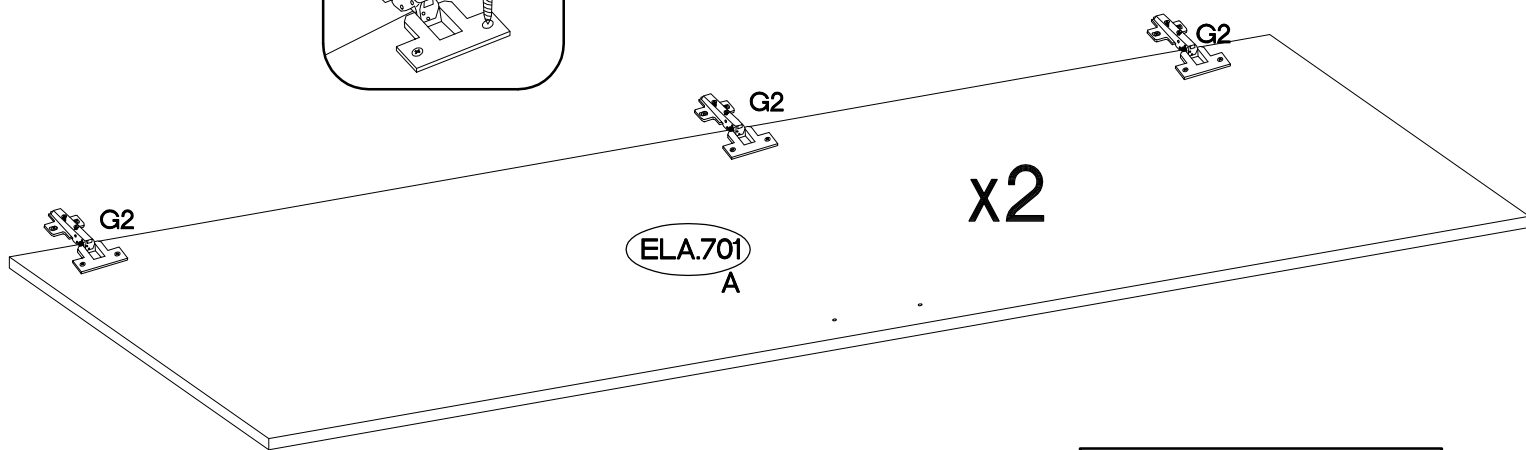
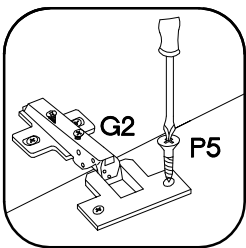
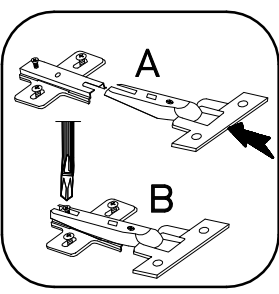
±35/16mm	H=0	±3.5x13mm	±35/9mm
			
G2	H	P5	G1
6	9	18	3

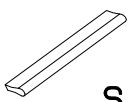

8

L=128mm	4.0x30mm
	
S	R2
3	6

