

POSSINA

BARON 3S Sofa Bed Assembly Instruction

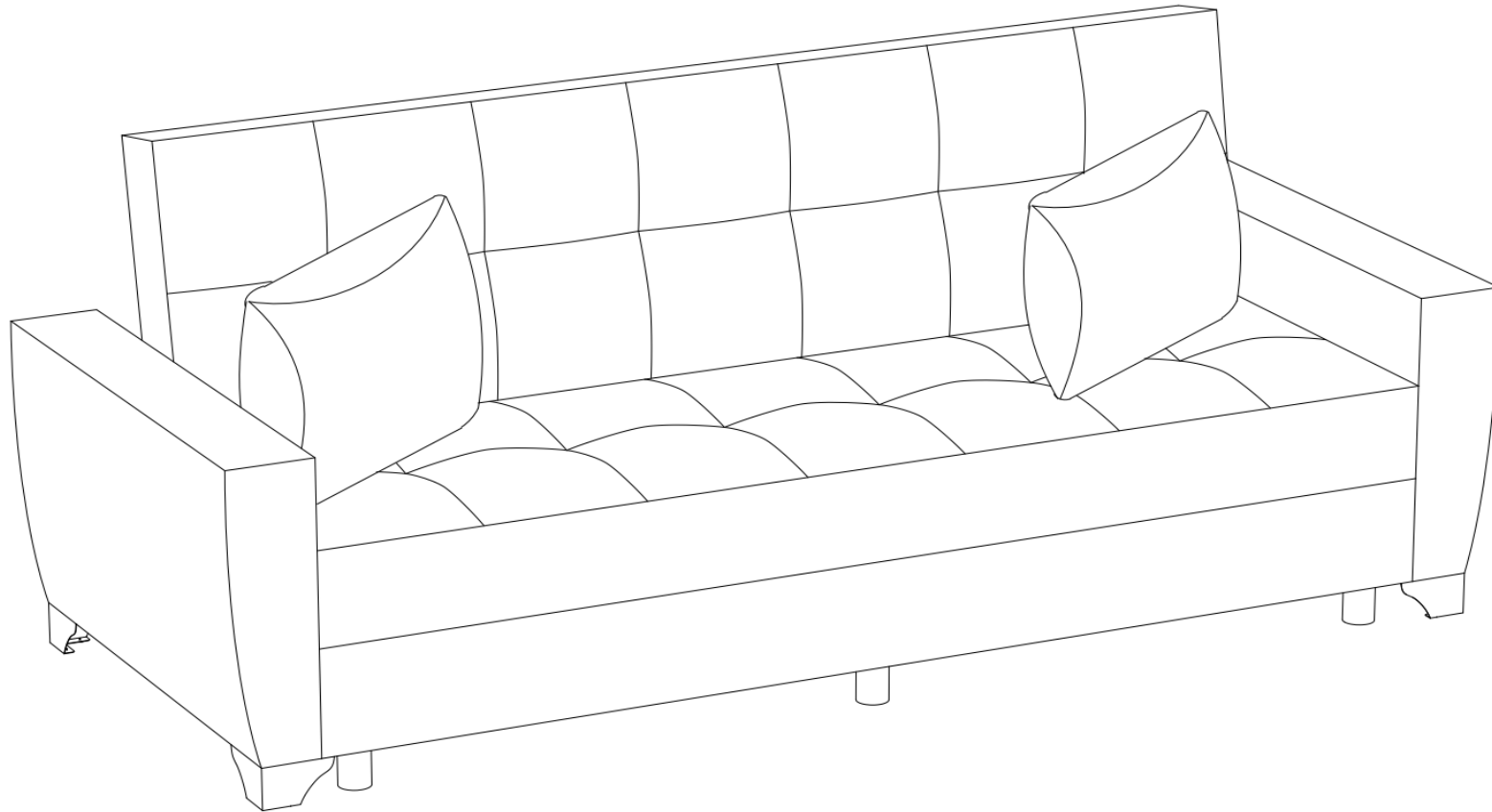

1. Two or more people are required for assembly.
2. To avoid squeaking, please tighten the bolts all the way. An electric drill is recommended for the assembly.
3. Professional installation is highly recommended.

Accessories List

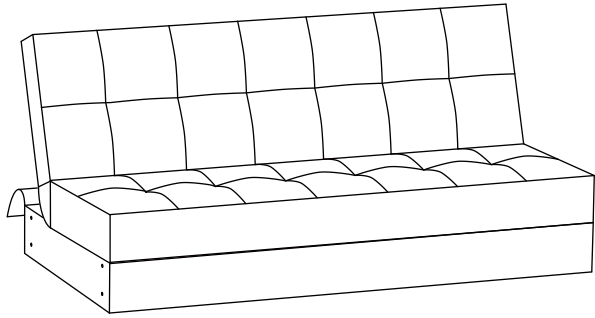

①×1

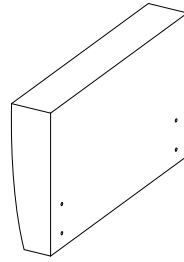

②×2

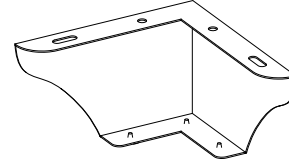

③×4

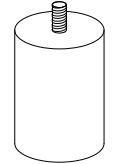

④×6

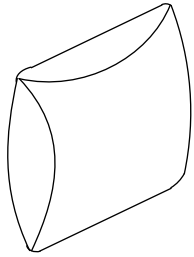

⑤×2



M4X25mm

Ⓐ×16

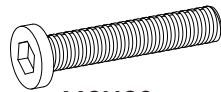

M8X60mm

Ⓑ×8



M8X15mm

Ⓒ×8



M8

Ⓓ×1

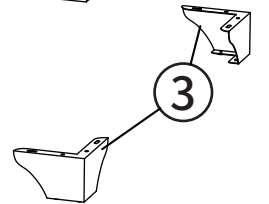
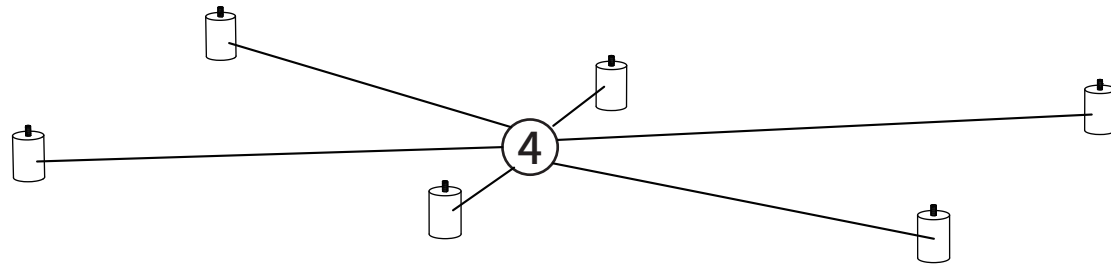
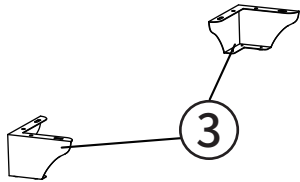
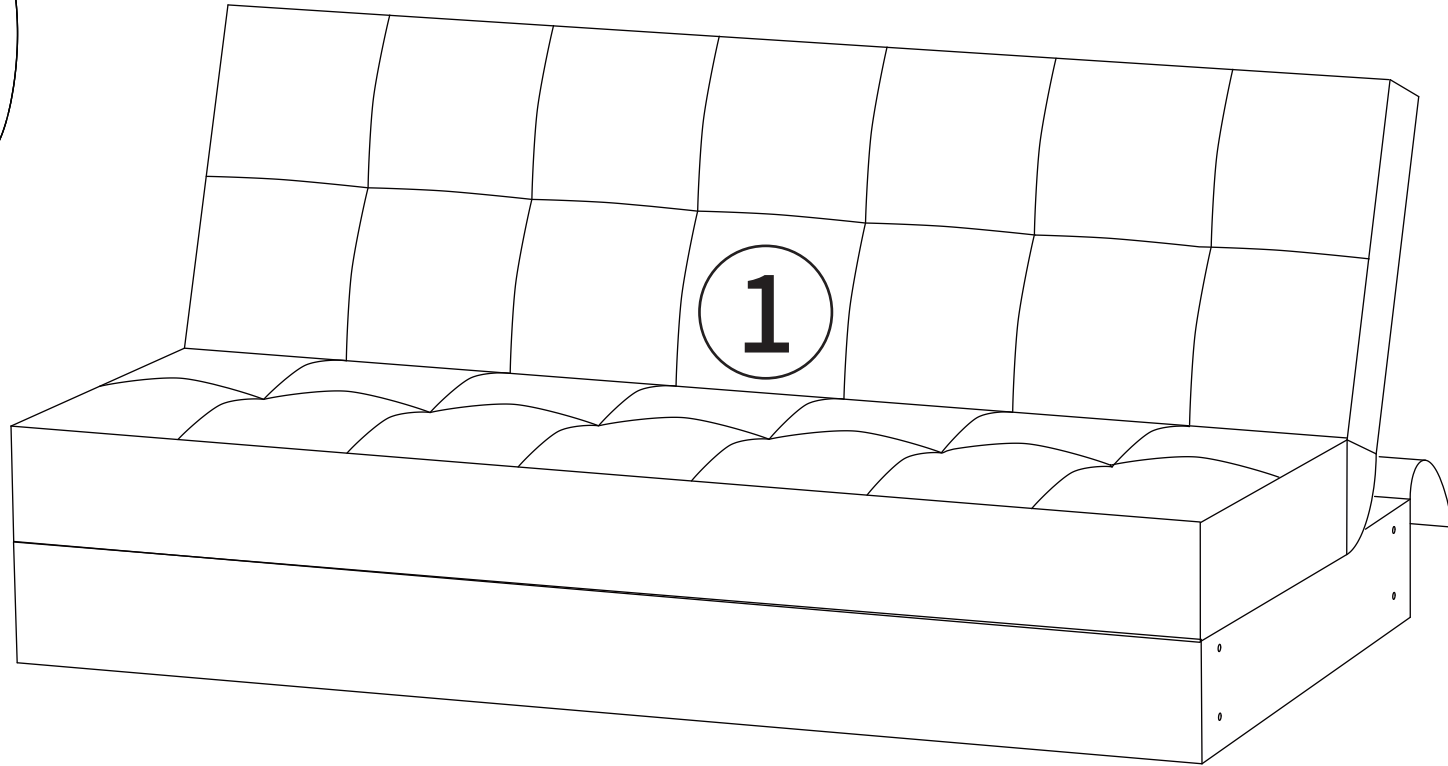
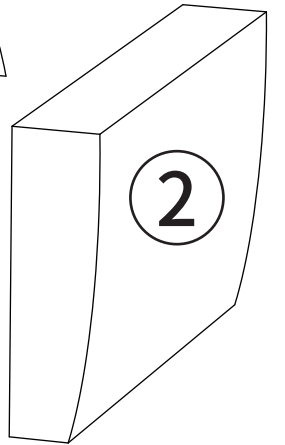
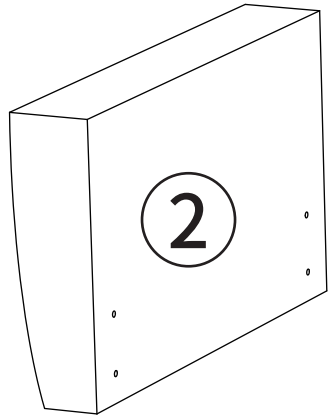
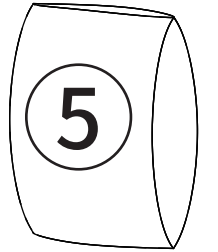
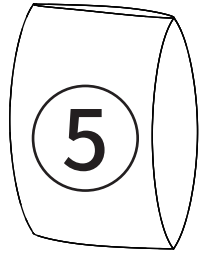

- 1** ② X2 ③ X4
 Ⓐ X16

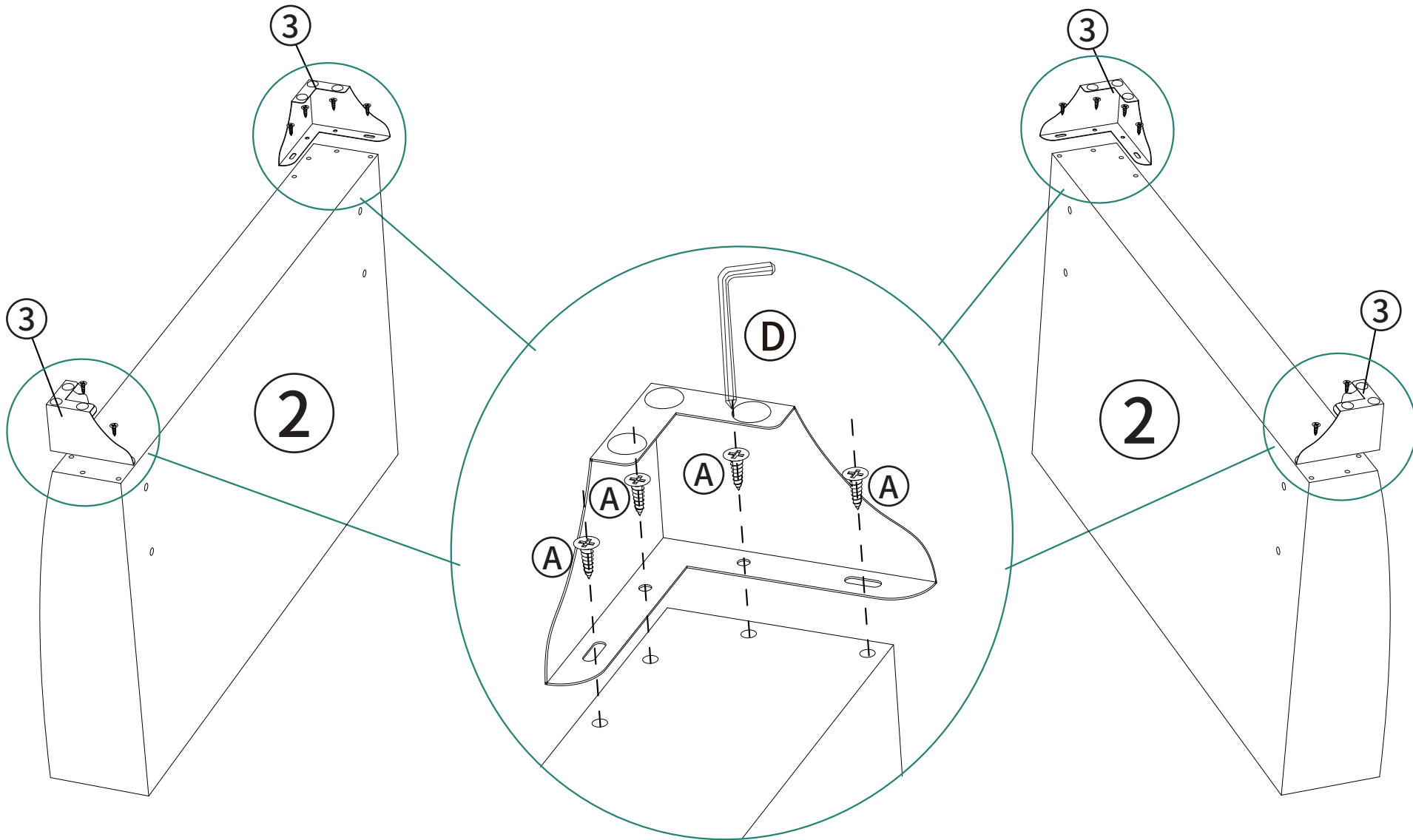

2

① X1

④ X6

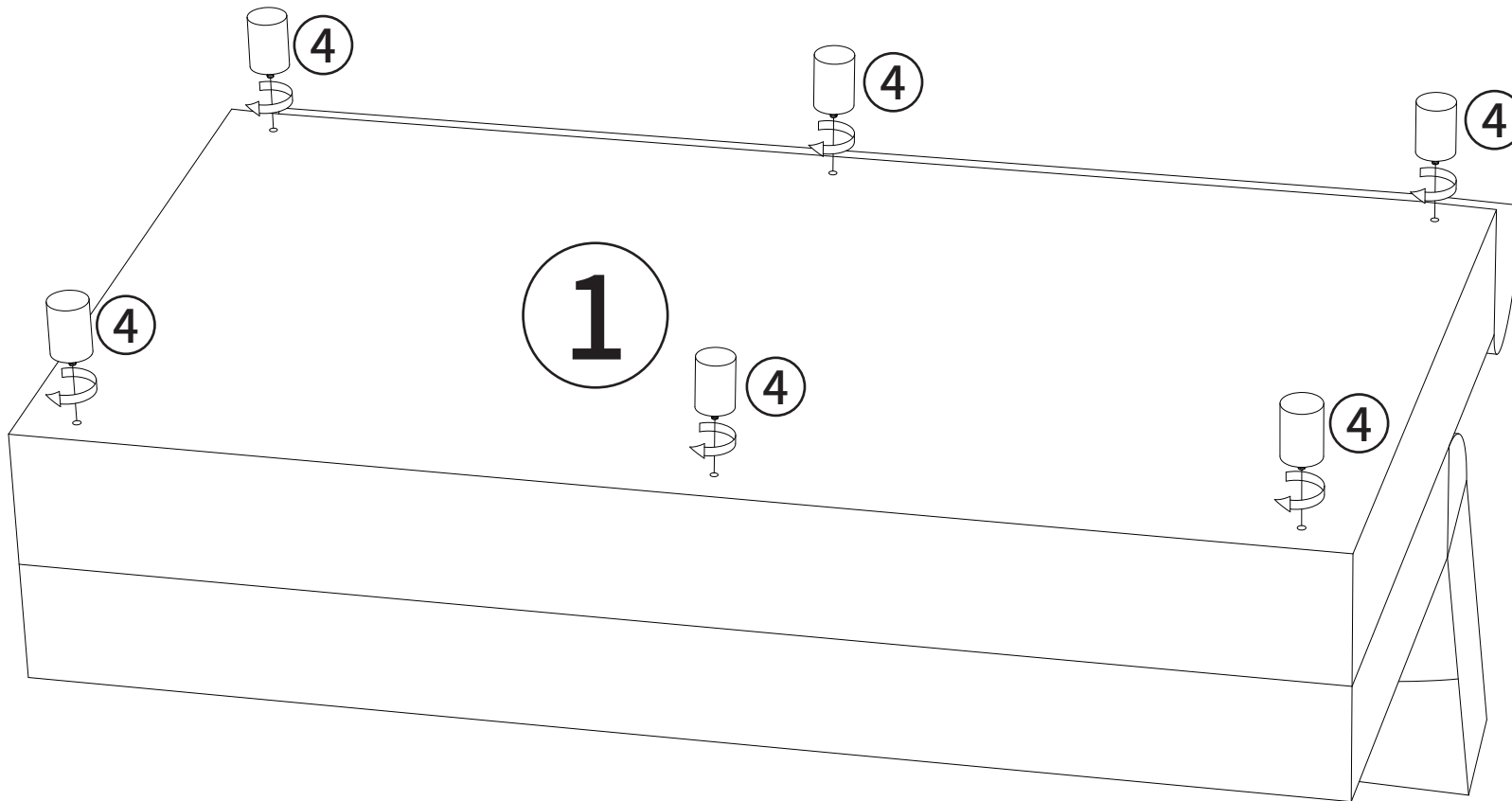

3

(B) X8

(C) X8

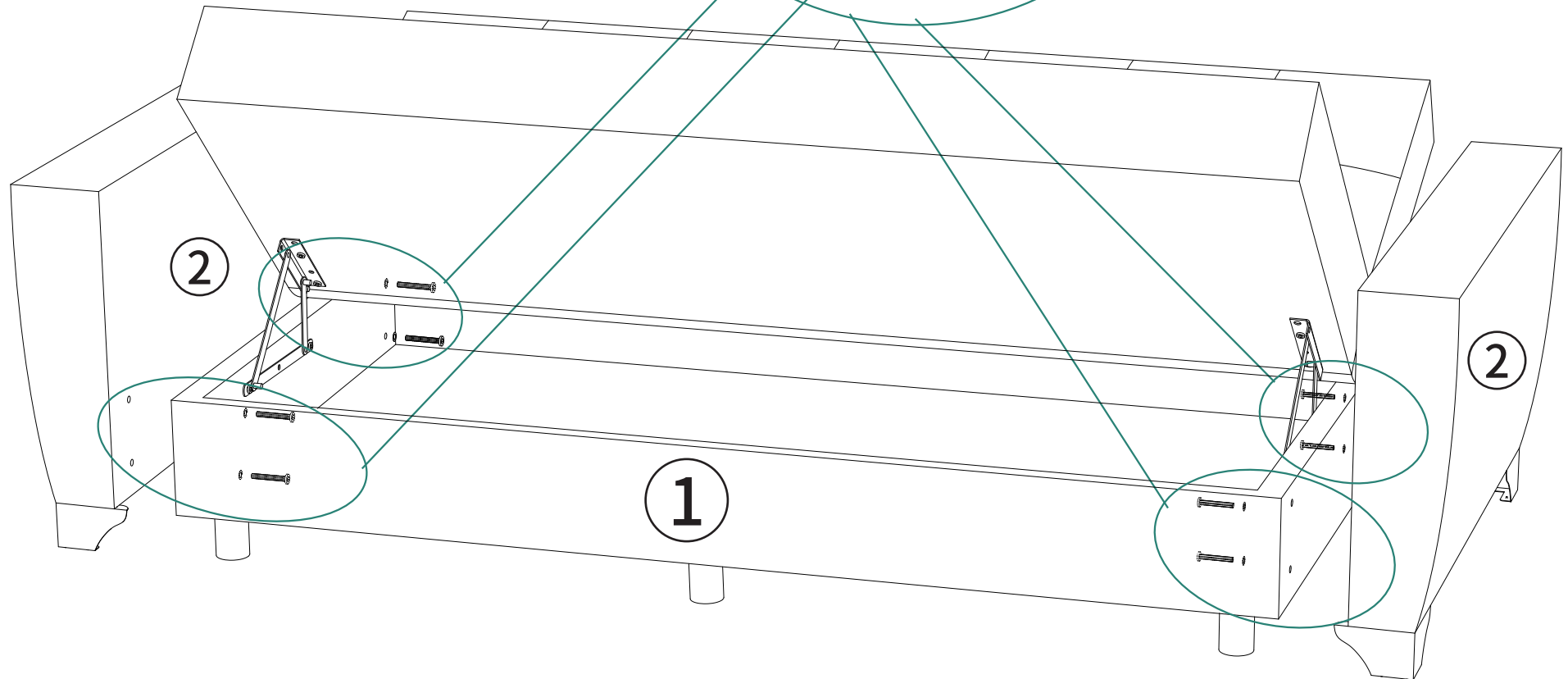
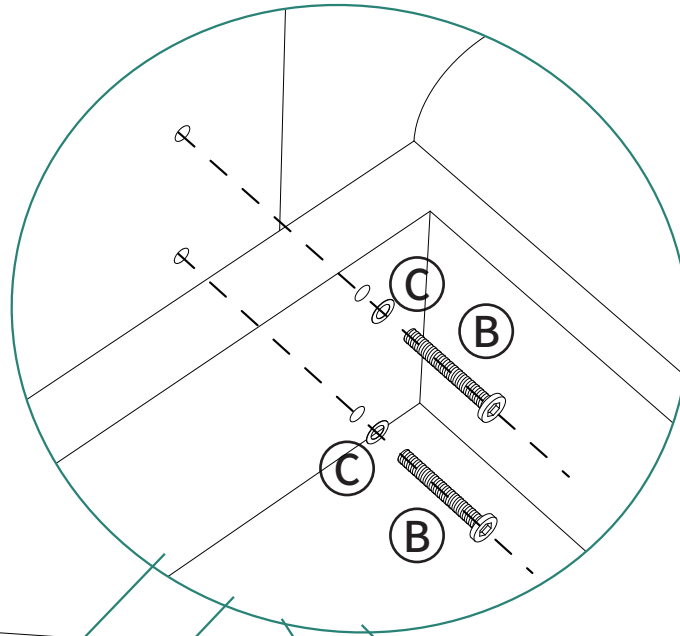

4

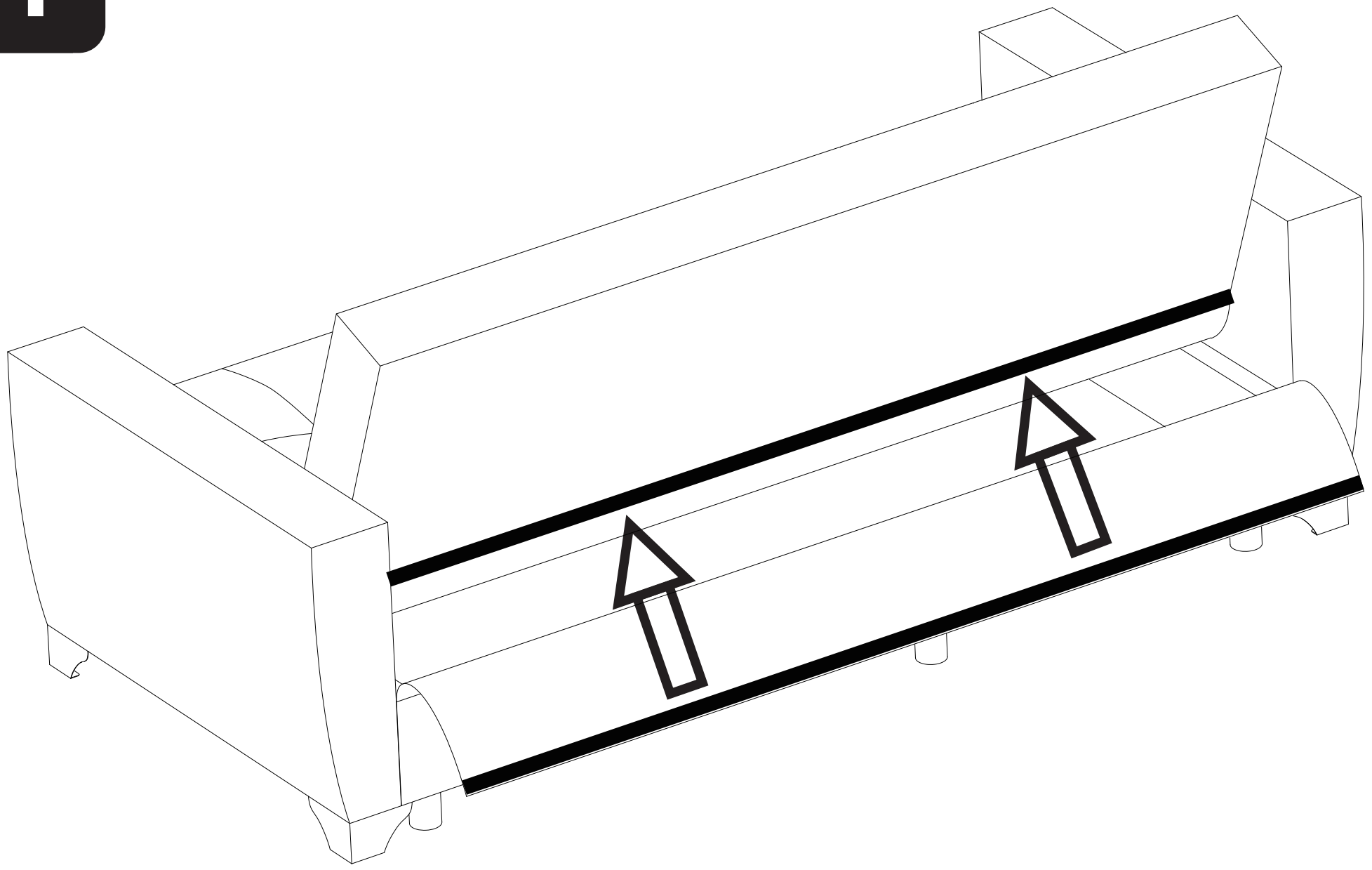

5

⑤ X2

