

240 min

ELENA 2D NAR

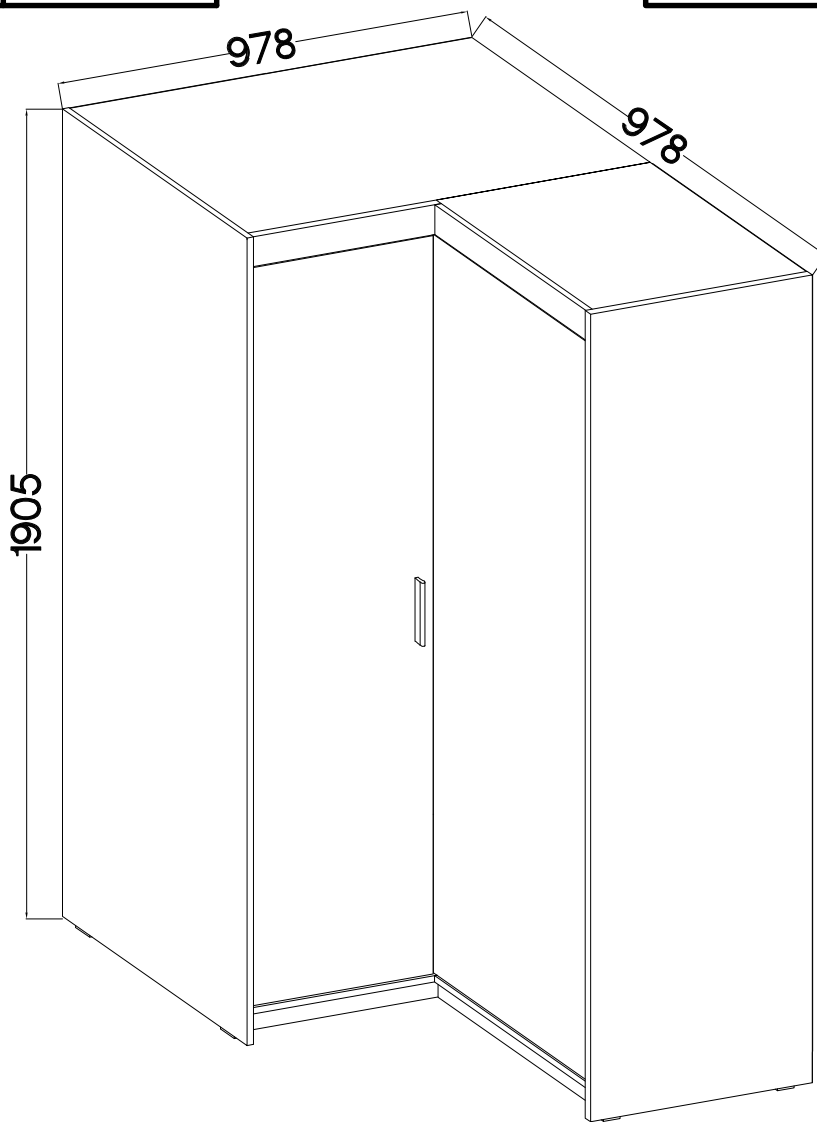
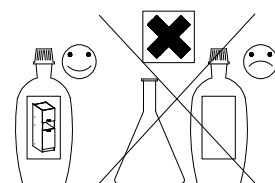

A	A2	B	C	D2	D12	E	F2	F4
48	12	6	40	22	9	15	6	3
HG11	J2	J3	J17	J59	L19	M11	O	O7
6	1	12	2	6	1	12	1	1
O11	P1	P5	P12	R2	S	T3		
1	2	126	1	2	1	1		

P-ISM-ELA-17

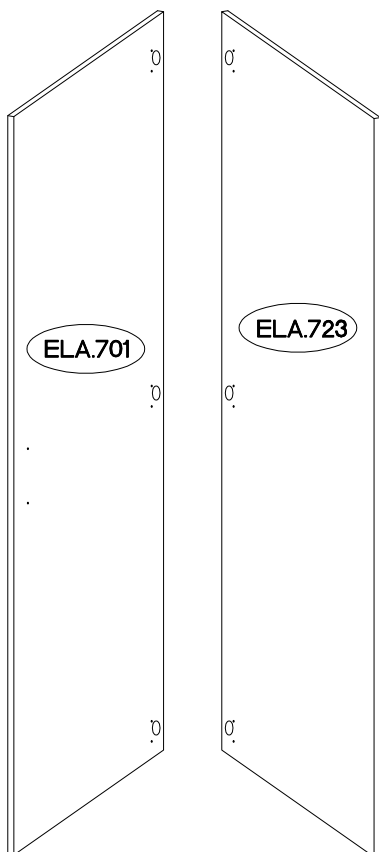
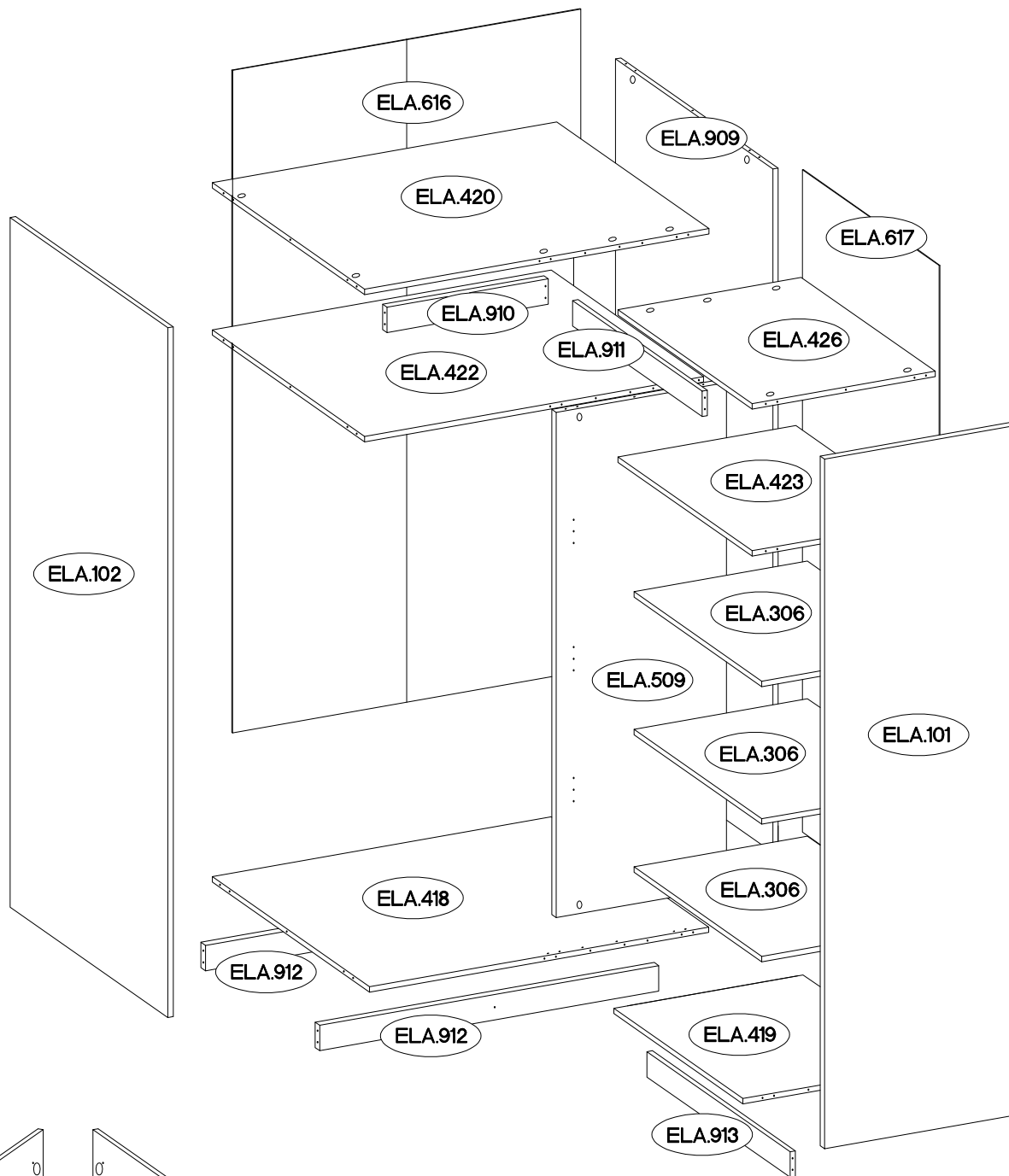

ELA.422

ELA.423



ELA.306

Colli	Ersatzteil Nummer	Dimension
Colli 3/3	ELA.509	1391.5x476x15
	ELA.616	1825x974x2,5
	ELA.617	1825x460x2,5
	ELA.701	1737x430x15
	ELA.723	1737x438x15



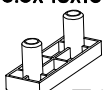

Colli	Ersatzteil Nummer	Dimension
Colli 1/3	ELA.306 x3	433x485x15
	ELA.418	948x529x15
	ELA.419	434x529x15
	ELA.420	963x512x15
	ELA.426	451x512x15
	ELA.422	948x512x15
	ELA.423	451x497x15
	ELA.910	451x70x15
	ELA.911	435x70x15
	ELA.912 x2	948x70x15
	ELA.913	481x70x15

Colli	Ersatzteil Nummer	Dimension
Colli 2/3	ELA.101	1900x530x15
	ELA.102	1900x530x15
	ELA.909	1883x529x15

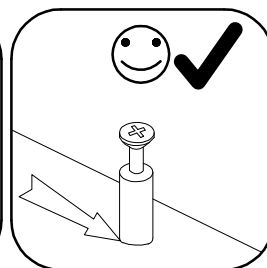
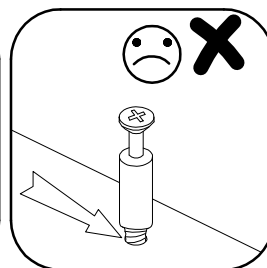
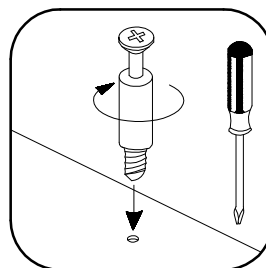
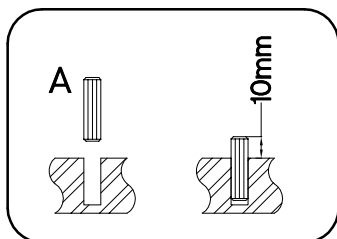
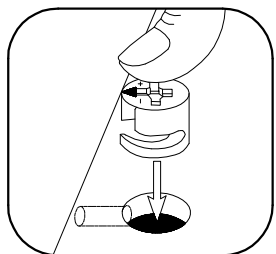
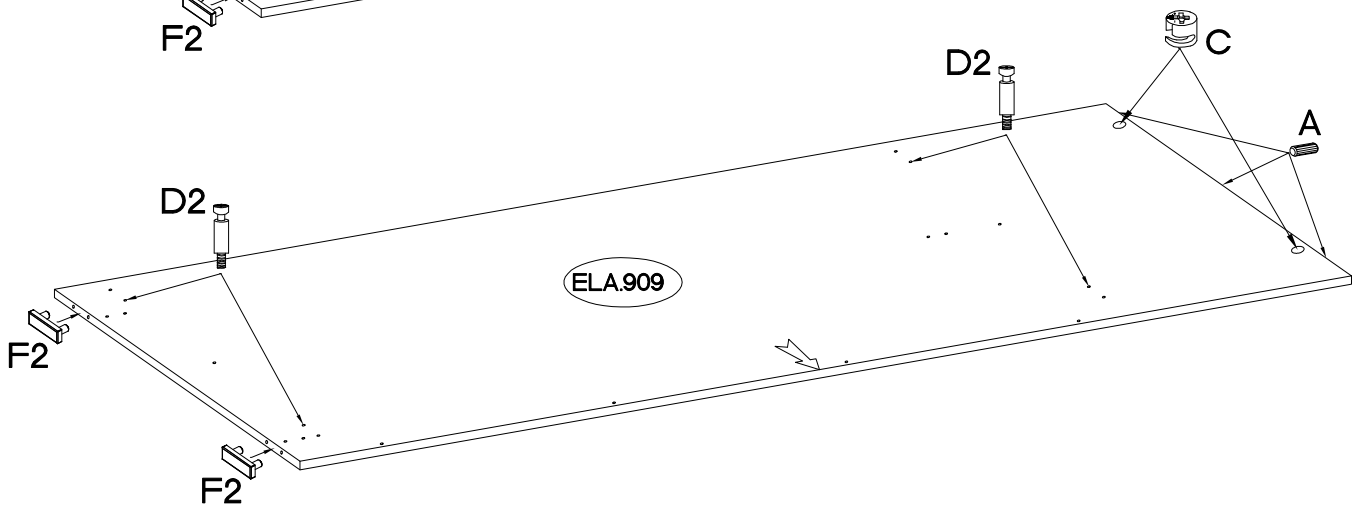
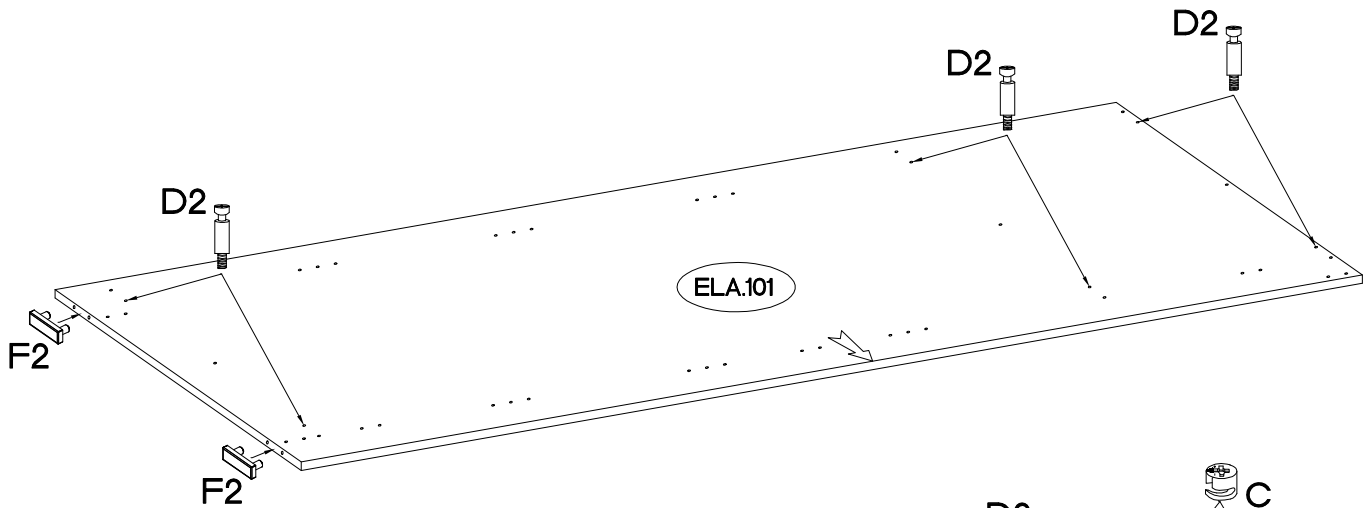
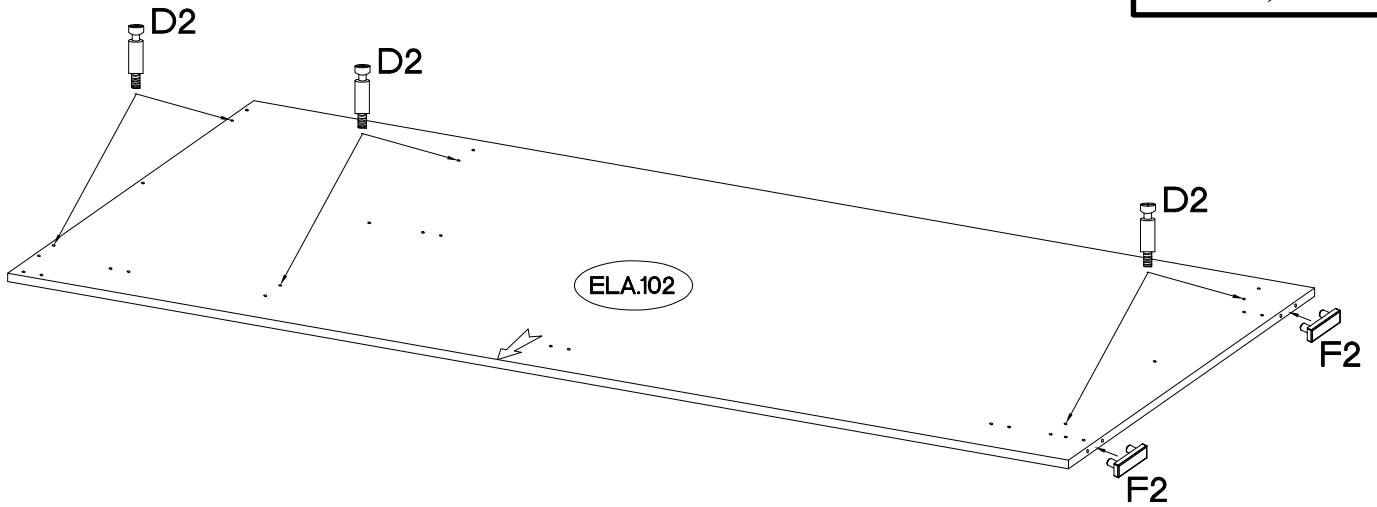
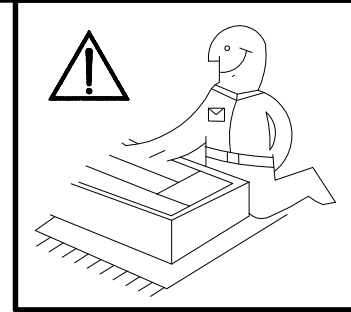
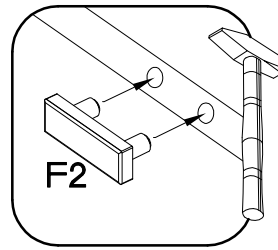

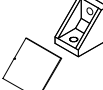

1

$\varnothing 8 \times 30 \text{mm}$  A 3	$\varnothing 15/12 \text{mm}$  C 2	L=20mm  D2 16	6.5x48x16  F2 6
---	---	--	--

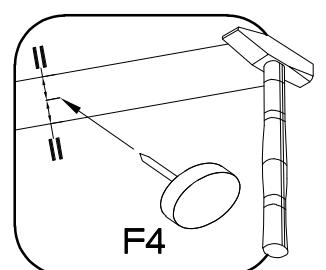
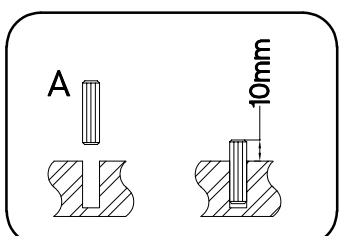
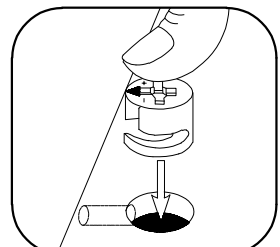
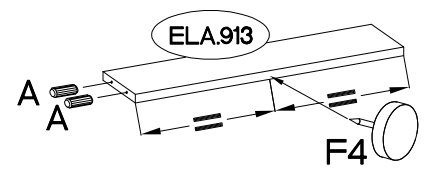
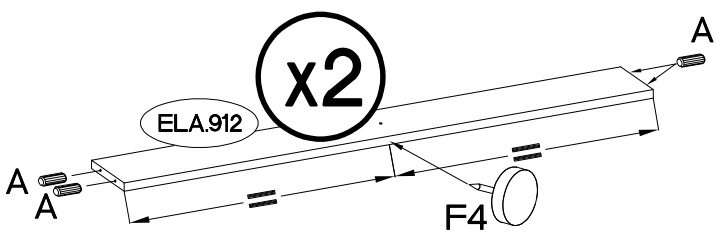
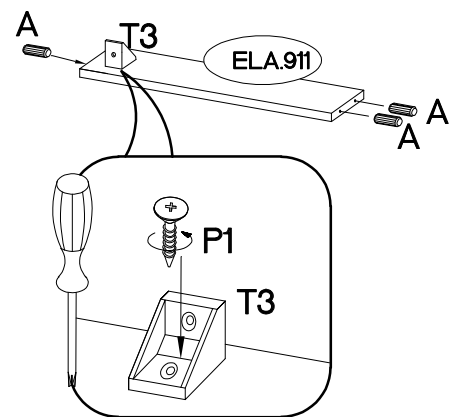
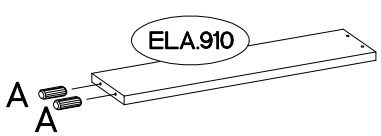
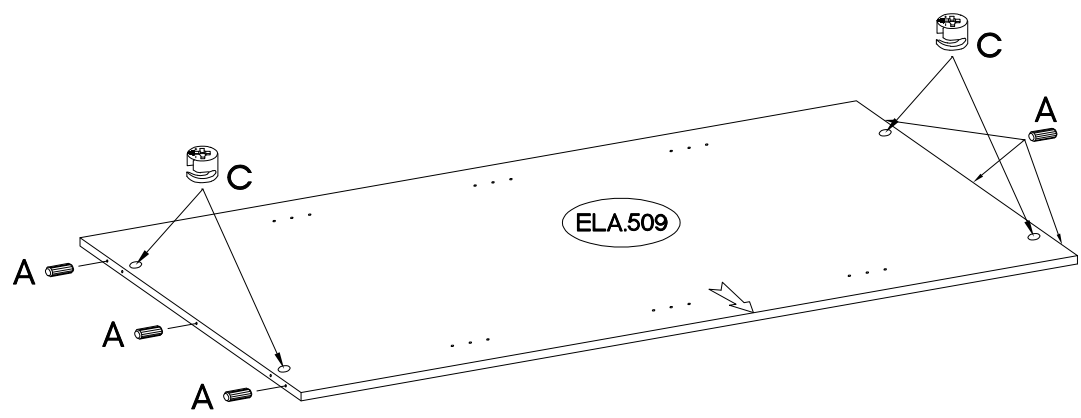
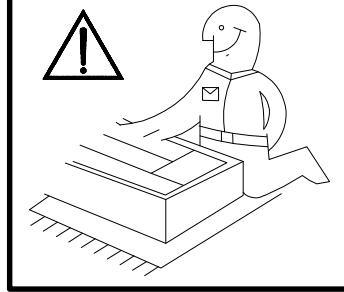

±8x30mm	±15/12mm	±15x5mm	±4.0x16mm	
				
A	C	F4	P1	T3
21	4	3	1	1



$\pm 8 \times 30 \text{mm}$  A 24	$\pm 8 \times 60 \text{mm}$  A2 12	$\pm 15 / 12 \text{mm}$  C 34	0,05  O11 1
--	---	--	--

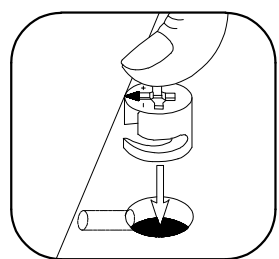
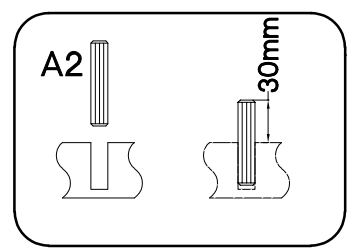
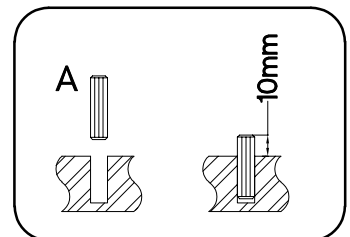
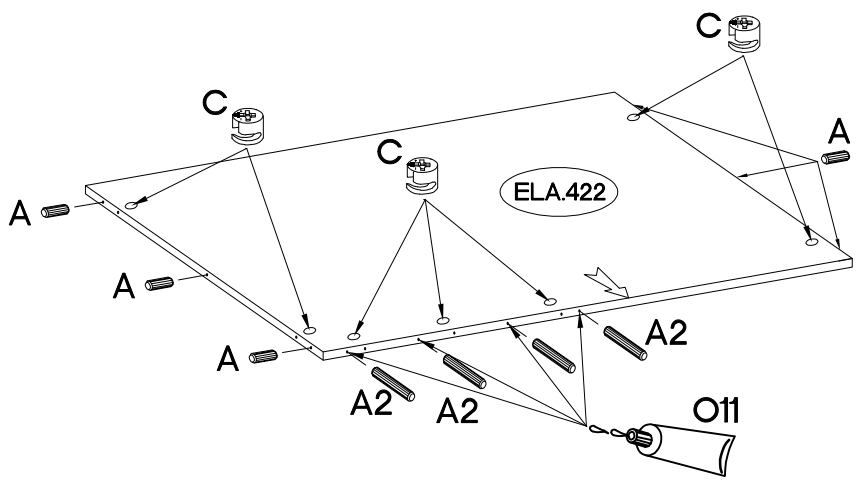
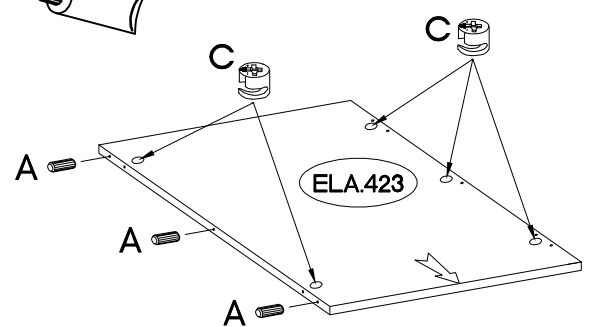
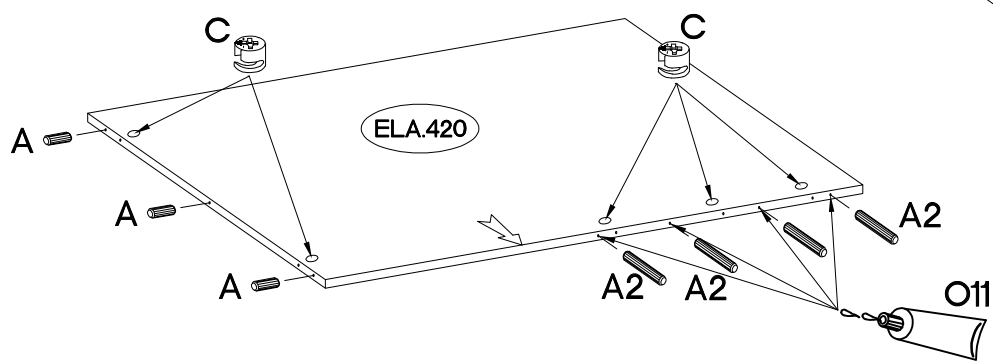
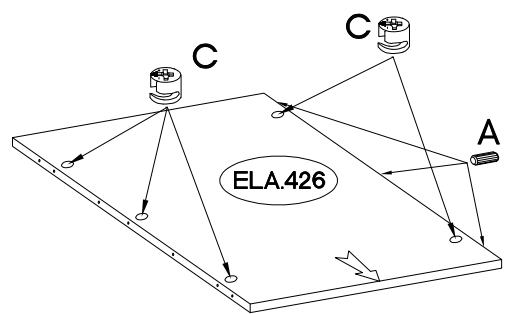
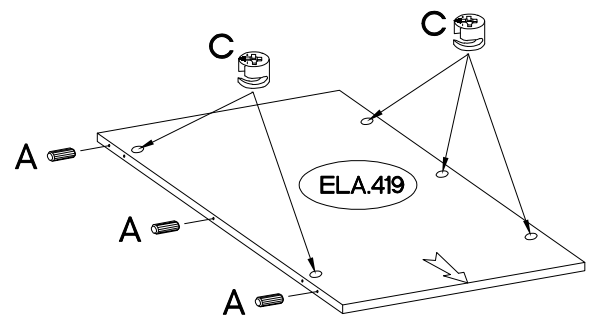
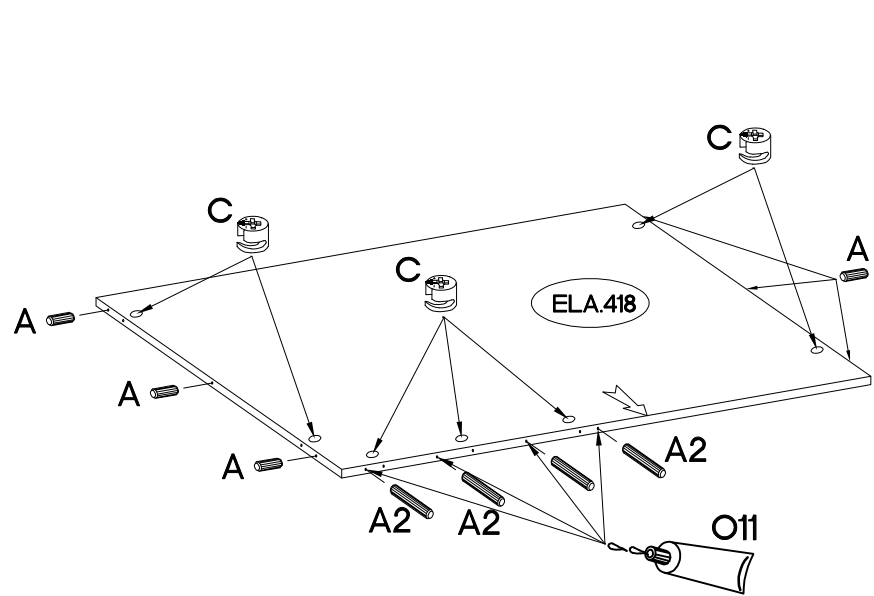
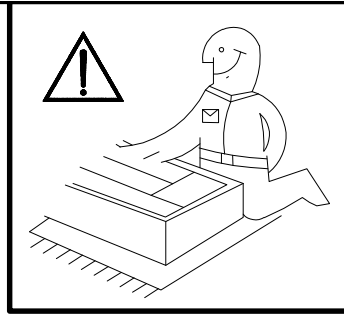

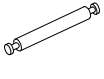

4

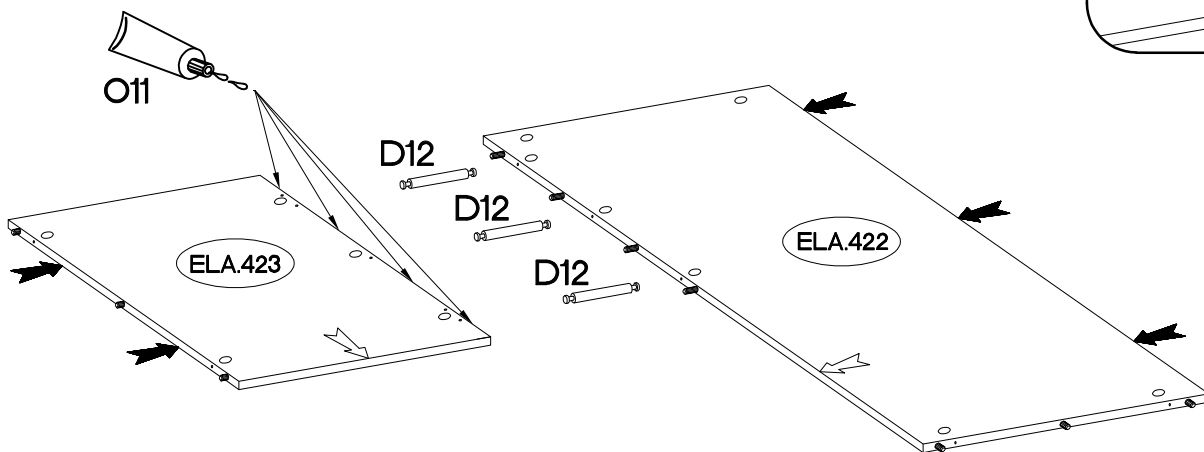
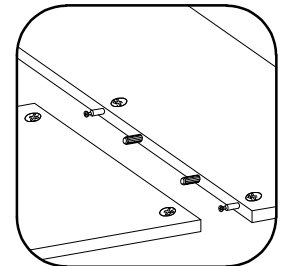
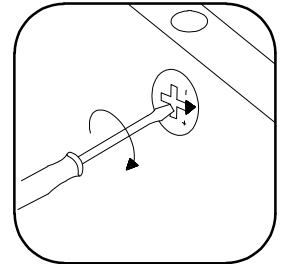
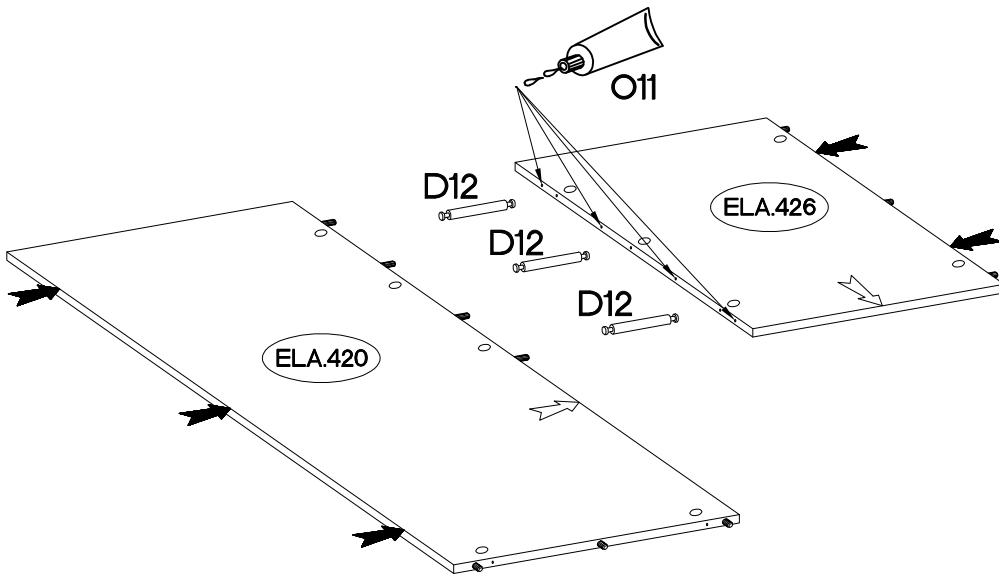
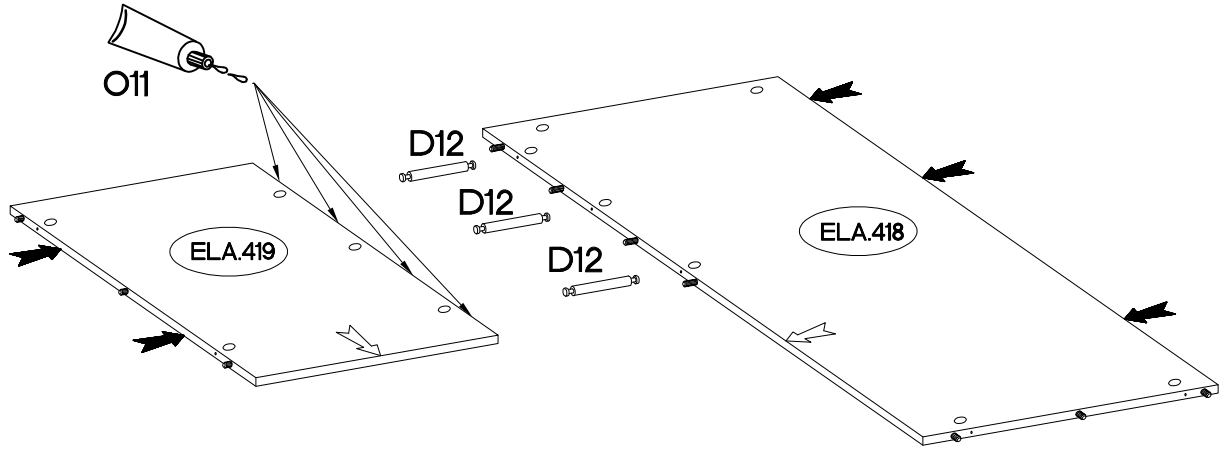
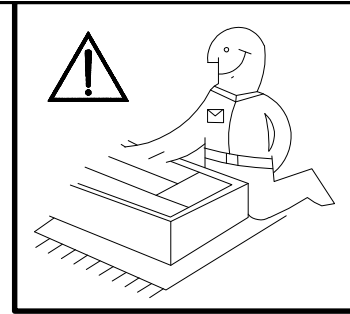
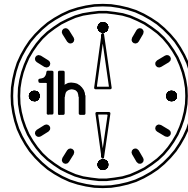
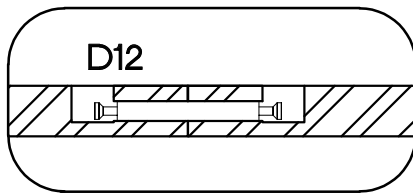
0,05  O11 1	L=40mm  D12 9
--	--

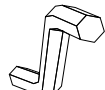

5

L=20mm  D2 6	6,4 x 50mm  B 1	 O 1
---	--	--

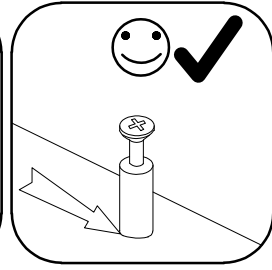
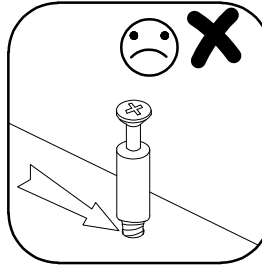
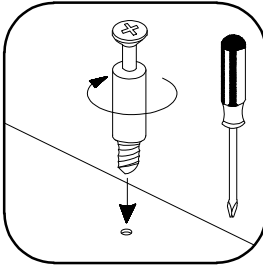
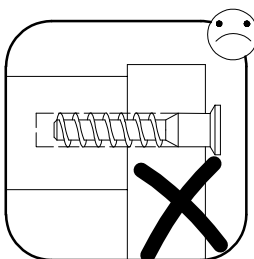
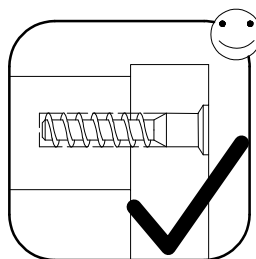
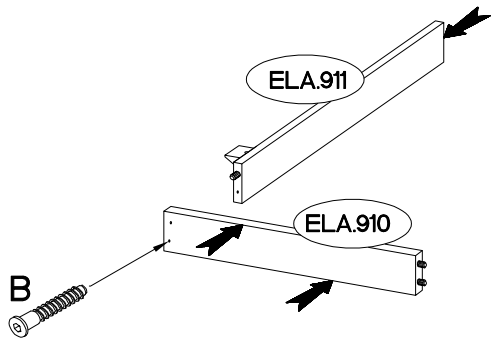
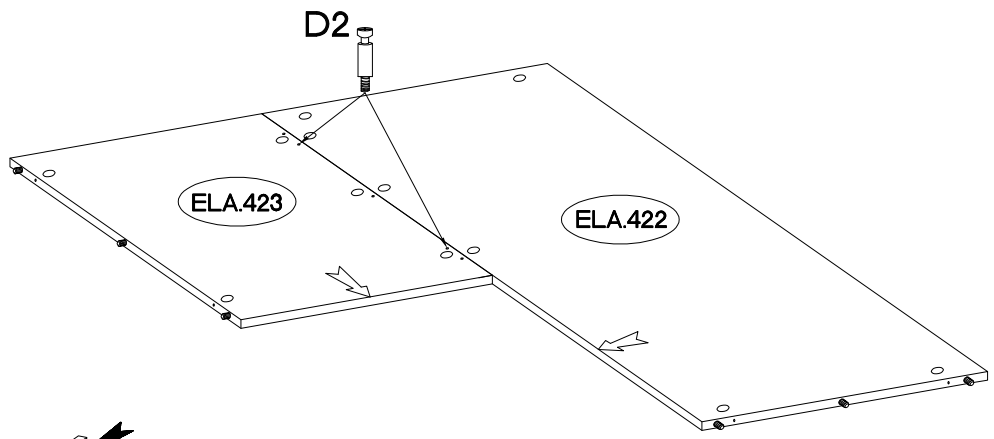
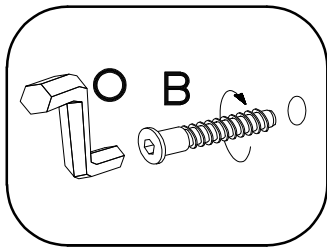
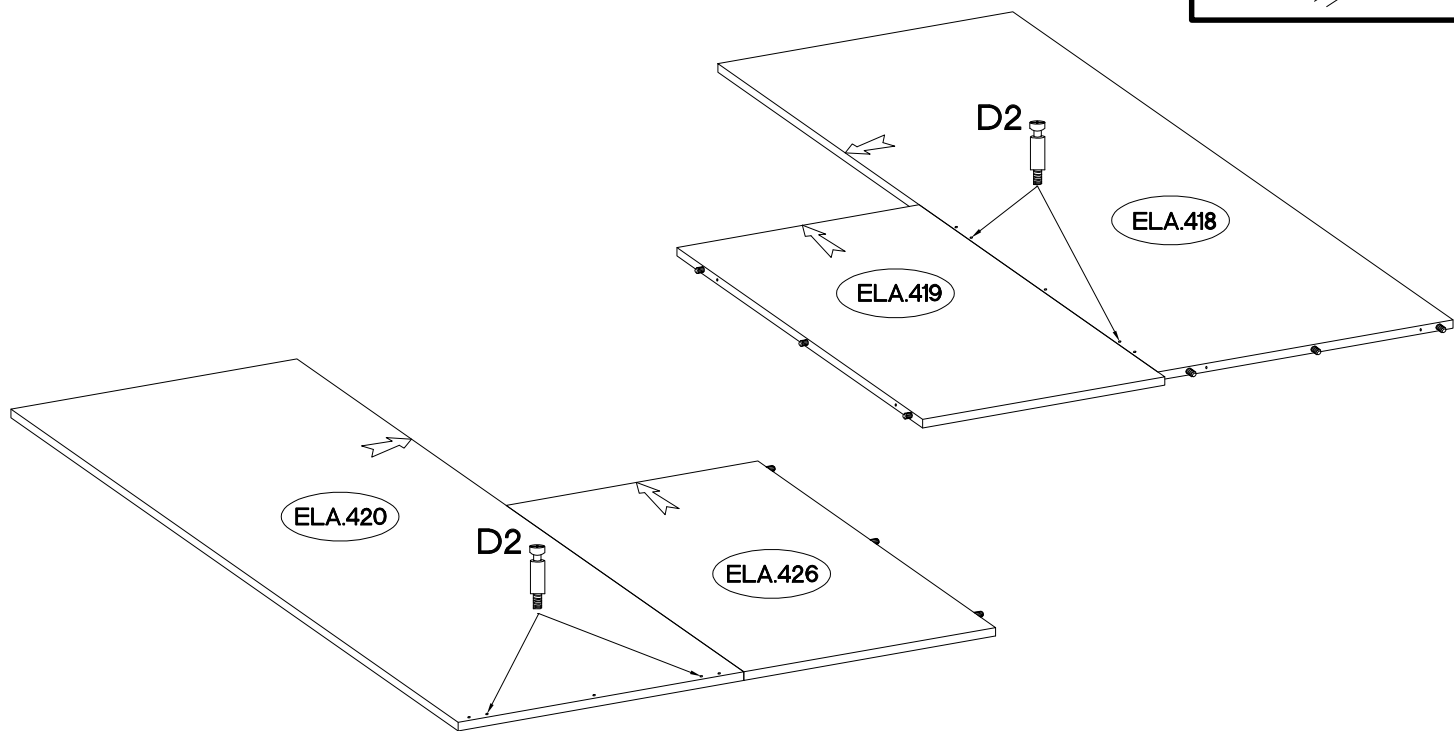
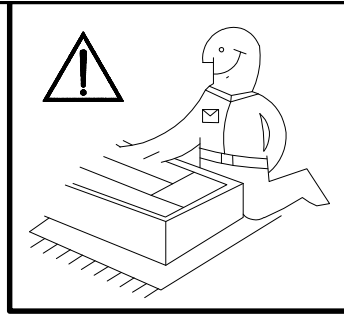

6

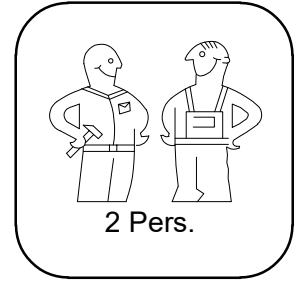
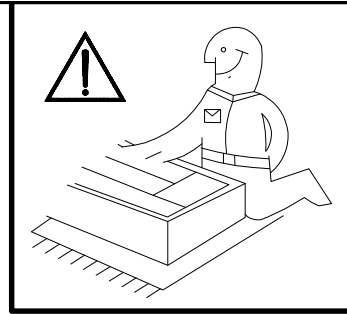
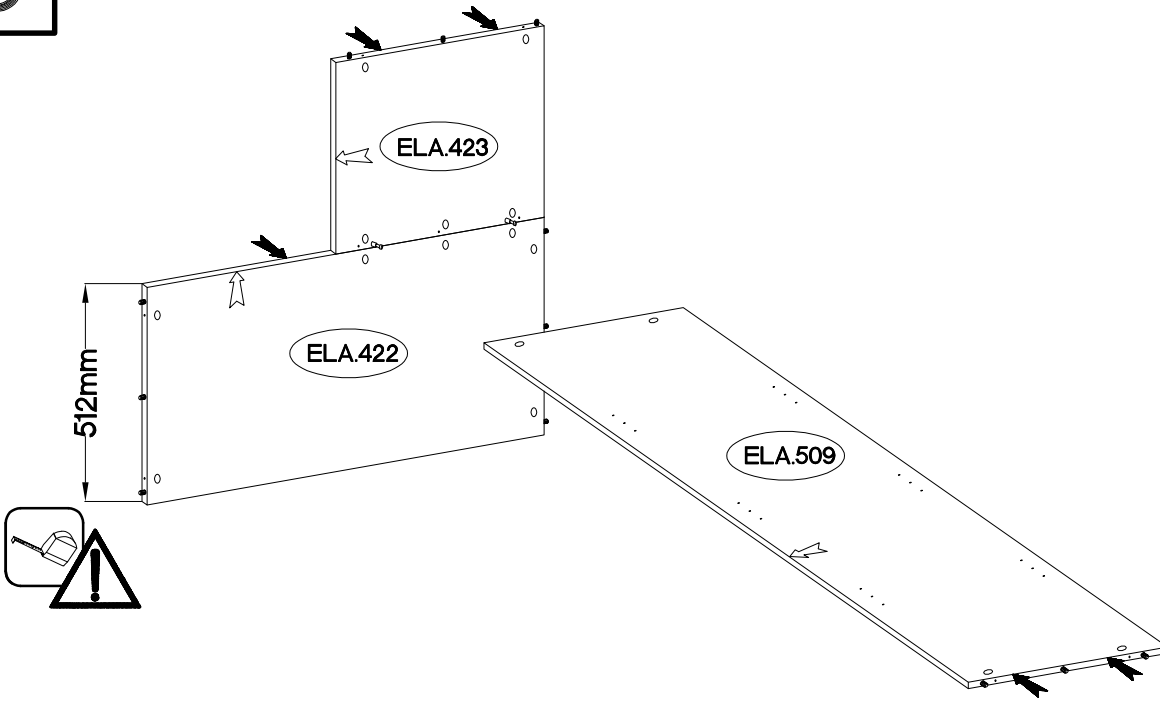

7

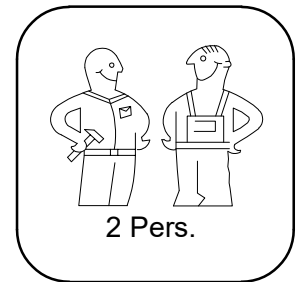
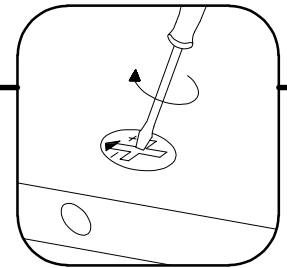
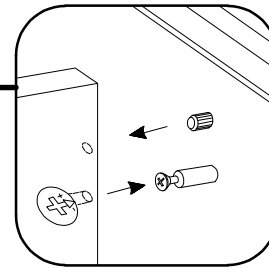
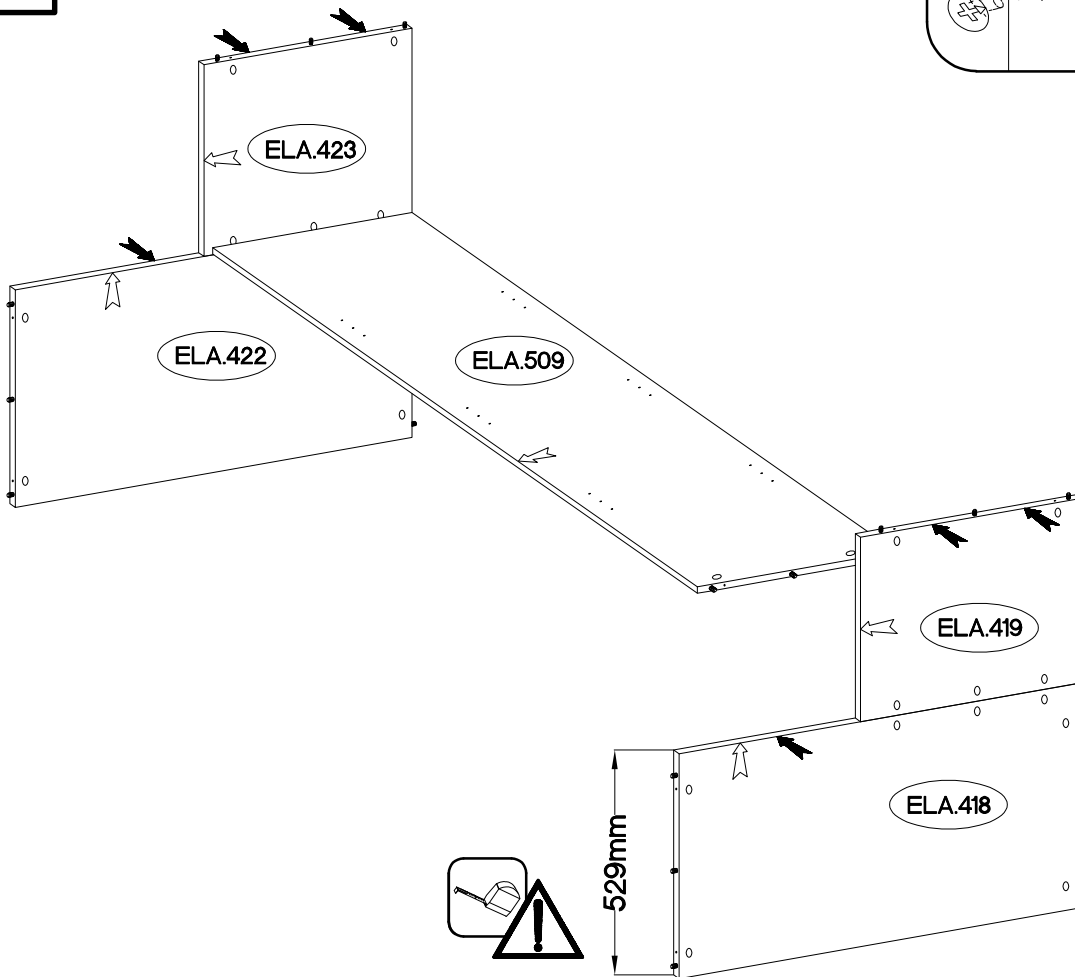

8

6,4 x 50mm

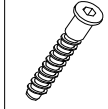

B

4

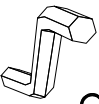

O

1

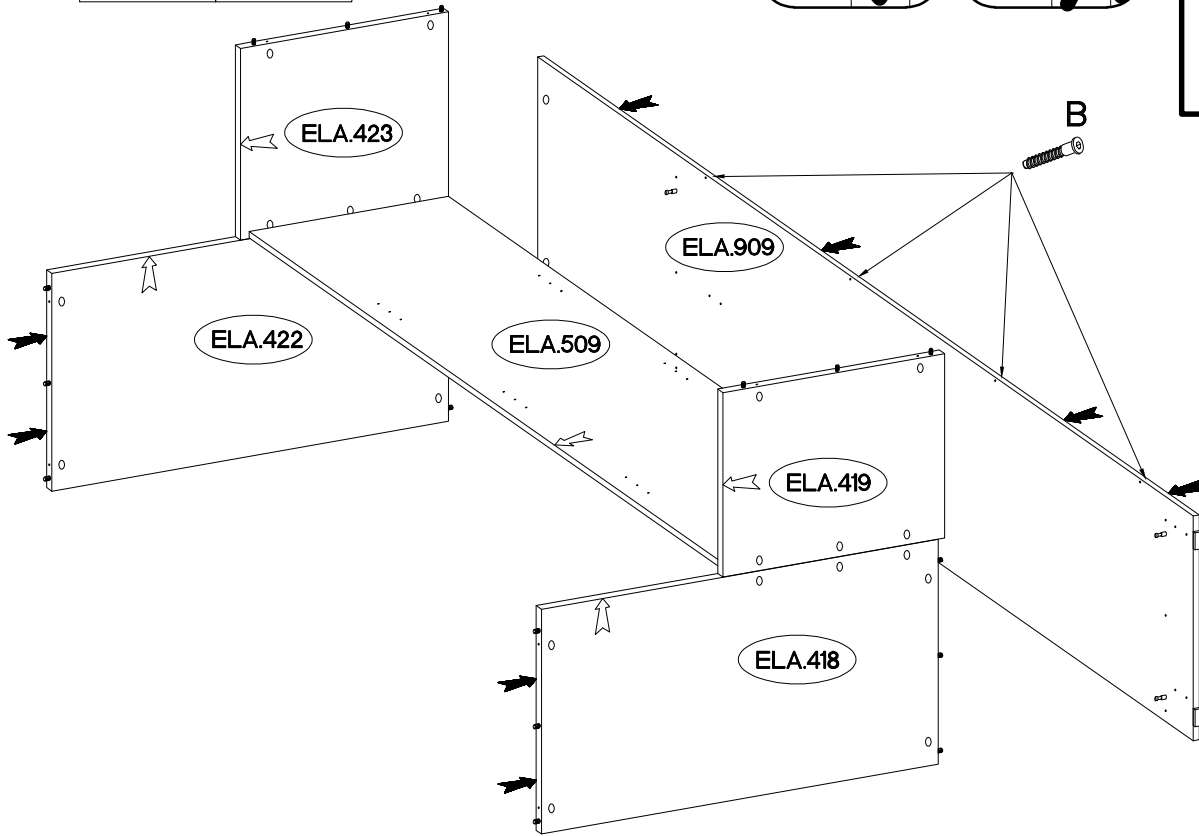
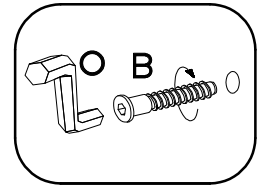
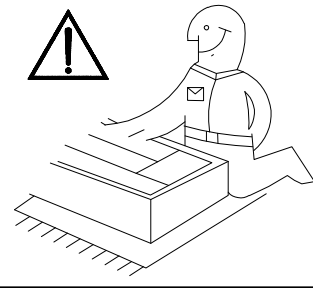
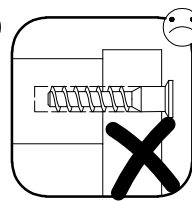
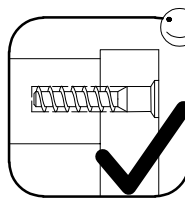

9

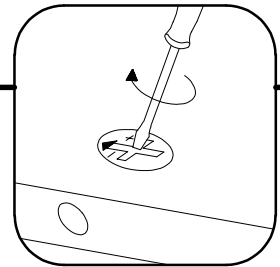
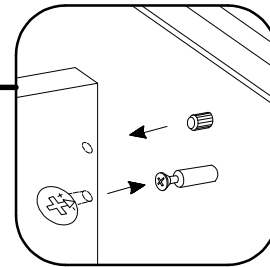
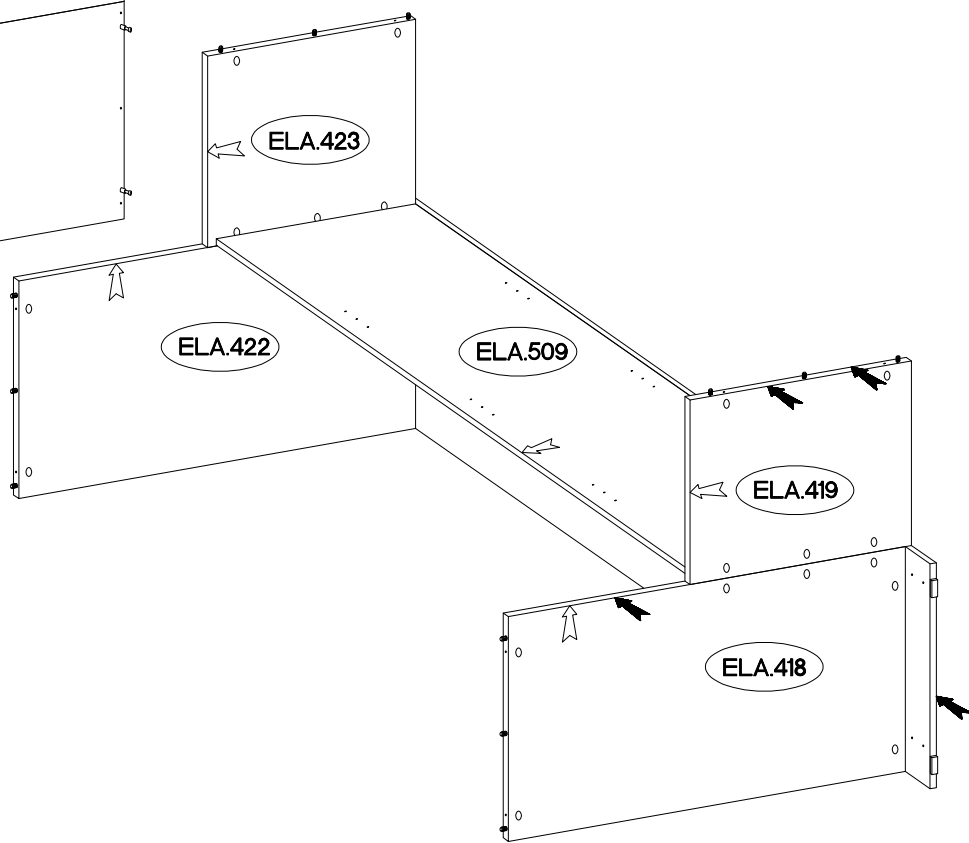
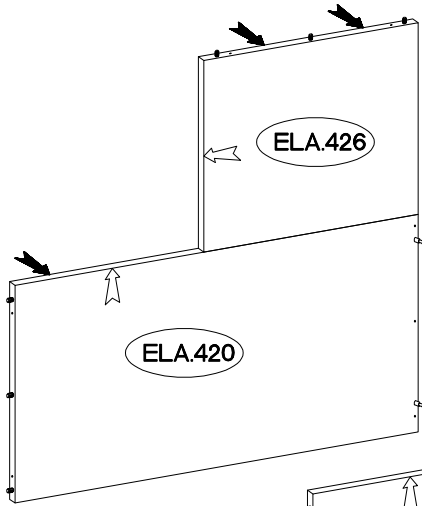

10

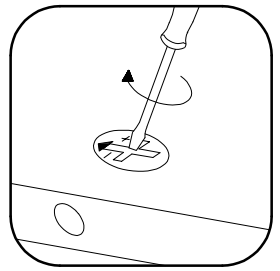
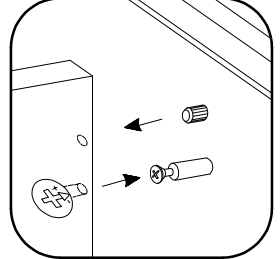
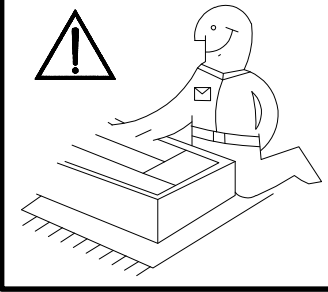
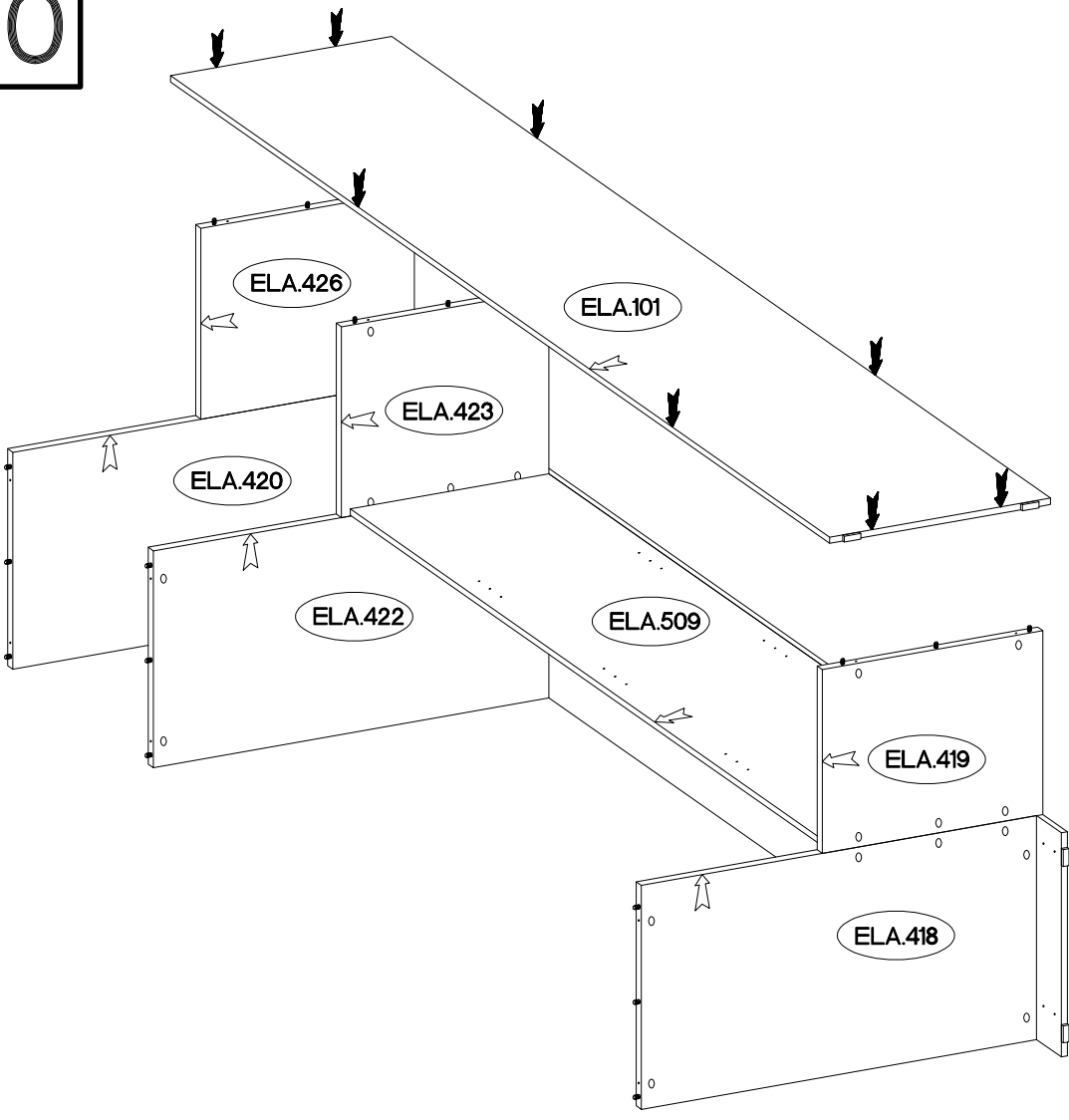

11

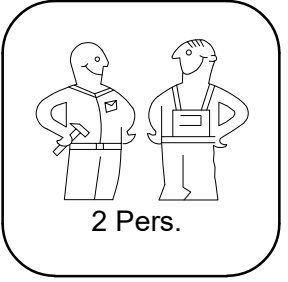
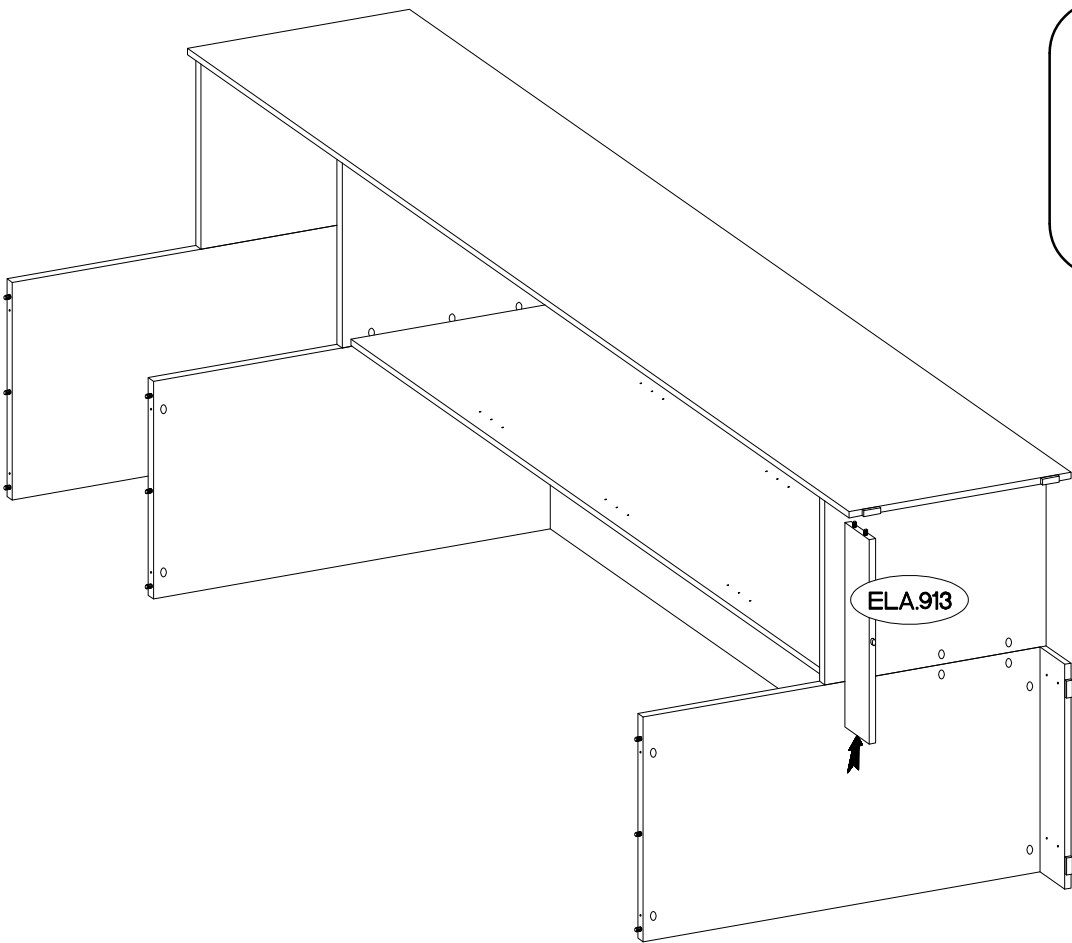

12

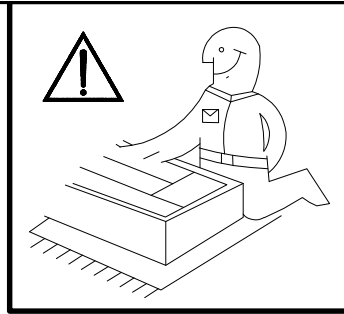
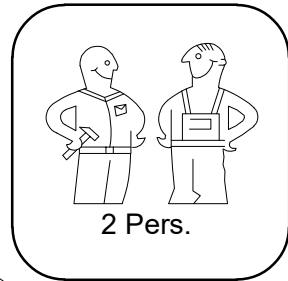
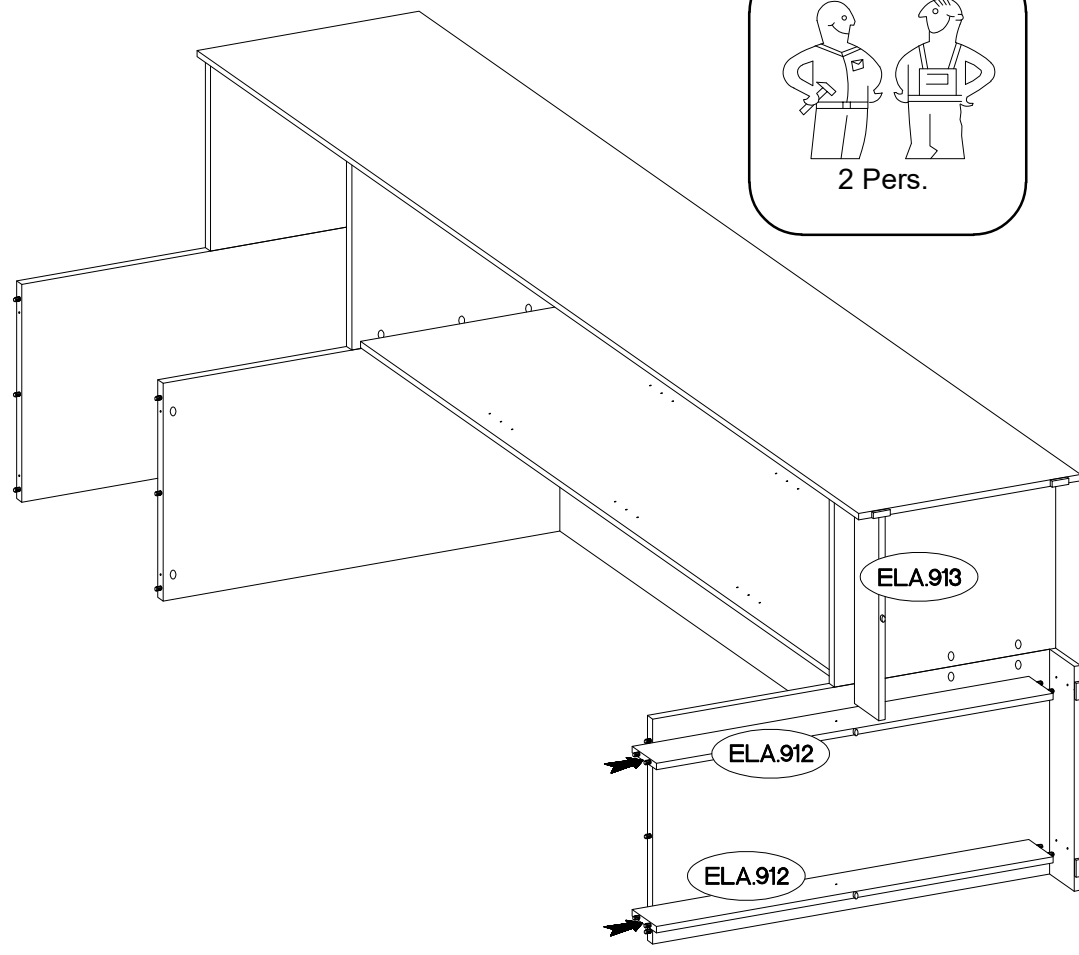

13

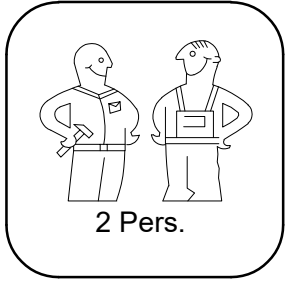
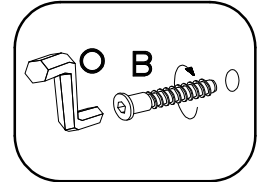
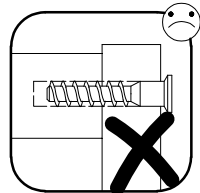
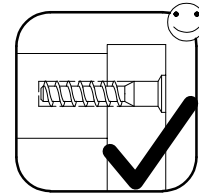
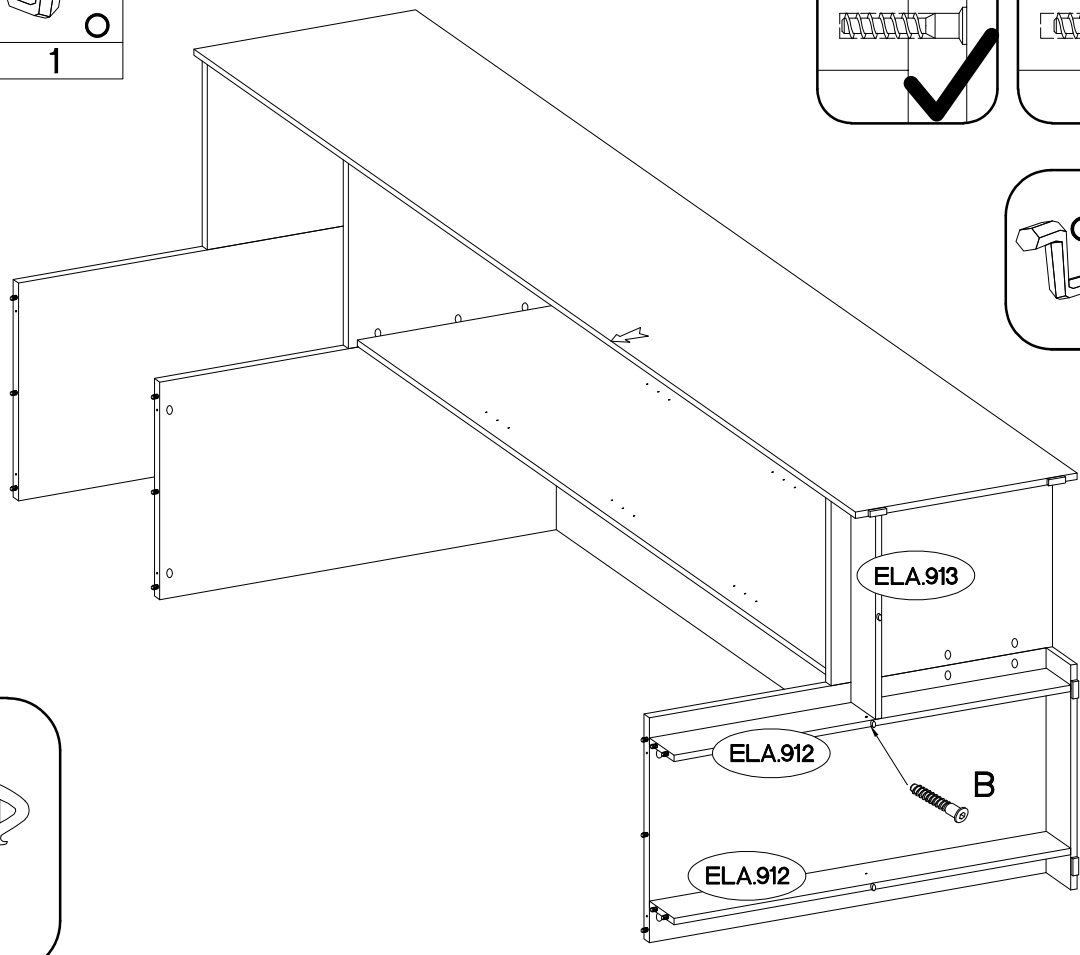
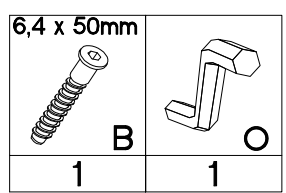

14

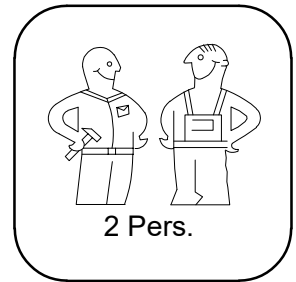
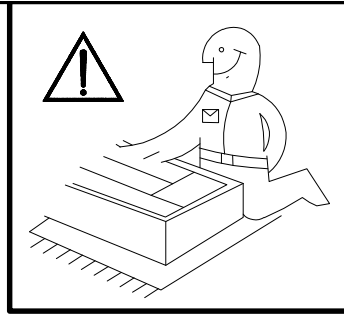
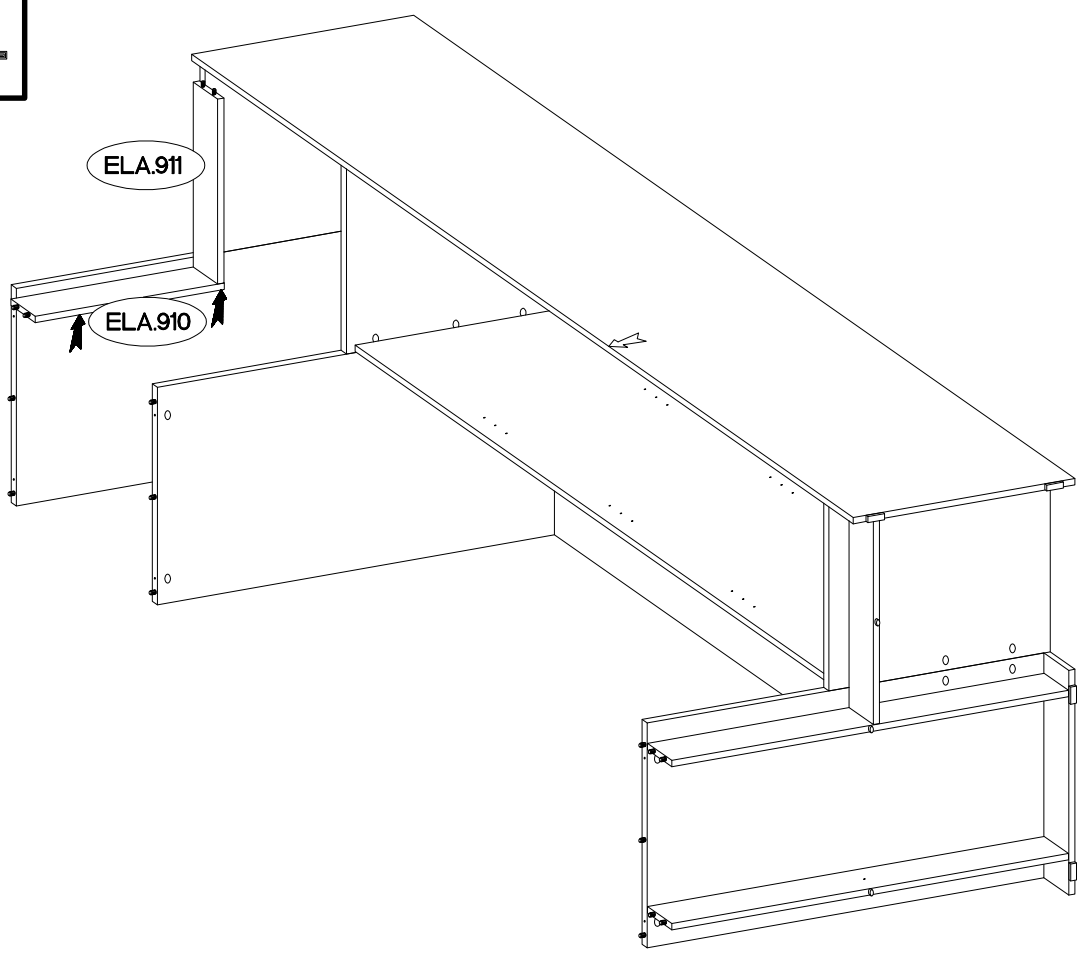

15

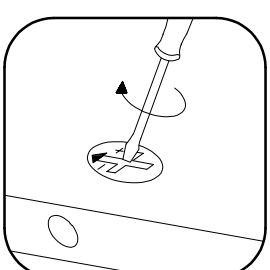
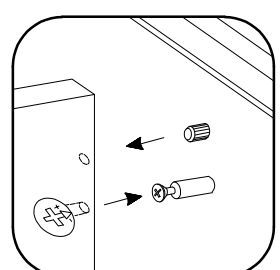
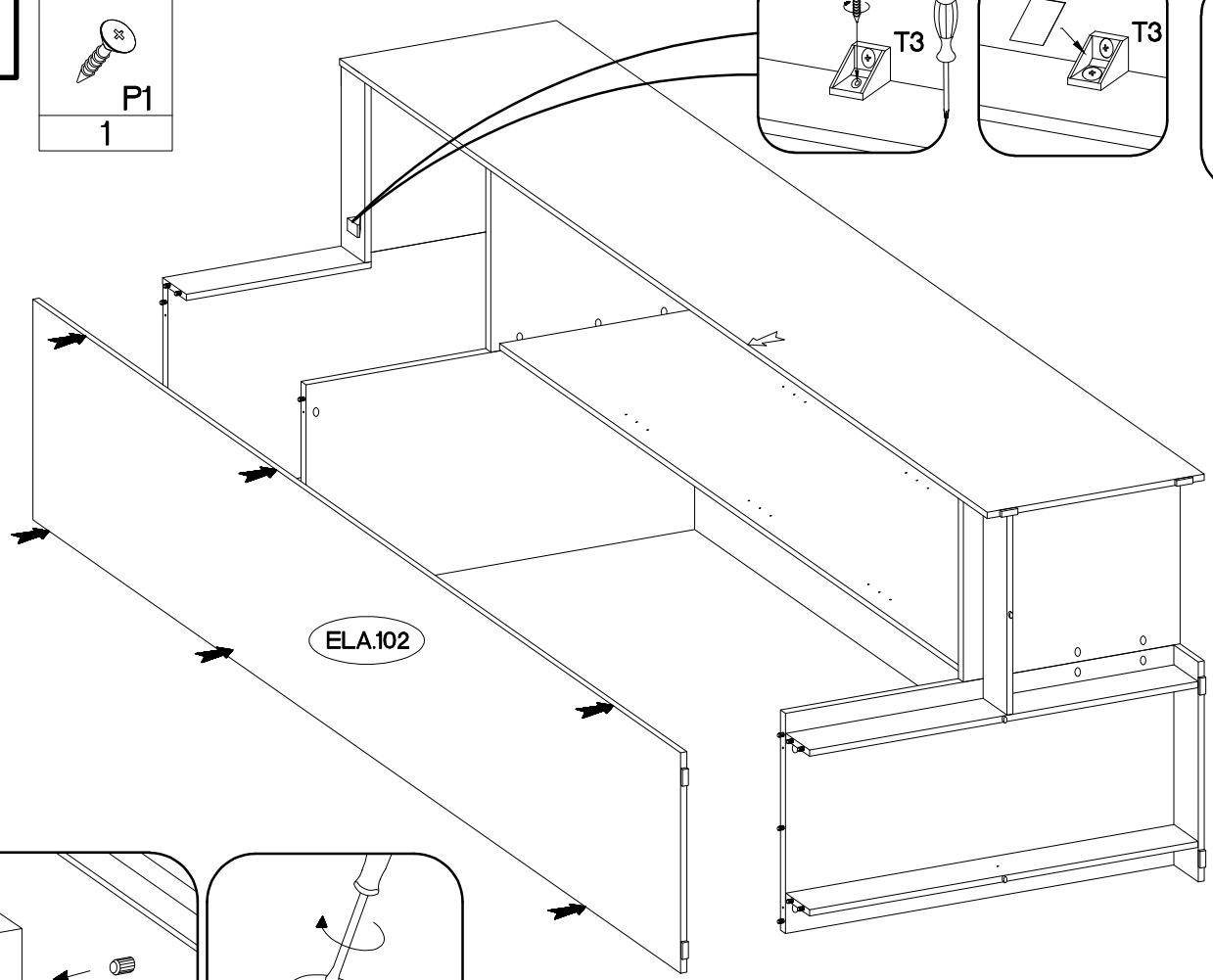
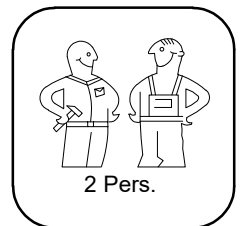
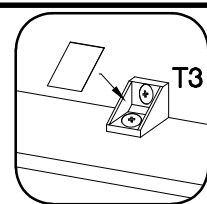
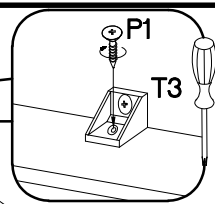
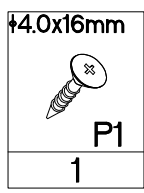



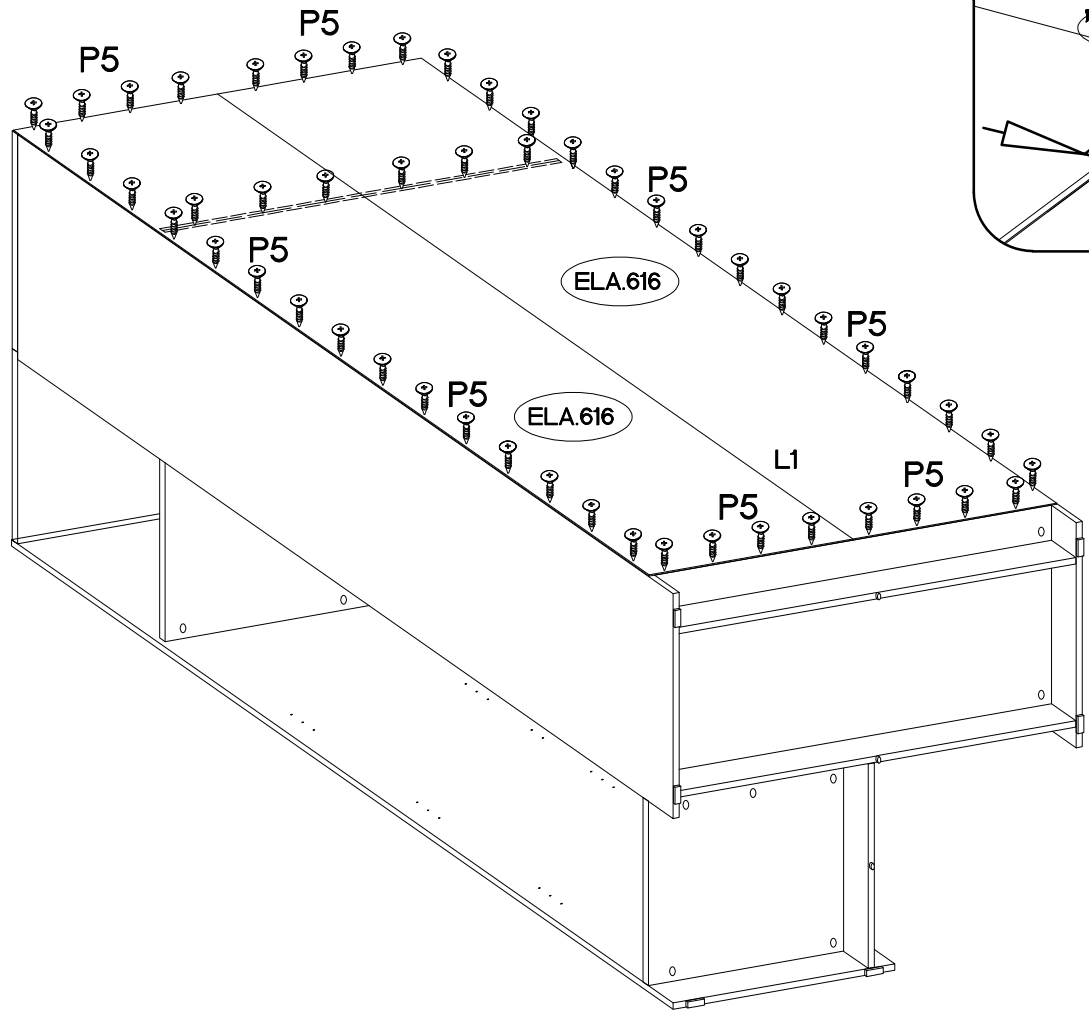
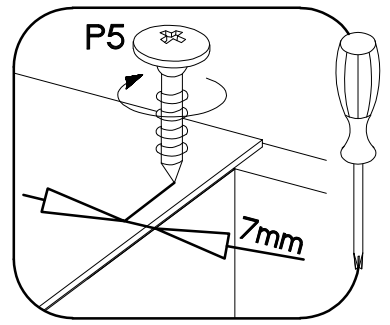
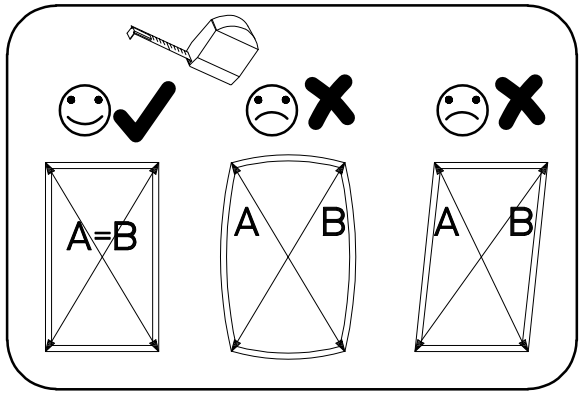
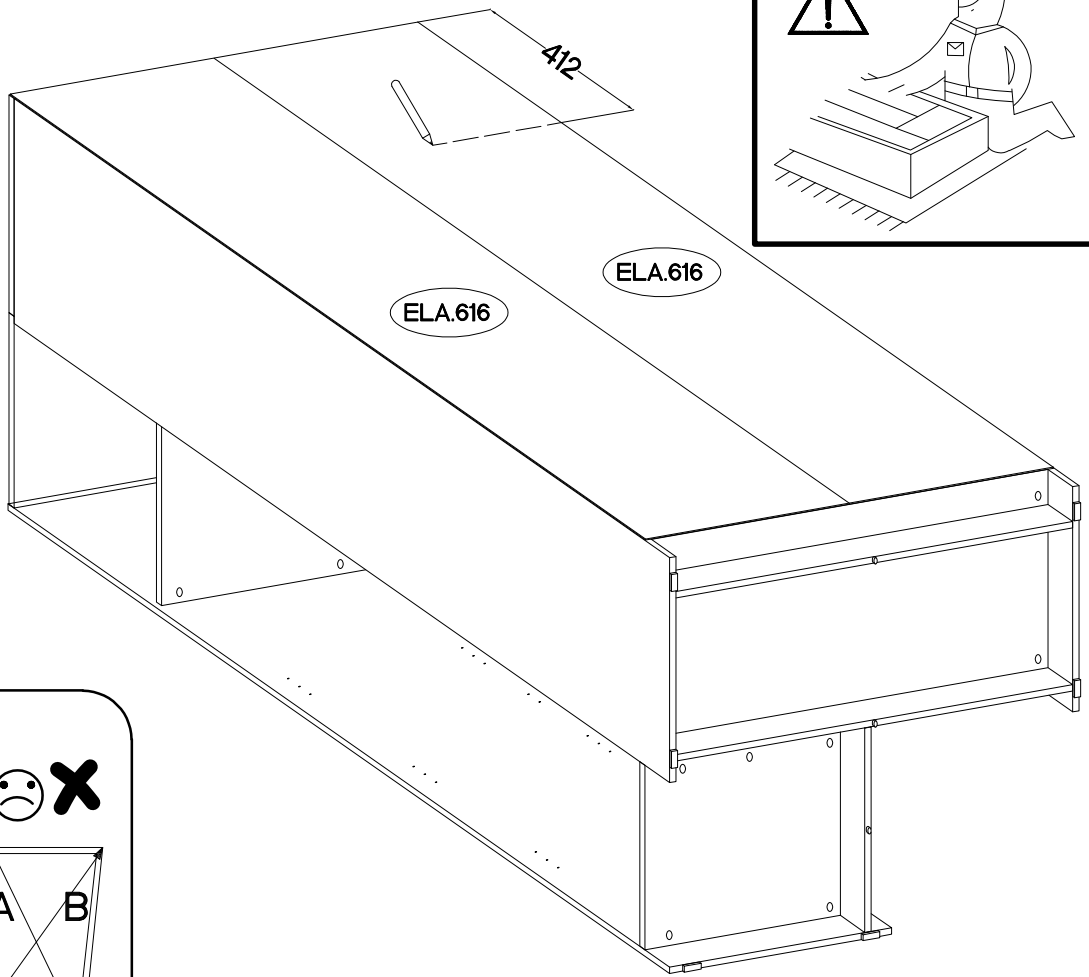
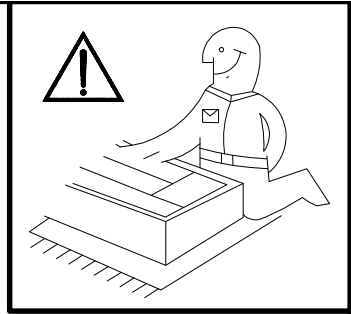

±3.5x13mm
P5
55-60

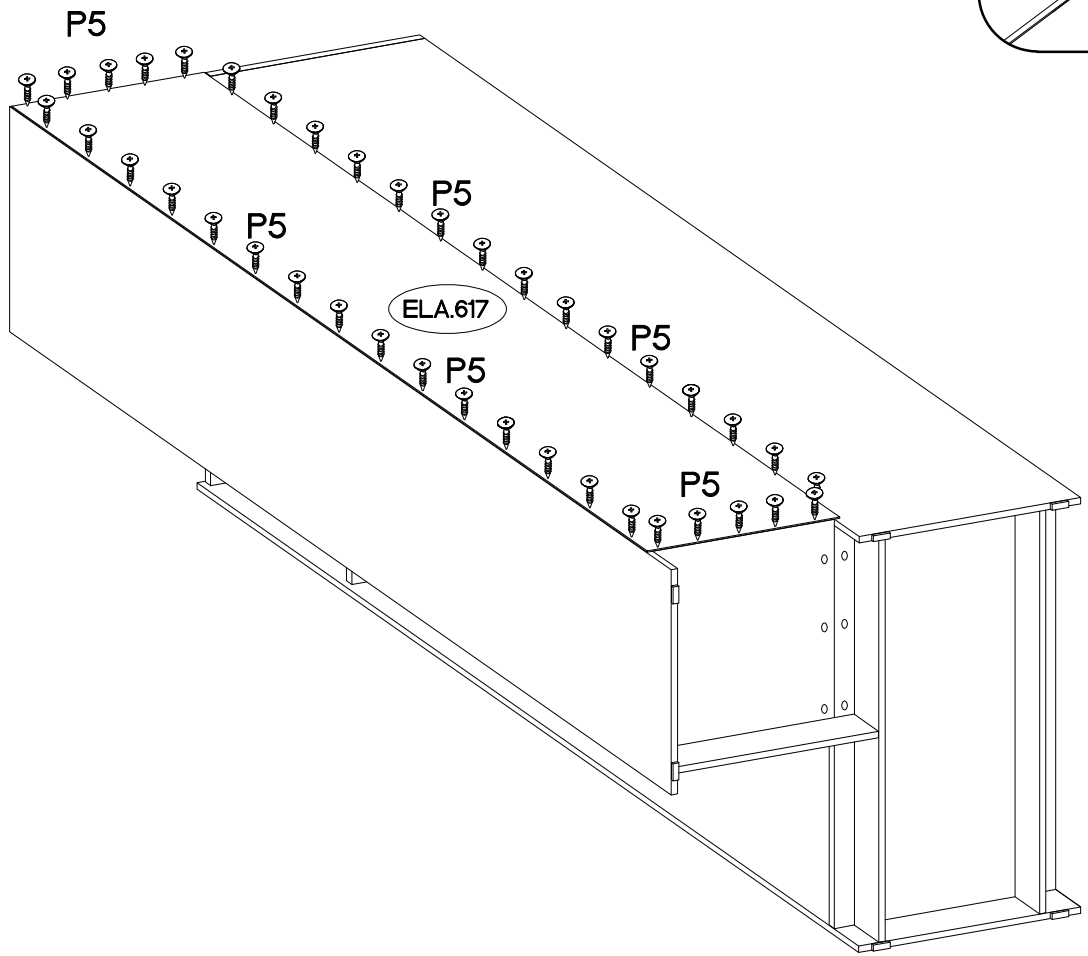
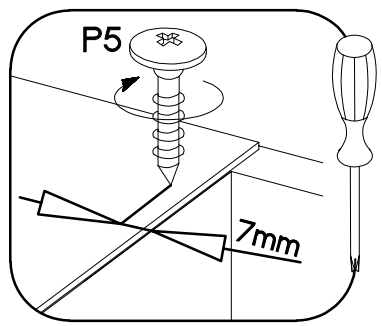
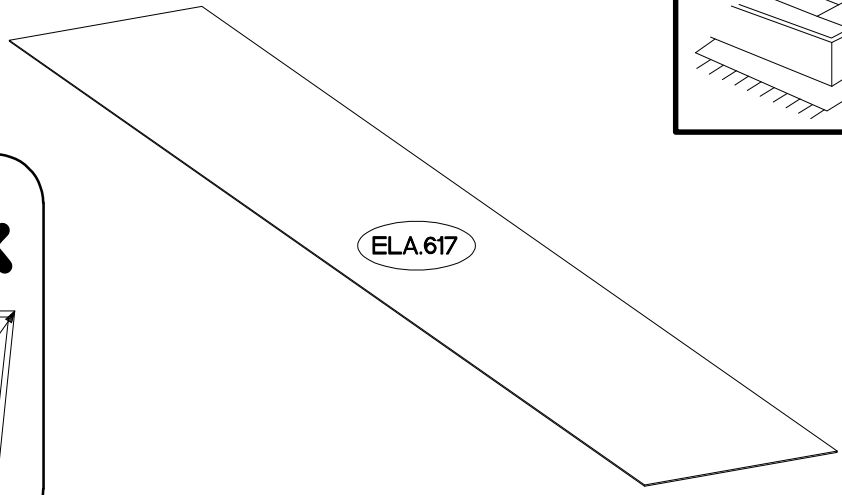
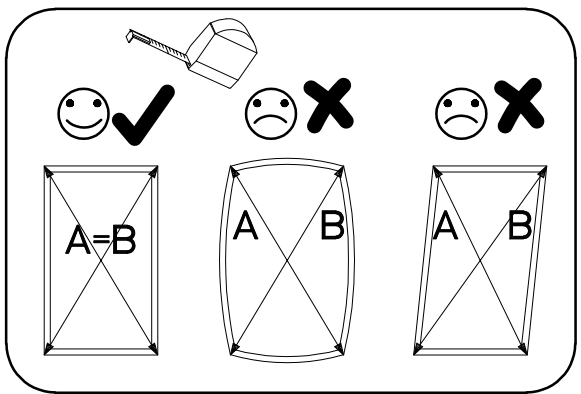
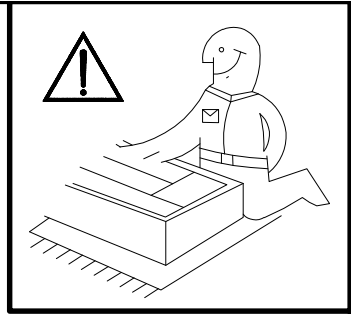

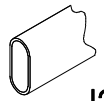



3.5x13mm
P5
45-50

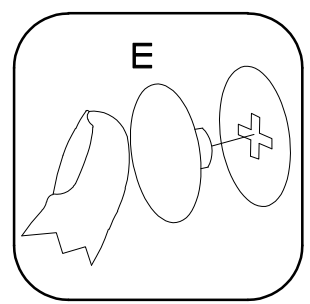
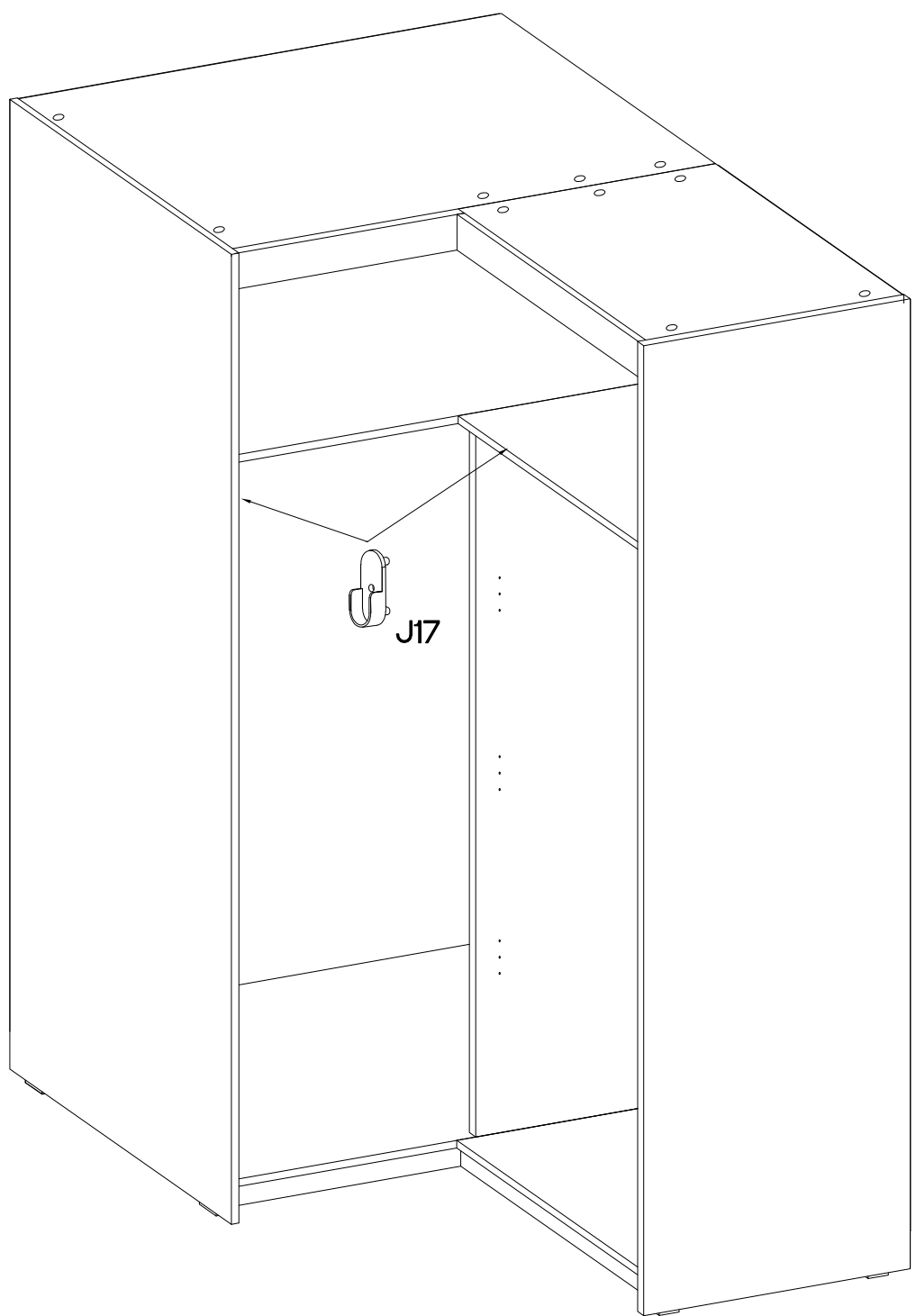
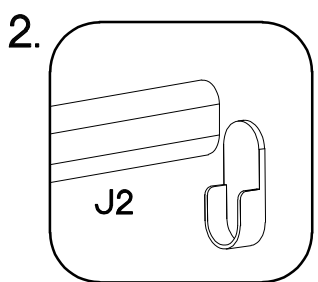
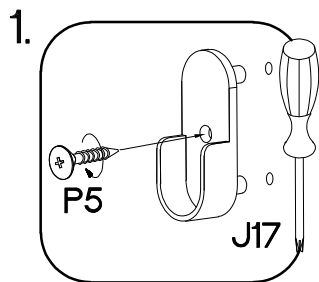

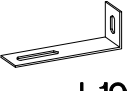
L=940mm  J2 1	 J17 2	φ3.5x13mm  P5 2	 E 15
--	--	--	---



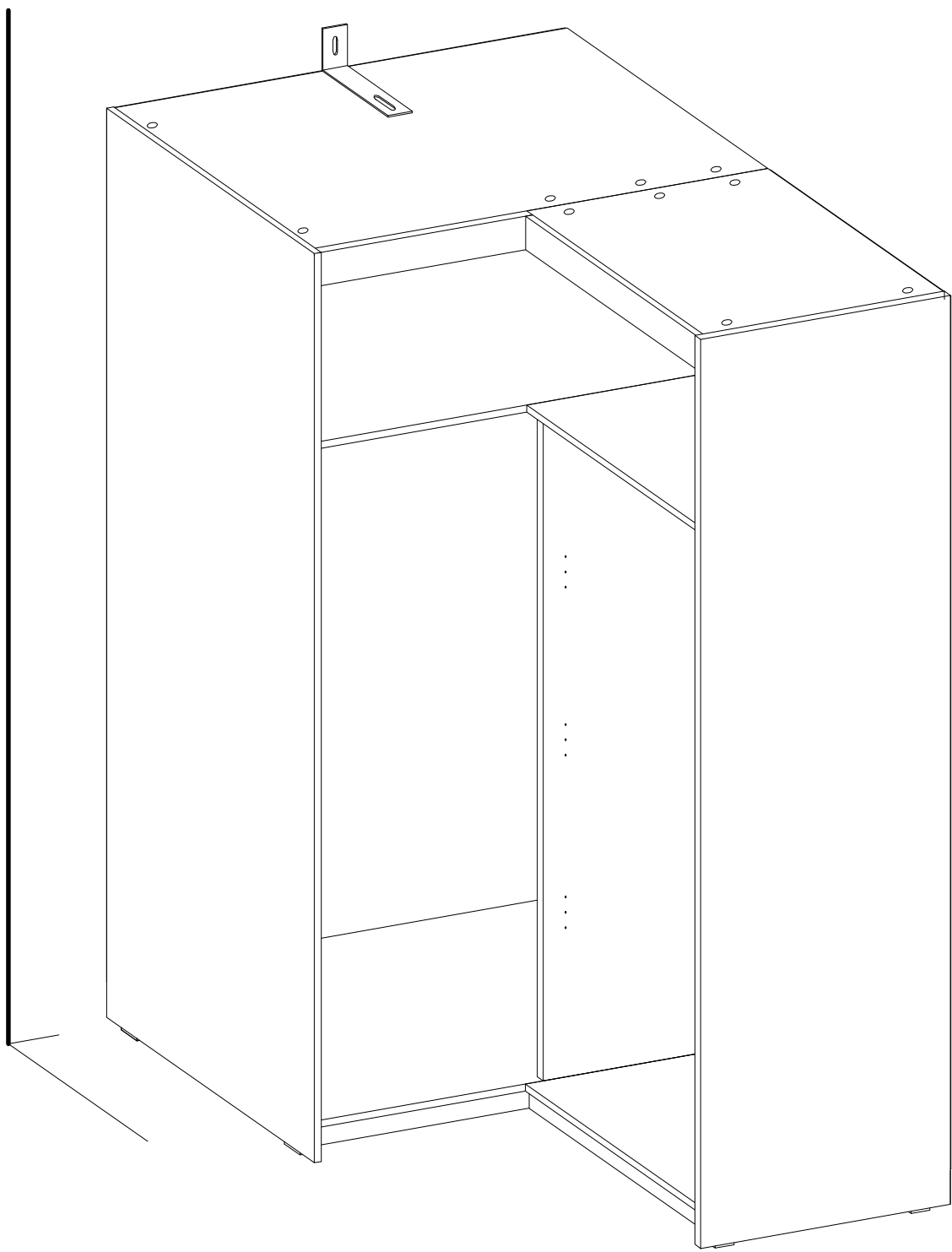
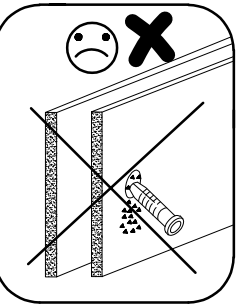
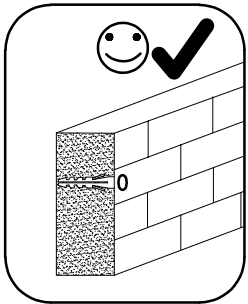
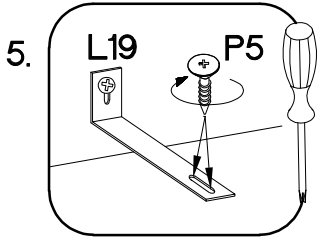
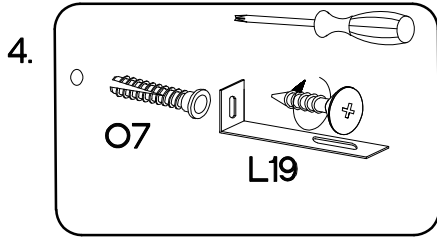
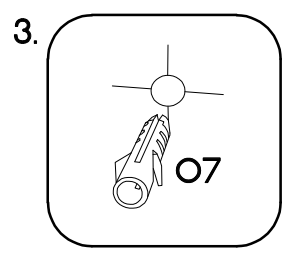
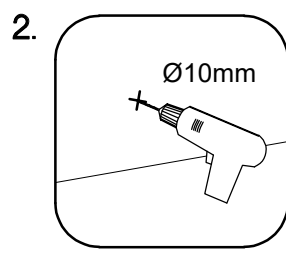
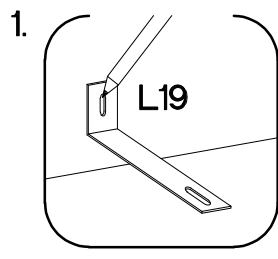

	†3.5x13mm	†5.0x60mm	†10x50mm
			
L19	P5	P12	O7
1	2	1	1

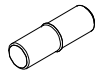

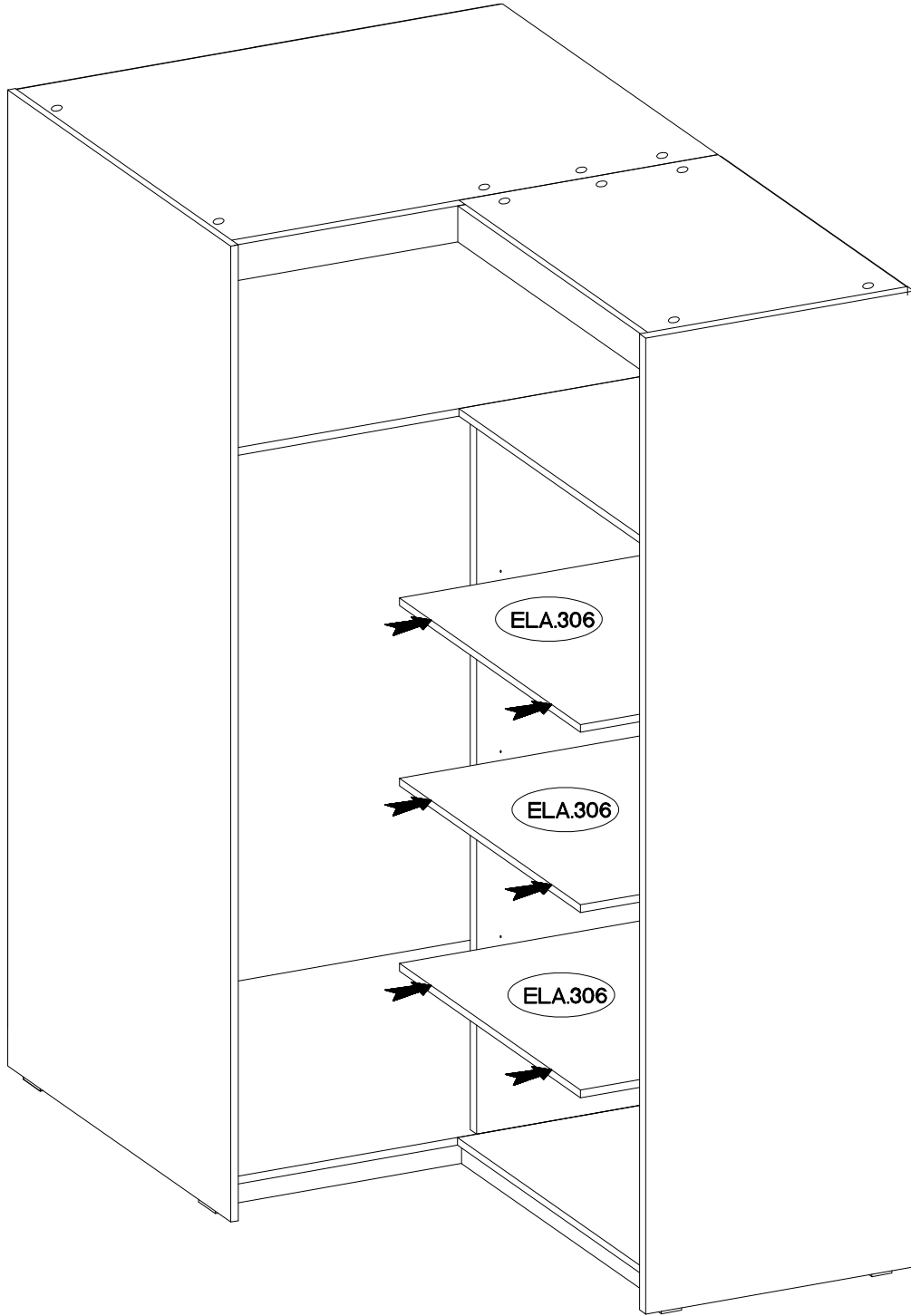
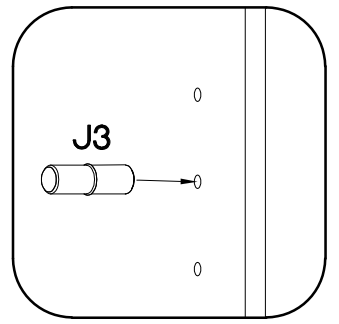

+5/16mm

J3
12

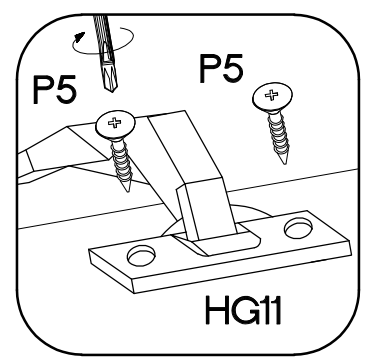
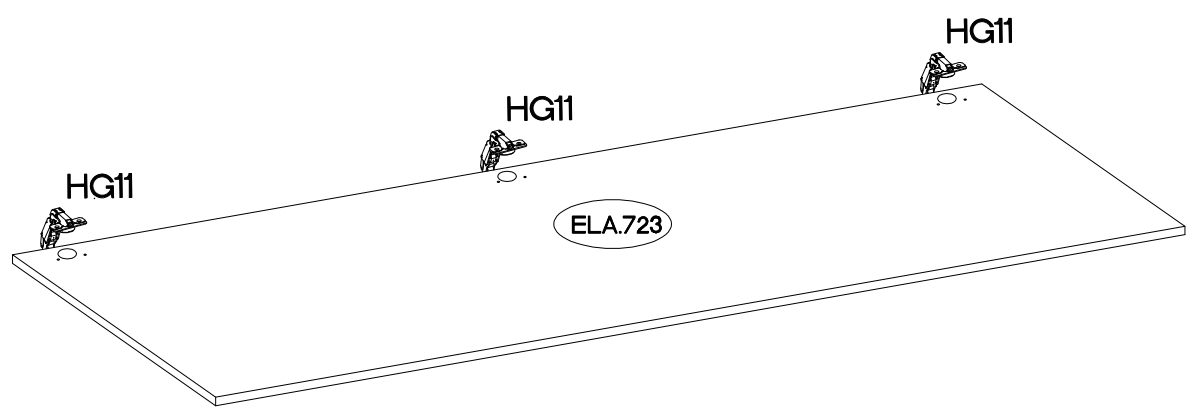
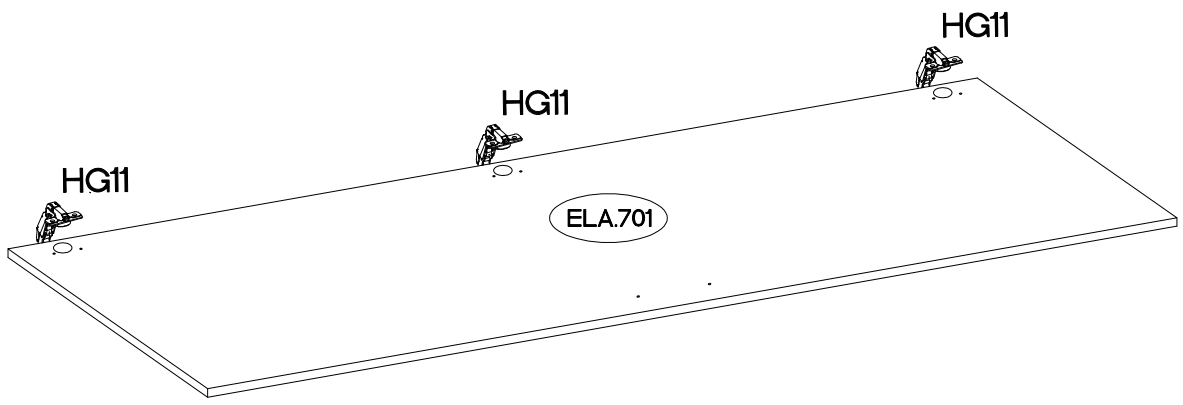
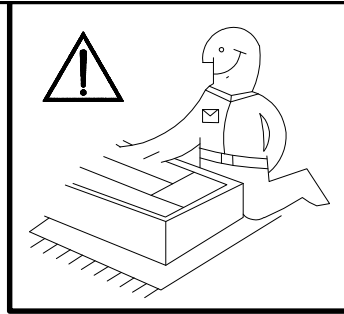

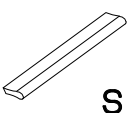
 +35/175	 +3.5x13mm
HG11	P5
6	12

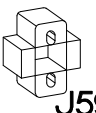

L=128mm	±4.0x30mm	±6,3x30mm	H=16mm
			
S	R2	M11	J59
1	2	12	6

