

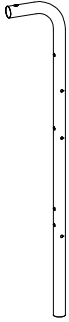

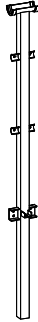

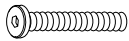





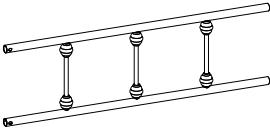

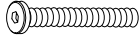
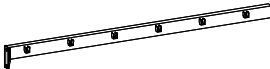

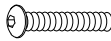

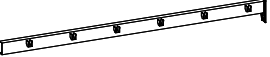
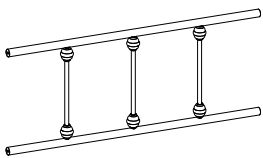

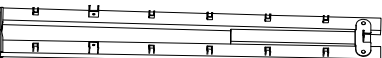
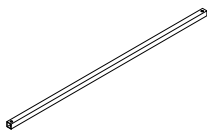

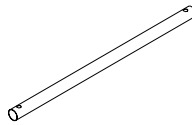
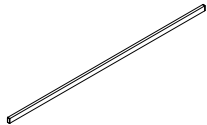









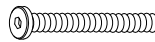
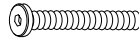

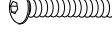





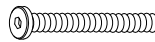
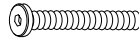

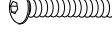





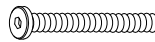
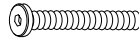

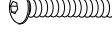
<p>① x2</p> 	<p>⑦ x1</p> 	<p>A</p>  <p>M8x50</p> <p>8</p>	<p>B</p>  <p>M6x60</p> <p>2</p>																														
<p>② x2</p> 	<p>⑧ x2</p> 	<p>F</p>  <p>1</p>	<p>C</p>  <p>M6x55</p> <p>12</p>																														
<p>③ x1</p> 	<p>⑨ x2</p> 	<p>G</p>  <p>M6x40</p> <p>6</p>	<p>D</p>  <p>M6x30</p> <p>2</p>																														
<p>④ x1</p> 	<p>⑩ x2</p> 	<p>H</p>  <p>3</p>	<p>E</p>  <p>M6x12</p> <p>8</p>																														
<p>⑤ x1</p> 	<p>⑪ x1</p> 	<p>I</p>  <p>2</p>	<p>J</p>  <p>22</p>																														
<p>⑥ x2</p> 	<p>⑫ x12</p> 	<p>J</p>  <p>22</p>	<p>K</p>  <p>M8</p> <p>4</p>																														
		<p>L</p>  <p>12</p>	<p>M</p>  <p>2</p>																														
		<p>M</p>  <p>2</p>	<p>N</p>  <p>1</p>																														
		<p>N</p>  <p>1</p>	<p>O</p>  <p>1</p>																														
		<p>SPARE</p> <table border="1"> <tbody> <tr> <td>A</td> <td></td> <td>1</td> </tr> <tr> <td>B</td> <td></td> <td>1</td> </tr> <tr> <td>C</td> <td></td> <td>1</td> </tr> <tr> <td>D</td> <td></td> <td>1</td> </tr> <tr> <td>E</td> <td></td> <td>1</td> </tr> <tr> <td>G</td> <td></td> <td>1</td> </tr> <tr> <td>J</td> <td></td> <td>1</td> </tr> <tr> <td>K</td> <td></td> <td>1</td> </tr> <tr> <td>L</td> <td></td> <td>1</td> </tr> <tr> <td>M</td> <td></td> <td></td> </tr> </tbody> </table>		A		1	B		1	C		1	D		1	E		1	G		1	J		1	K		1	L		1	M		
A		1																															
B		1																															
C		1																															
D		1																															
E		1																															
G		1																															
J		1																															
K		1																															
L		1																															
M																																	
		<p>3/11</p>																															



Step 1

C	 M6x55	4
J		4
L		4

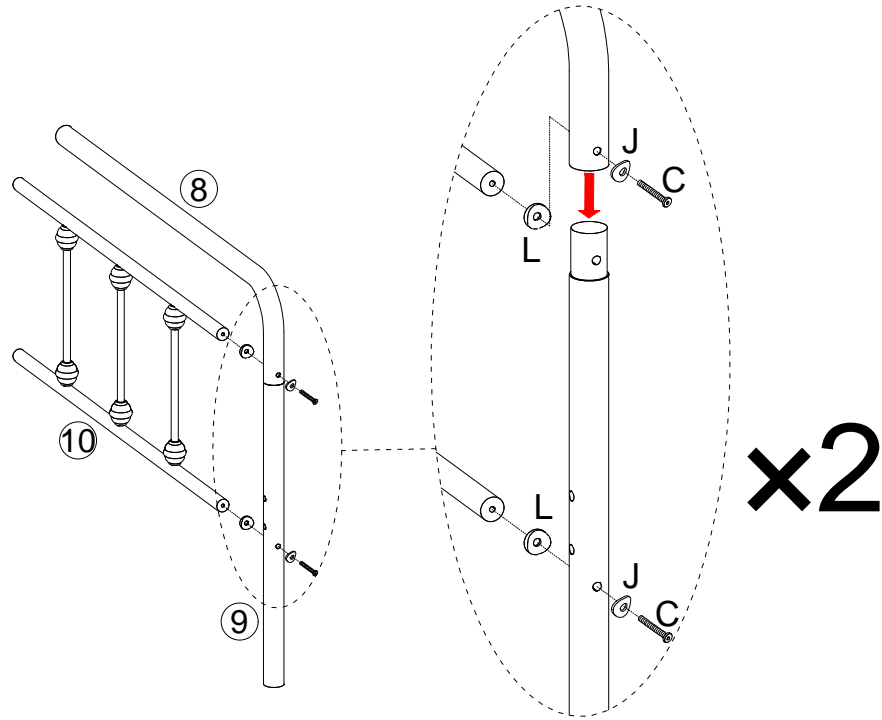

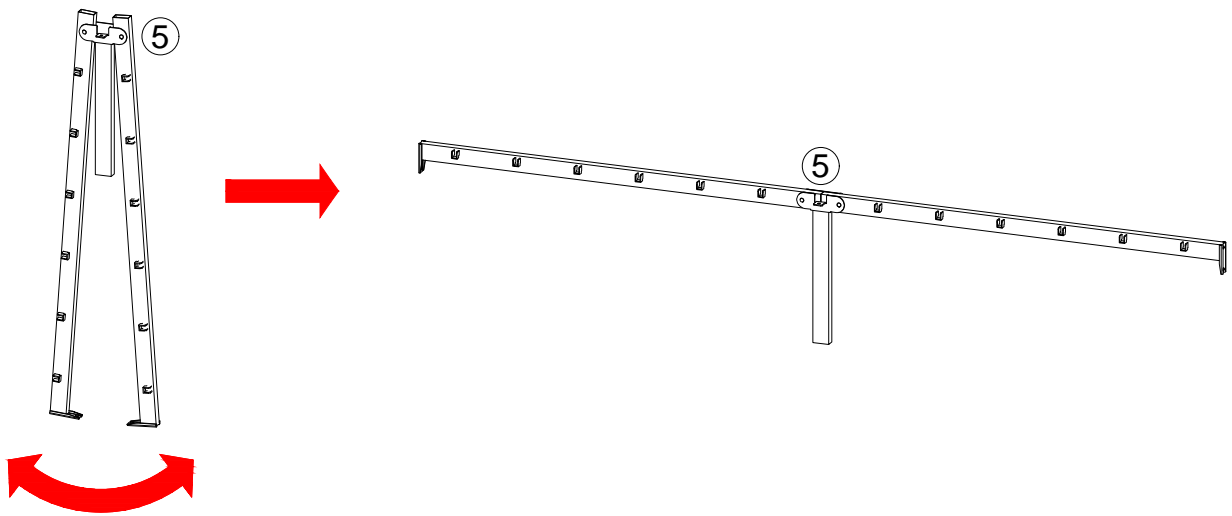
Step 2

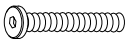

A		M8x50	4
J			4
K		M8	2

Step 3

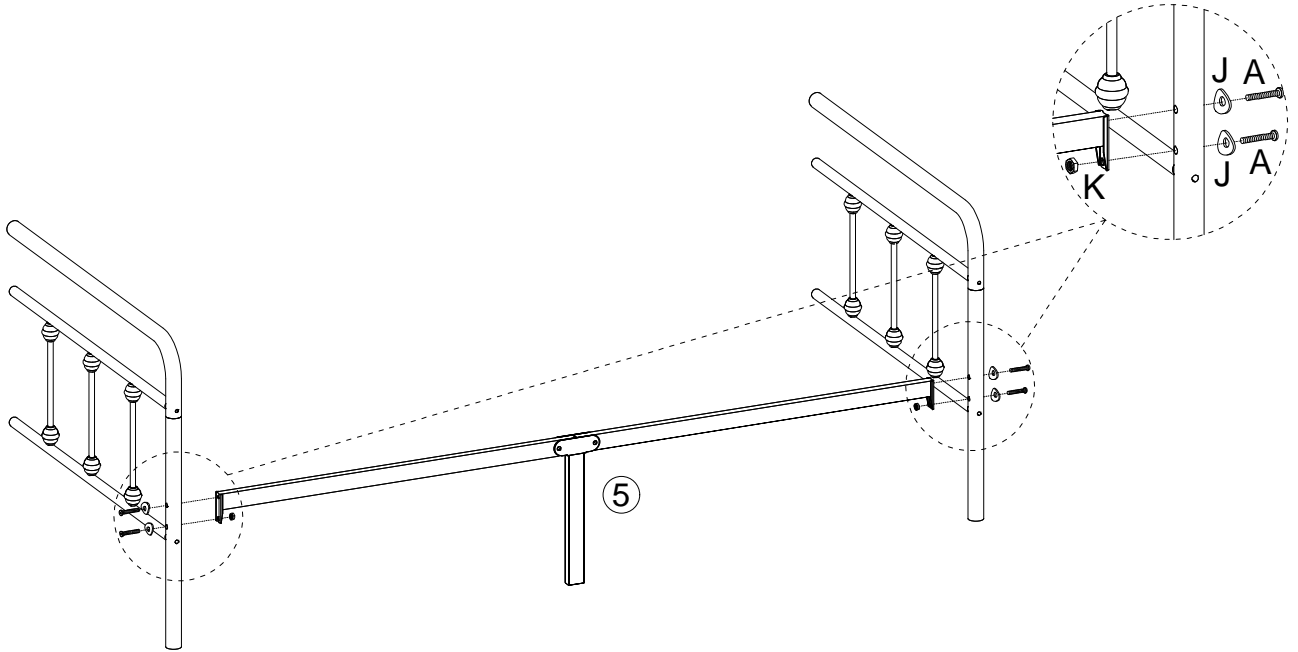



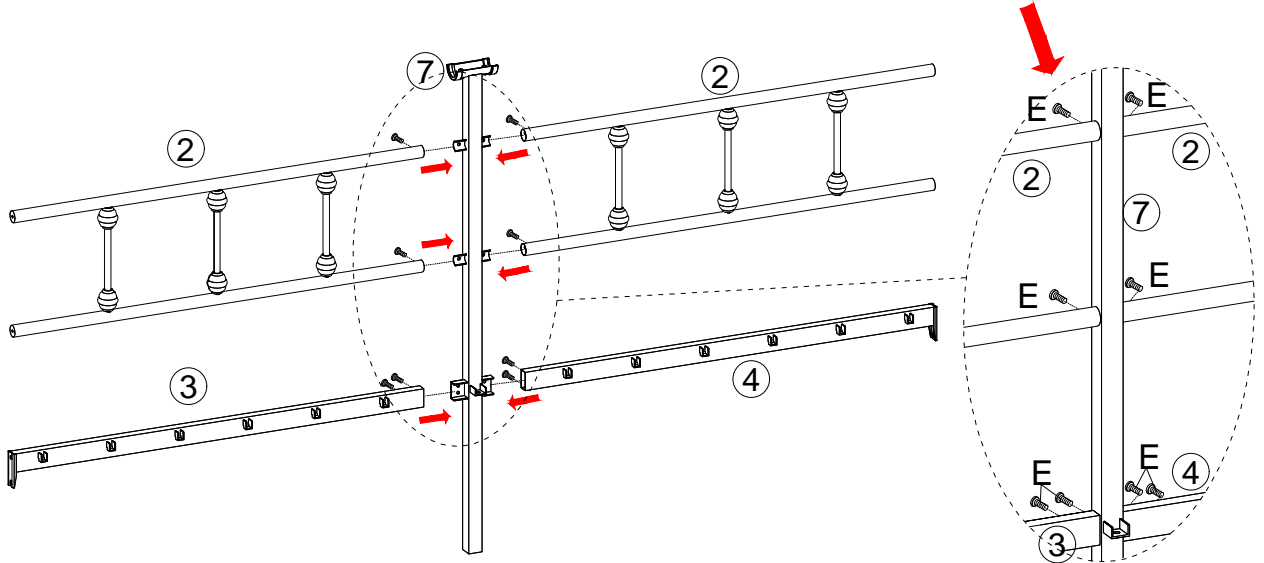

E		M6x12	8
---	---	-------	---

Step 4

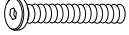
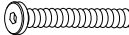

Please put the metal strip on part 7 into the round tube of part 2



A		M8x50	4
C		M6x55	4
J			8
L			4
K		M8	2

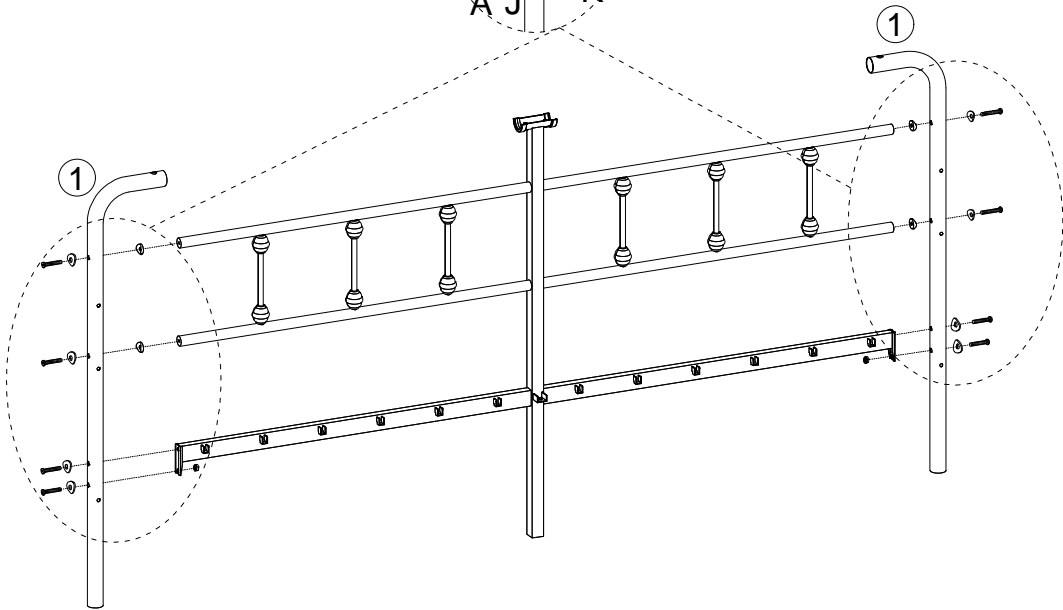
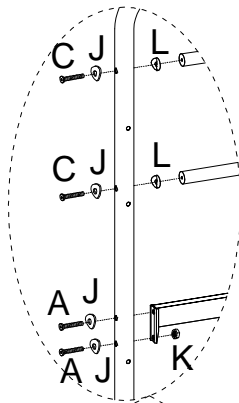

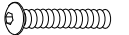

Step 5

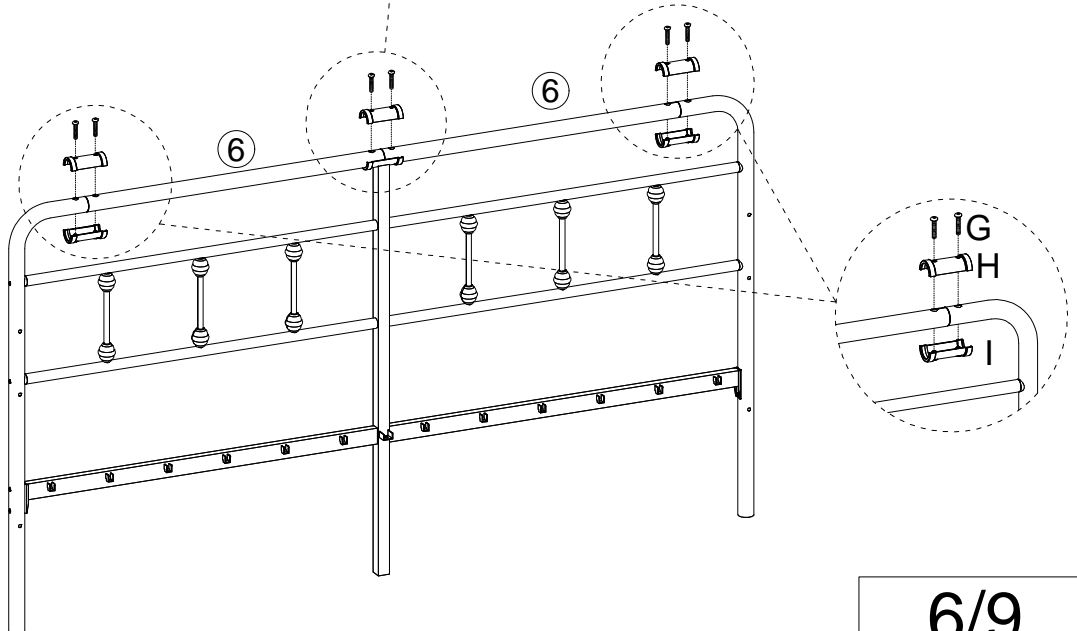
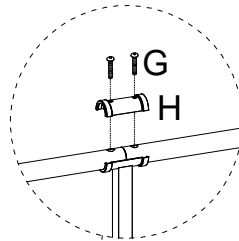

G		M6x40	6
H			3
I			2

Step 6



B		M6x60	2
C		M6x55	4
J			6
L			4
M			2

Step 7

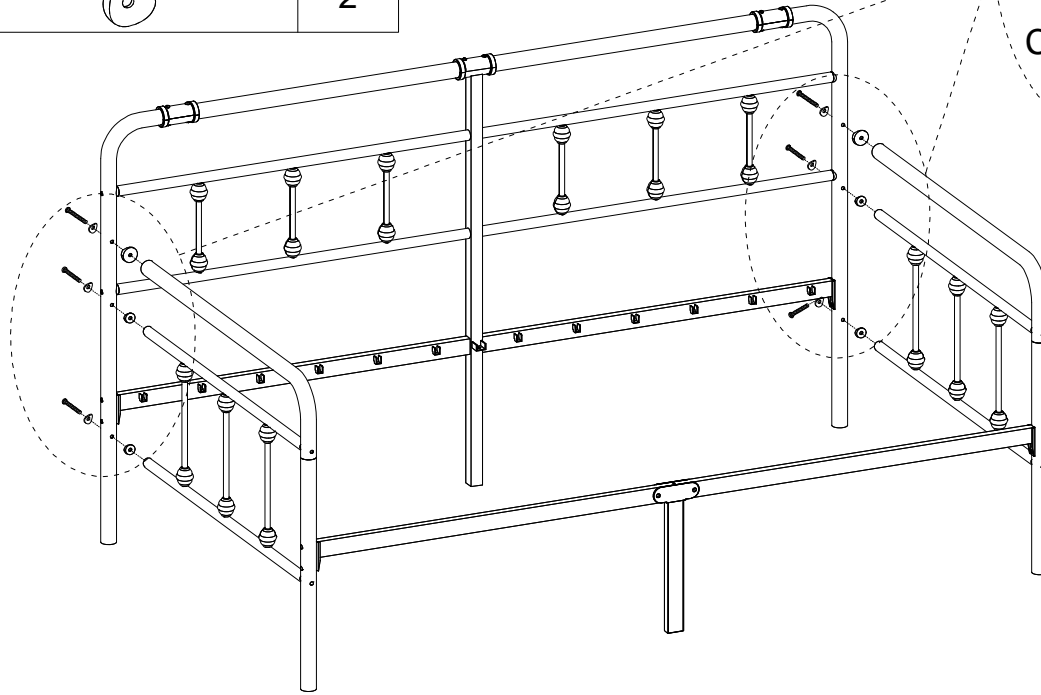
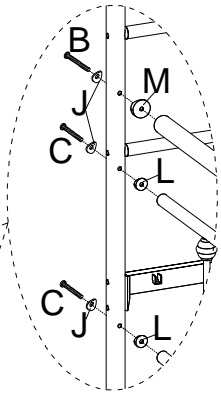

D		M6x30	2
---	---	-------	---

Step 8

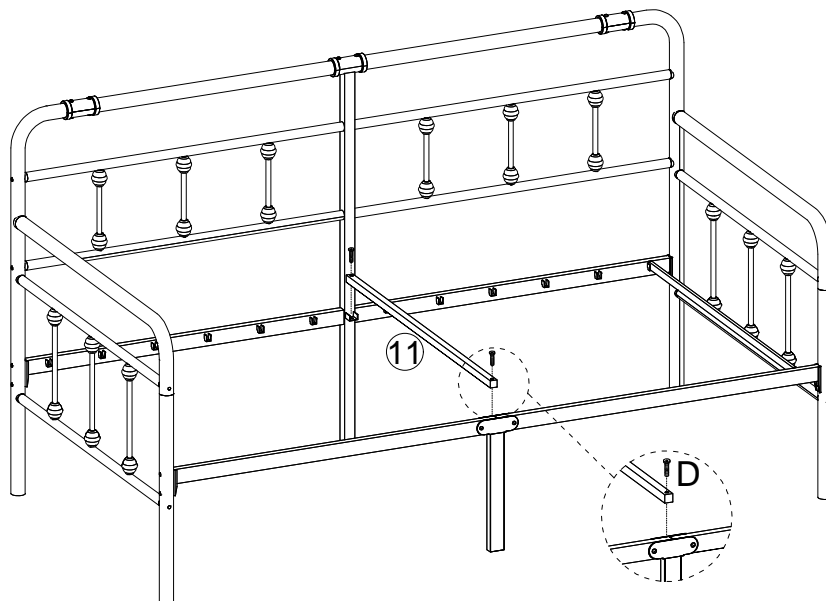

Step 9

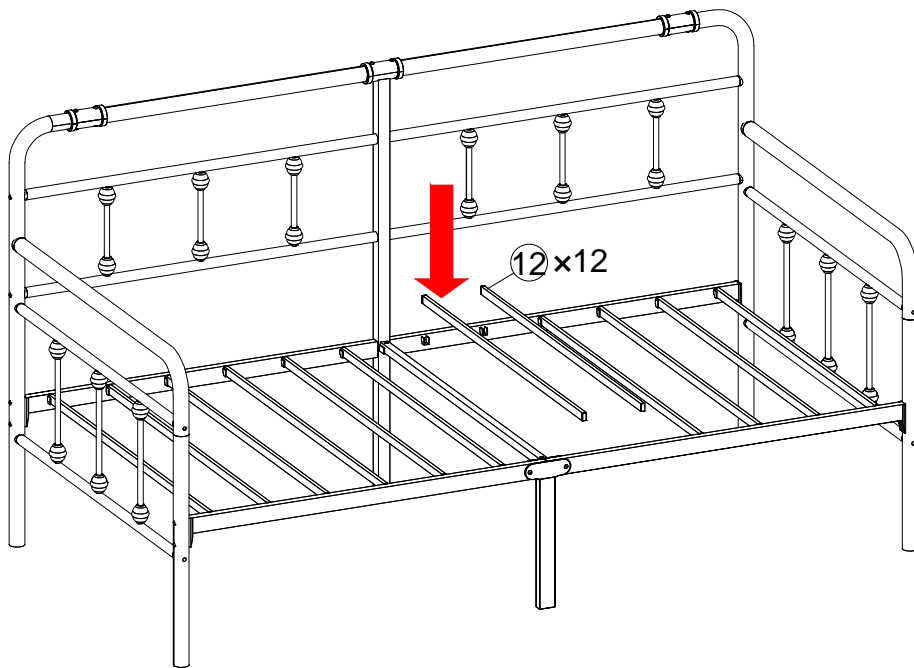

Step 10

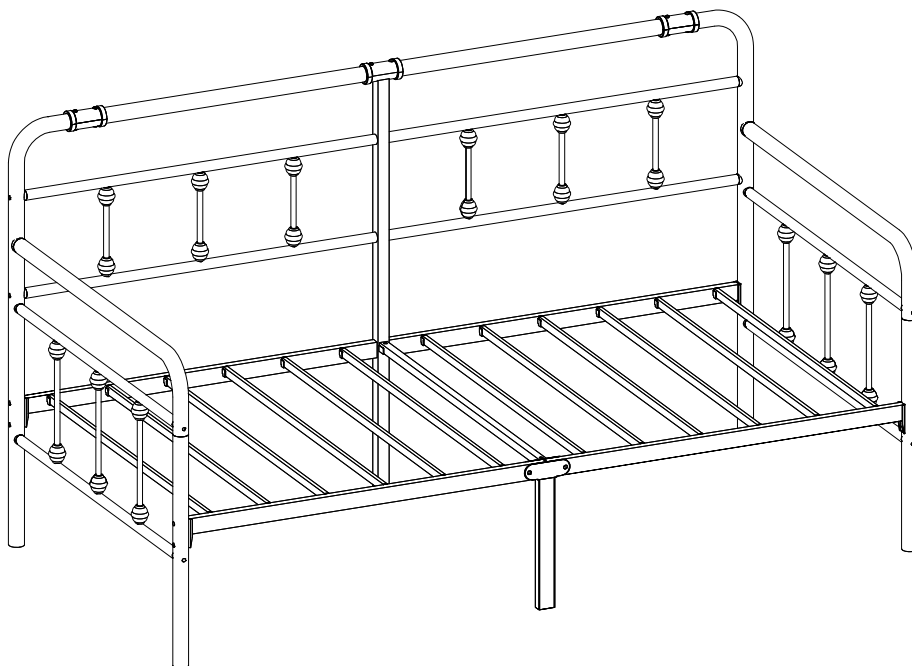

ASSEMBLY INSTRUCTION

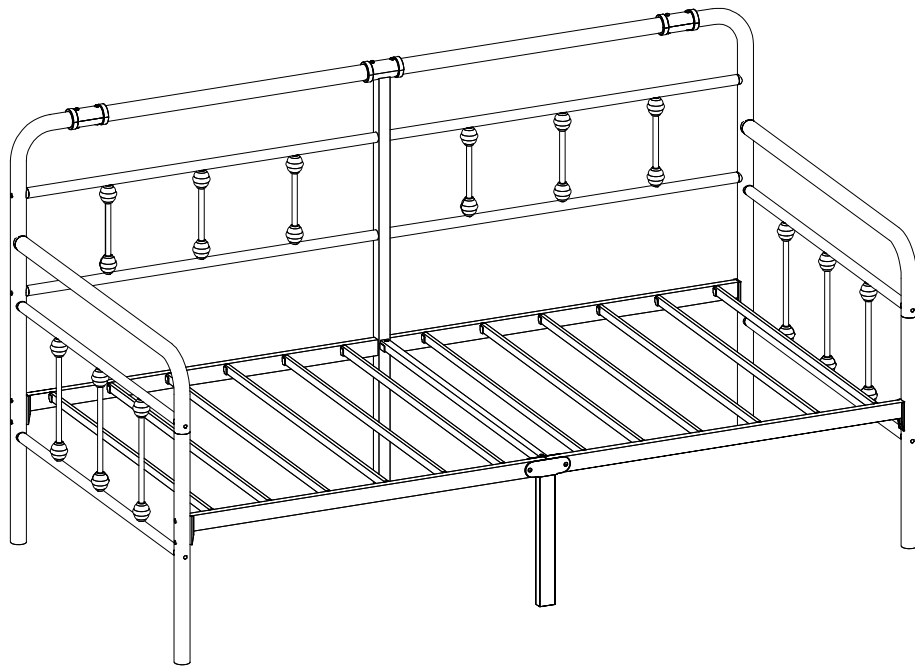

Please fully tight all the screws then finish assembly