

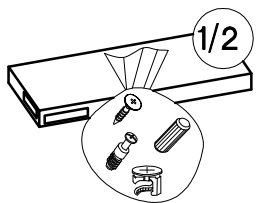

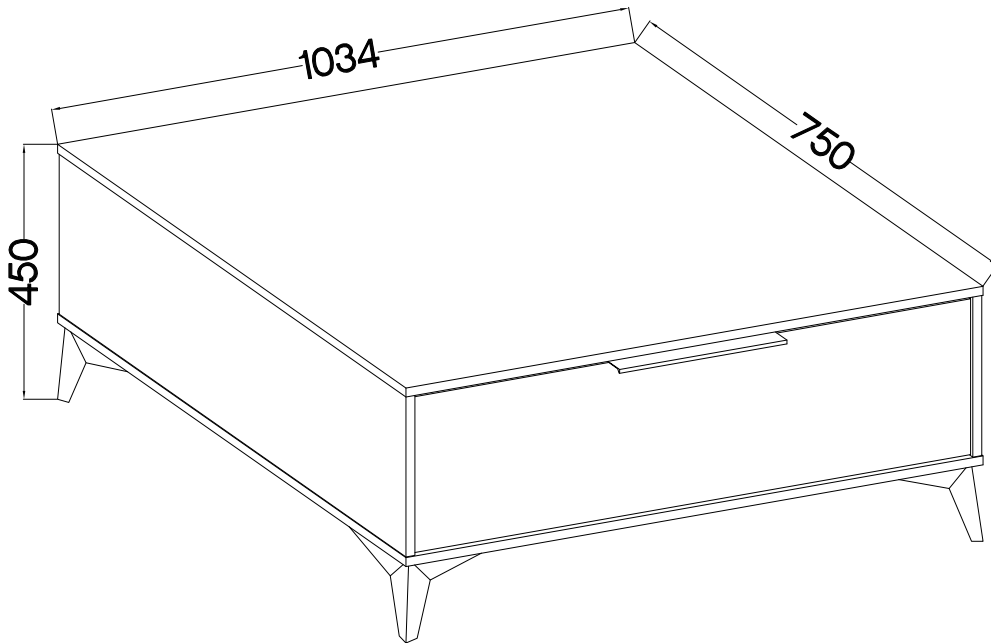

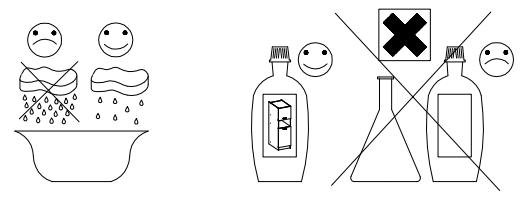











TYP 201



 $\pm 8 \times 30 \text{mm}$ <b>A</b> 42	 $\pm 6 \times 42 \text{mm}$ <b>B2</b> 4	 $\pm 15 / 12 \text{mm}$ <b>C</b> 18	 $\pm 12 / 10 \text{mm}$ <b>C5</b> 4	 $L = 20 \text{mm}$ <b>D2</b> 22				
 $27 / 310 \text{mm}$ <b>I4</b> 2	 $\pm 20 / 8 \text{mm}$ <b>J14</b> 4	 <b>L</b> 4	 $\pm 6,3 \times 13 \text{mm}$ <b>M2</b> 4	 $\pm 6,3 \times 20 \text{mm}$ <b>M3</b> 4	 $\pm 3,5 \times 13 \text{mm}$ <b>P5</b> 2	 $\pm 4,0 \times 16 \text{mm}$ <b>R11</b> 16	 $L = 256 \text{mm}$ <b>S</b> 1	 $M4 \times 9 \text{mm}$ <b>U1</b> 4

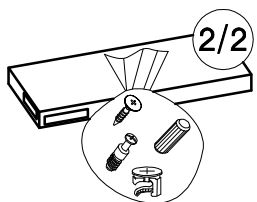

 $L = \pm 30 \text{mm}$ <b>F33</b> 4
--

ISM-XIX-004

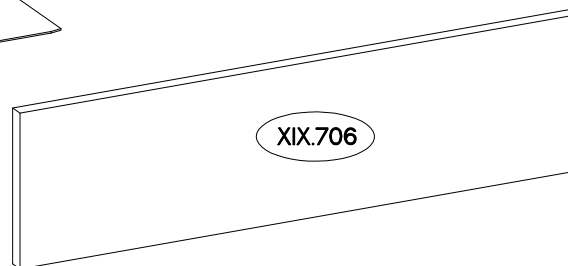
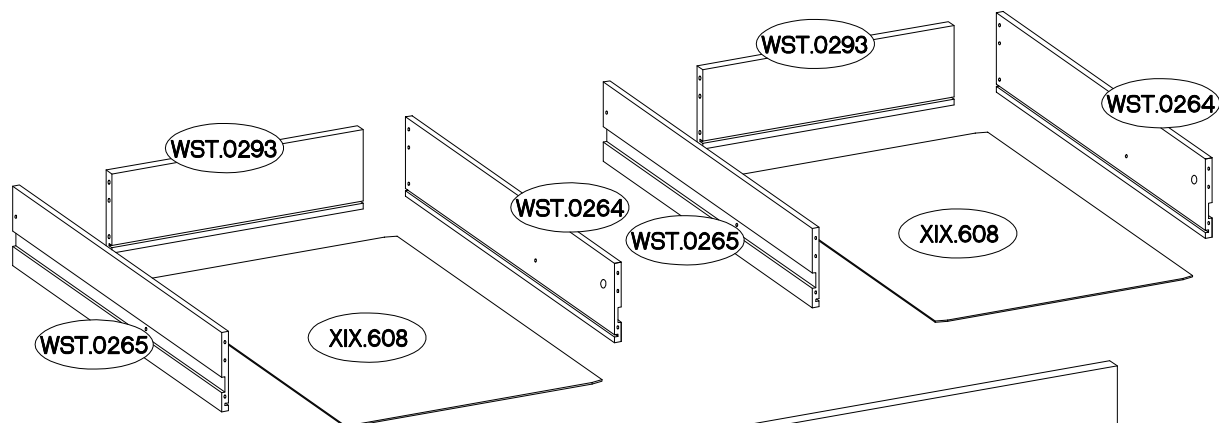
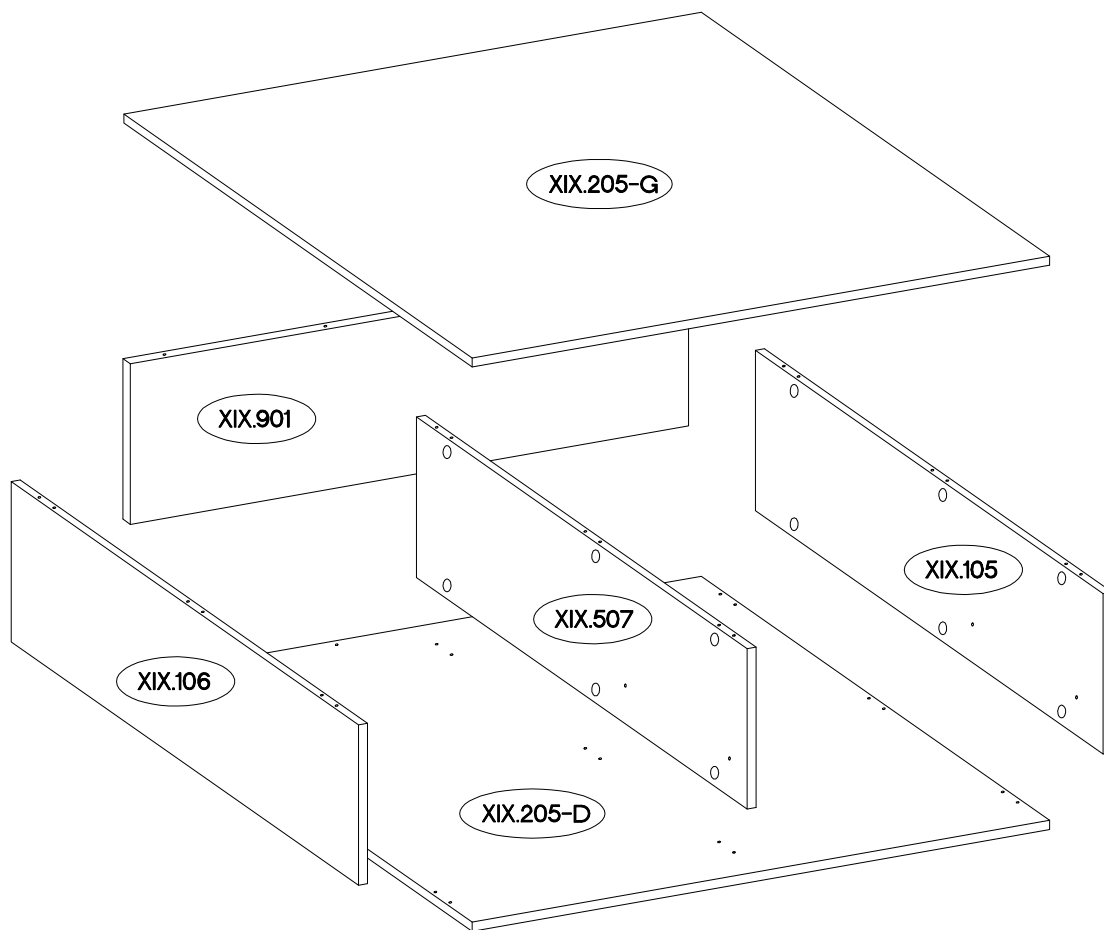

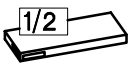
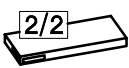
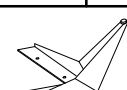
	Ersatzteil Nummer	Dimension
	XIX.105	283x748x16
	XIX.106	283x748x16
	XIX.505	283x712x16
	XIX.205 x2	1034x750x16
	XIX.901	283x1000x16
	XIX.607 x2	461x447x2,5
	WST.0264 x2	450x140x12
	WST.0265 x2	450x140x12
	WST.0293 x3	450x140x12
XIX.706	996x275x16	
		F33 x4





XIX.205-G



XIX.608

1

<p>±12/10mm</p>  <p>C5</p> <p>4</p>	<p>±8x30mm</p>  <p>A</p> <p>16</p>
---	--

x2

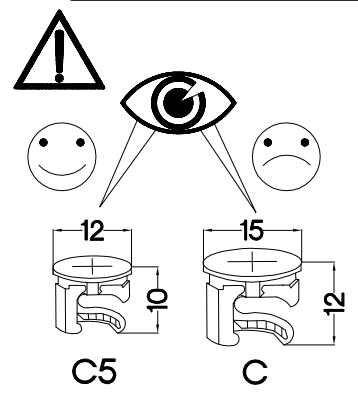
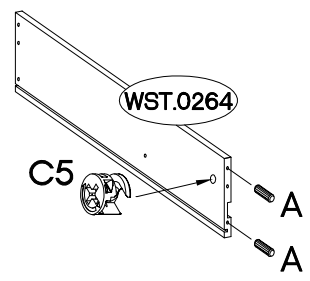
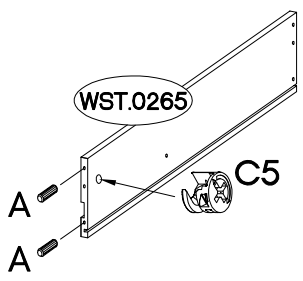
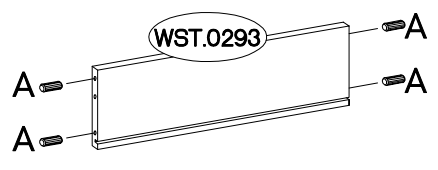
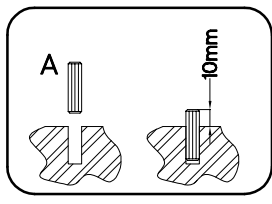
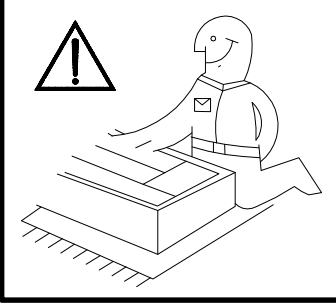

2

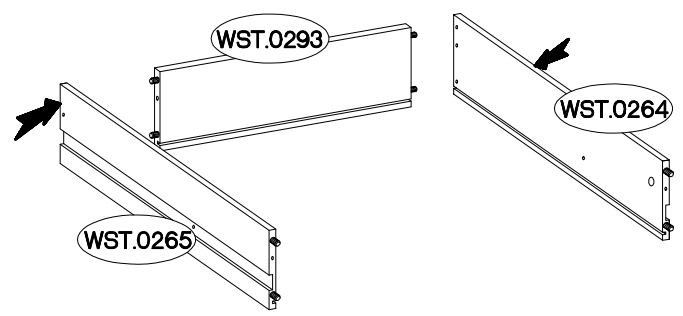

x2

<p>±6x42mm</p>  <p>B2</p> <p>4</p>
---

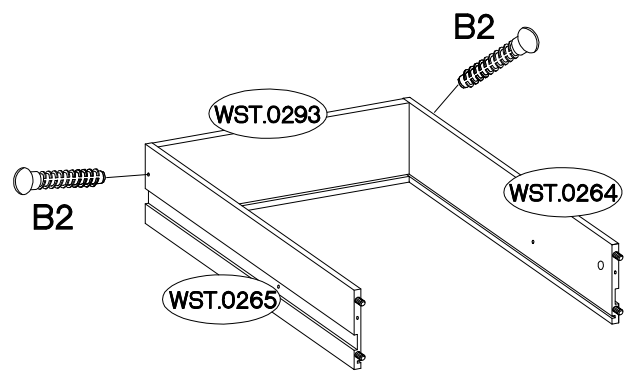
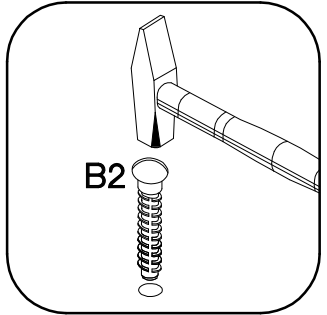

3

<p>L=20mm</p>  <p>D2</p> <p>4</p>
--

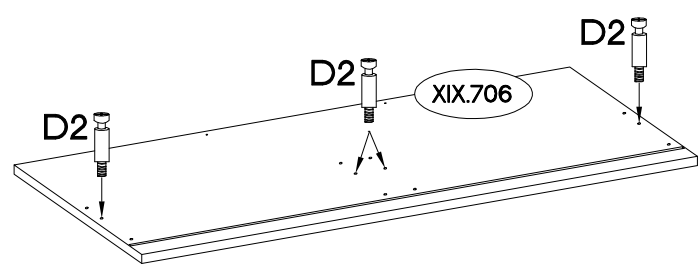
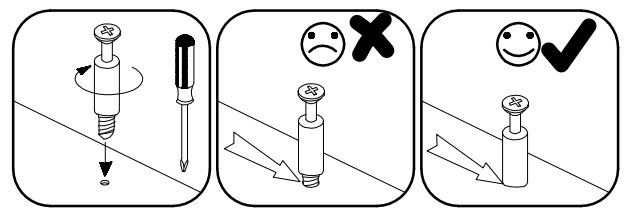



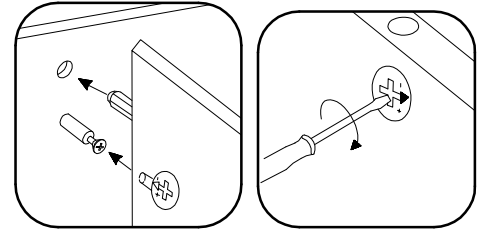
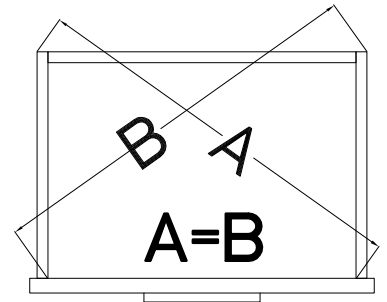
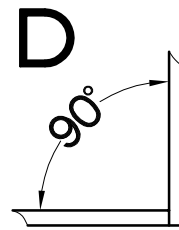
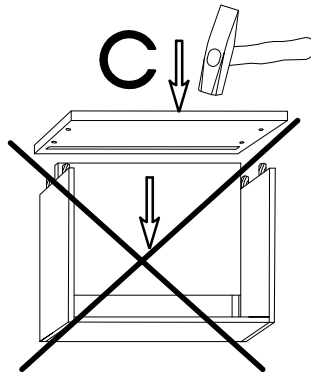
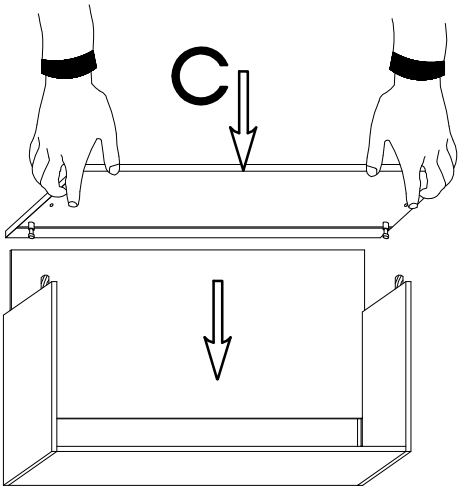
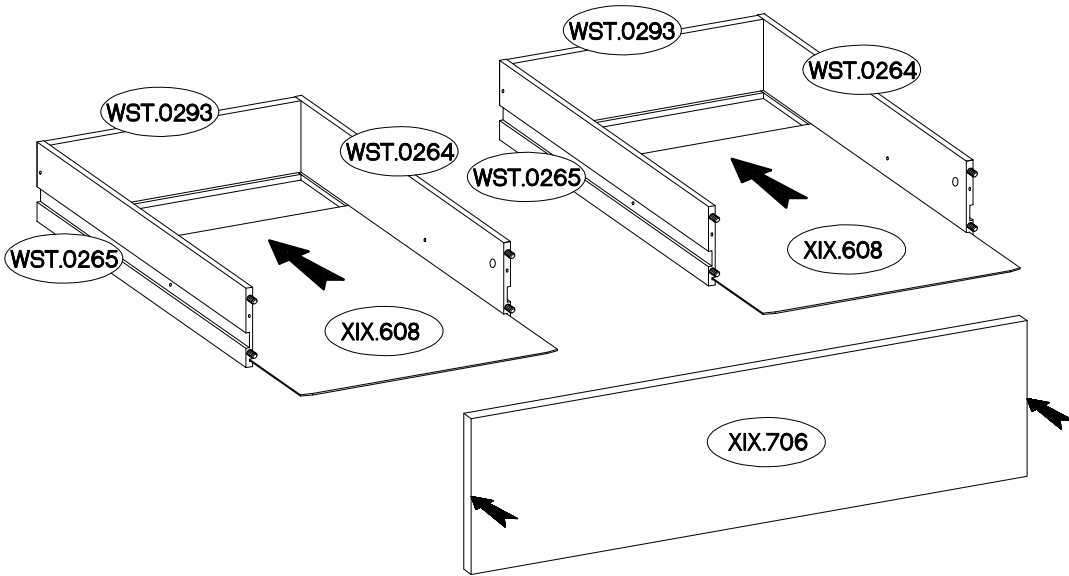
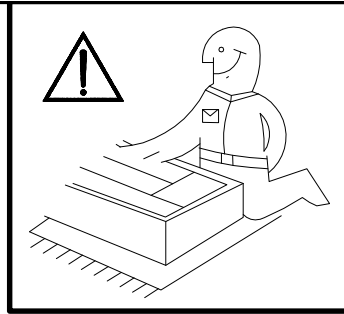

4

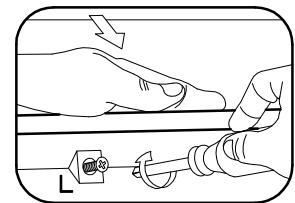
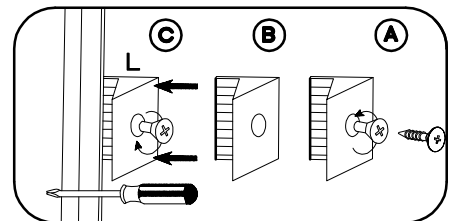
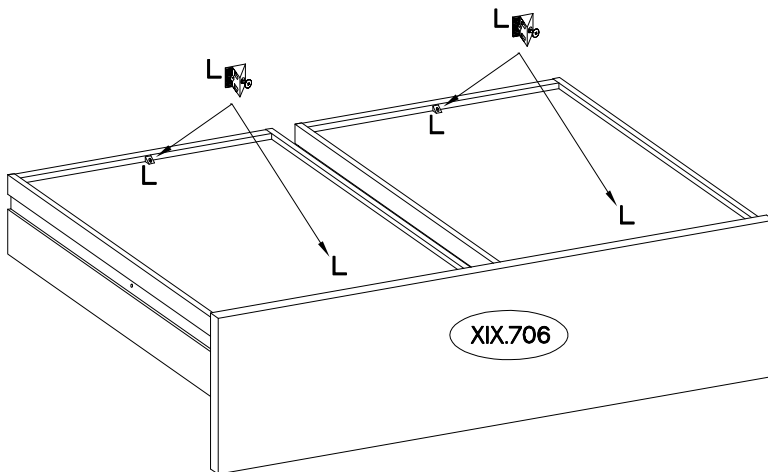
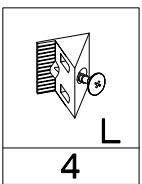



5

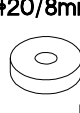

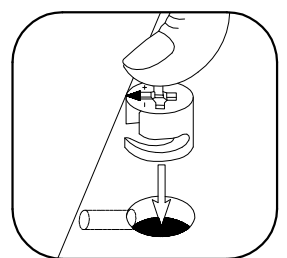
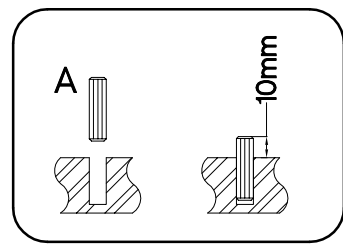
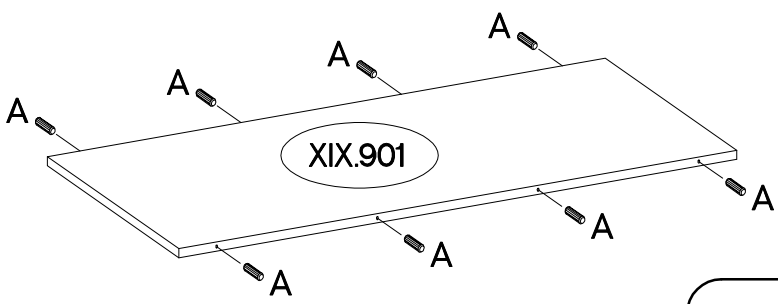
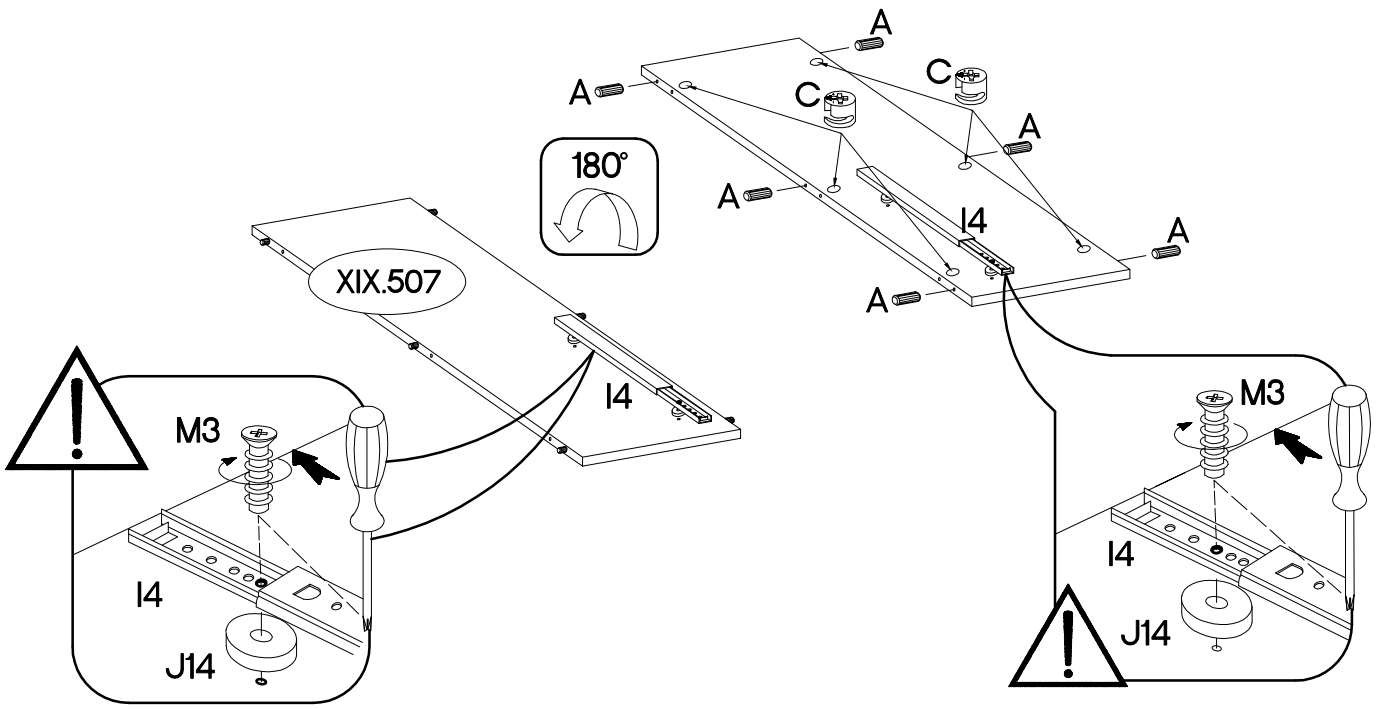
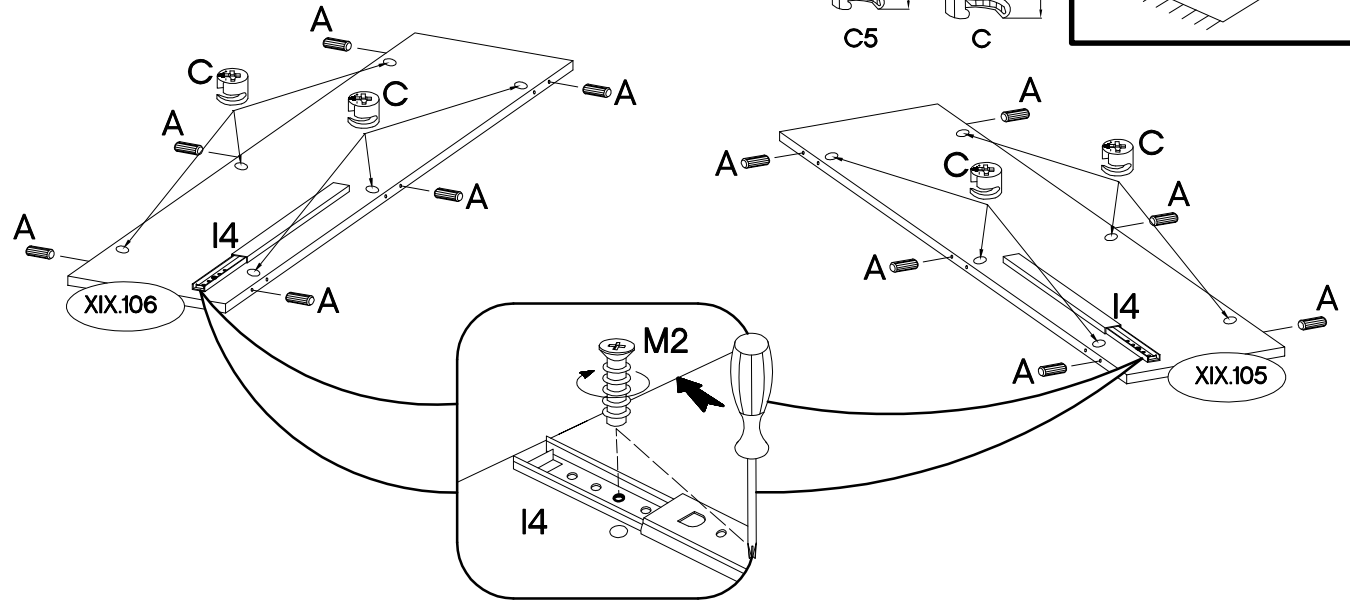
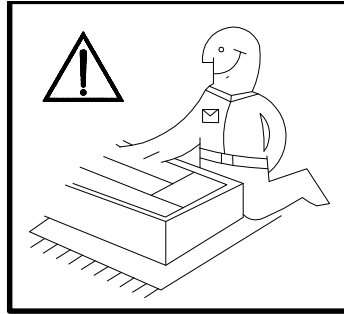
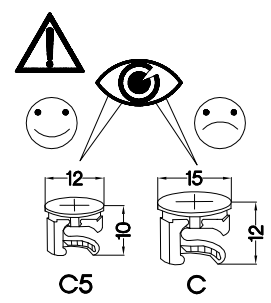
$\pm 8 \times 30 \text{mm}$  A 26	$\pm 15 / 12 \text{mm}$  C 18	$27 / 310 \text{mm}$  I4 2	$\pm 6,3 \times 13 \text{mm}$  M2 4	$\pm 6,3 \times 20 \text{mm}$  M3 4	$\pm 20 / 8 \text{mm}$  J14 4
--	--	---	--	--	--



7

L=130mm  F33 4	+4.0x16mm  R11 16	L=20mm  D2 9
---	--	---

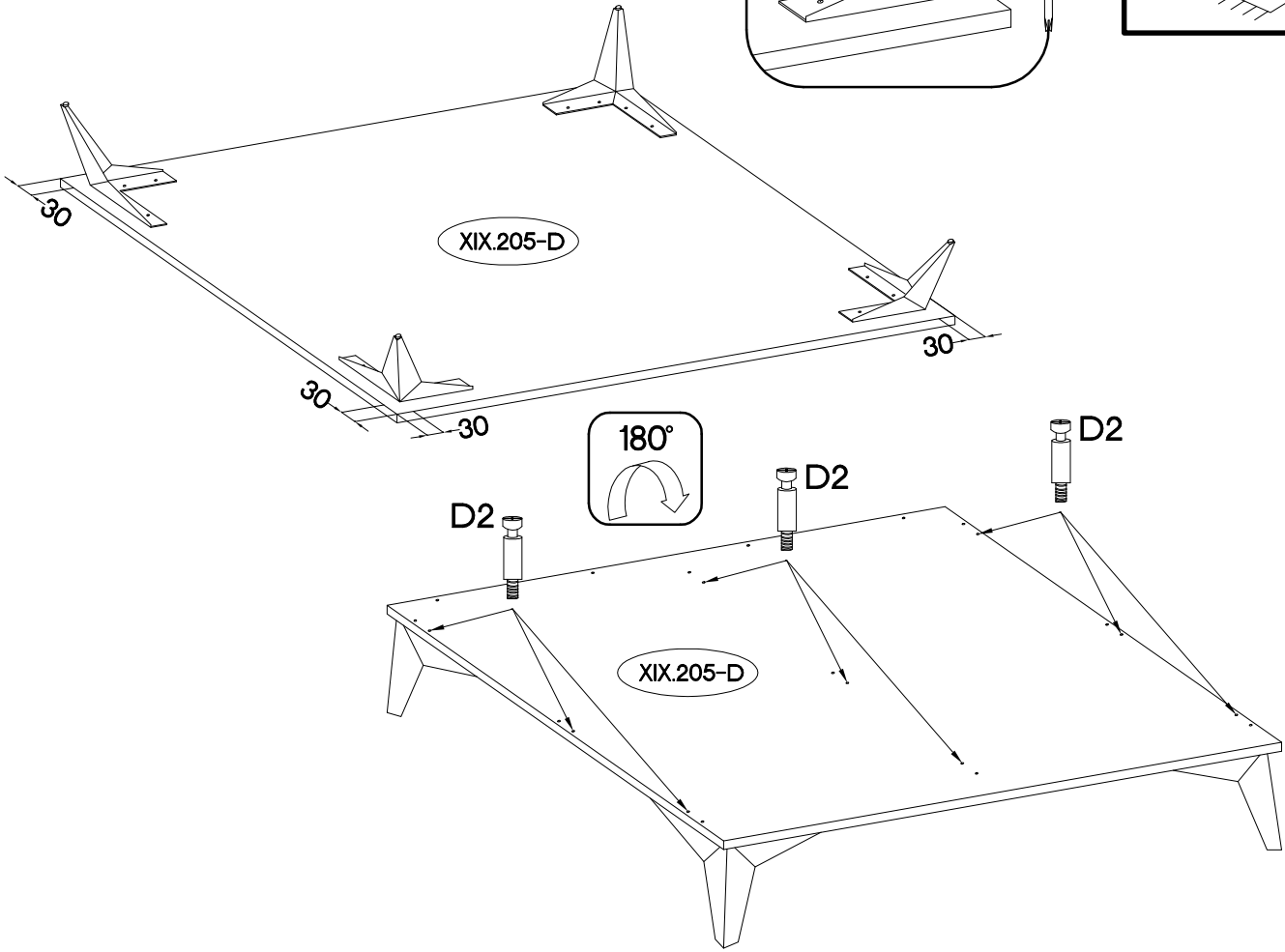
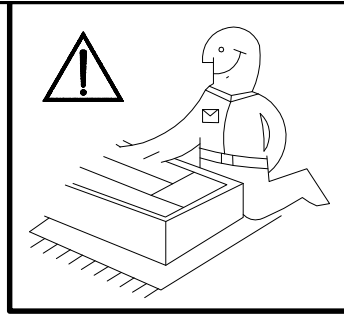
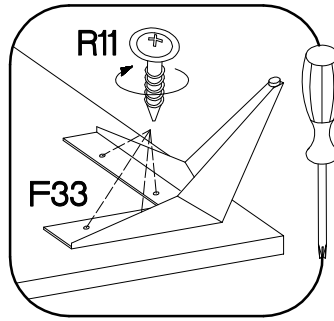

8

L=20mm  D2 9
--

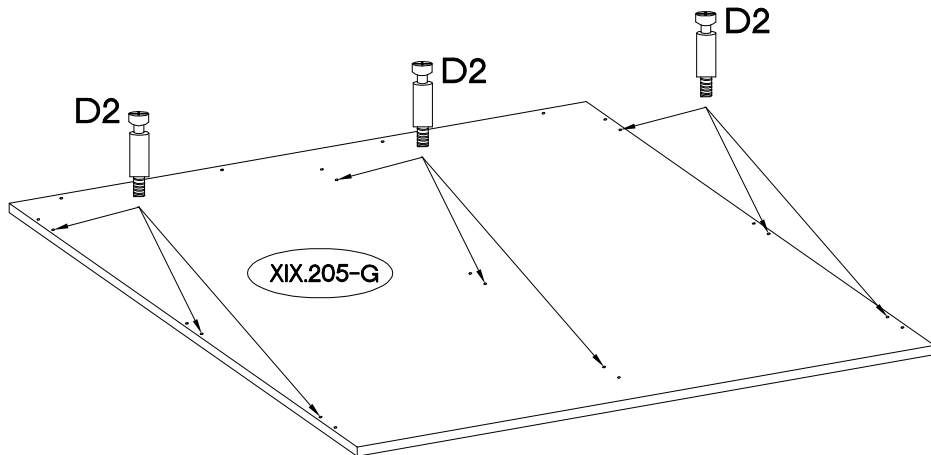

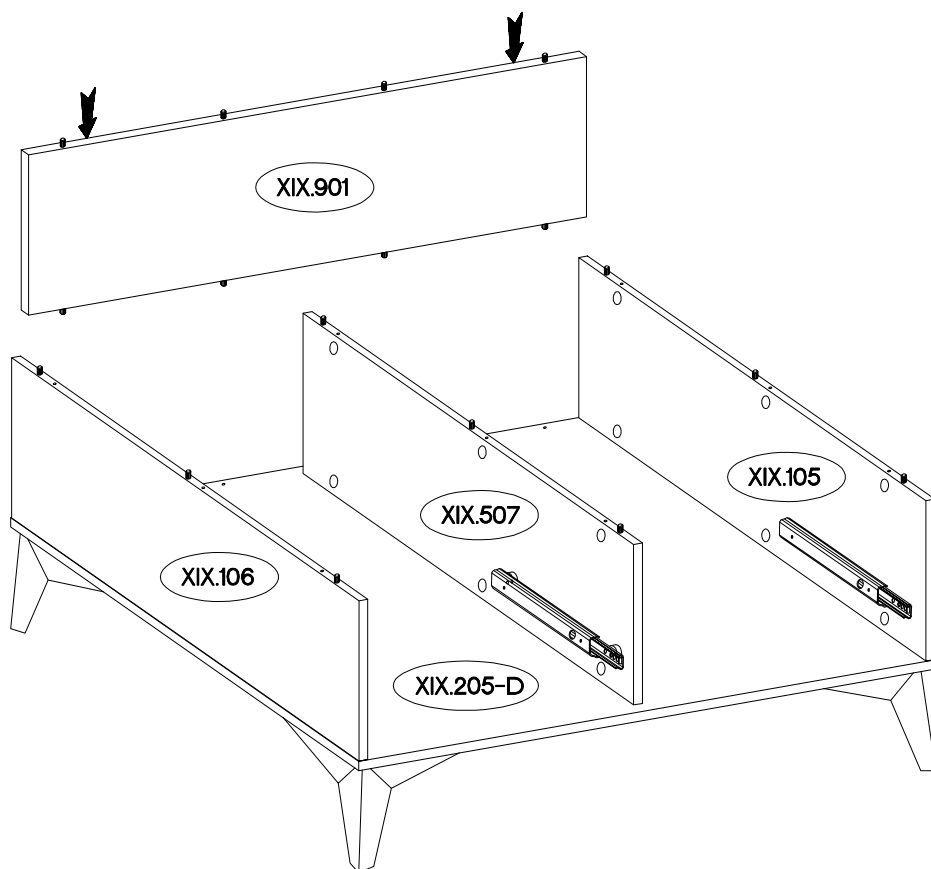
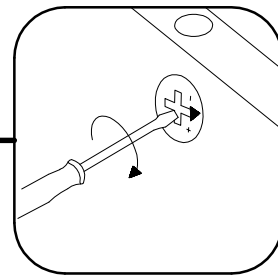
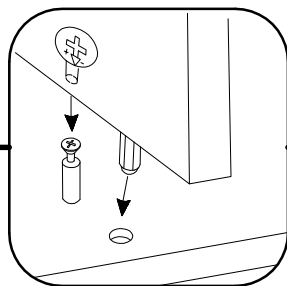
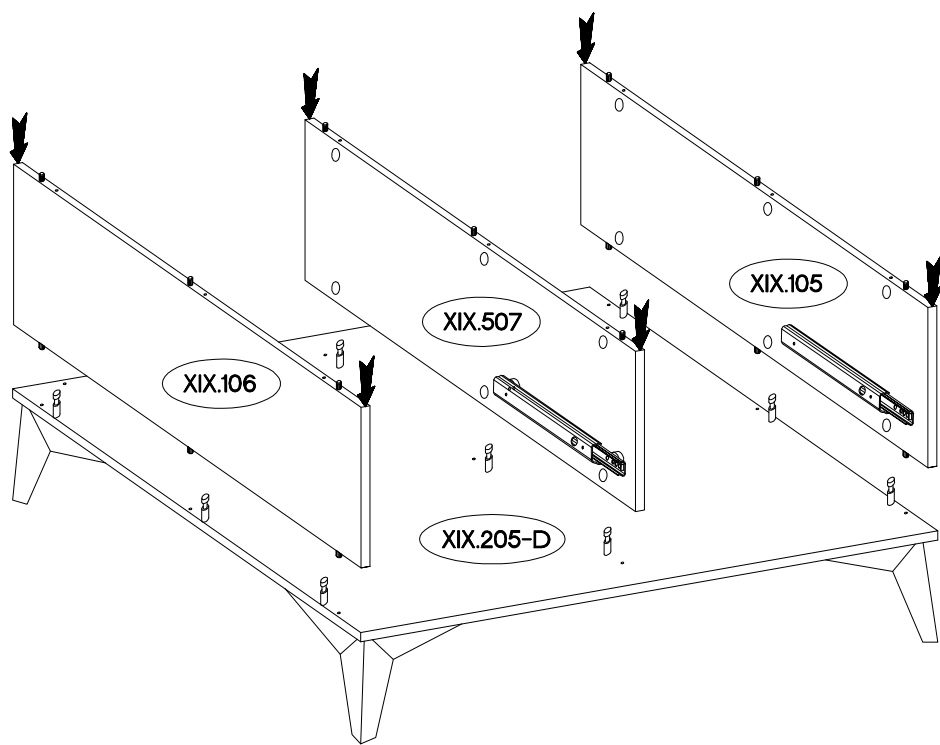

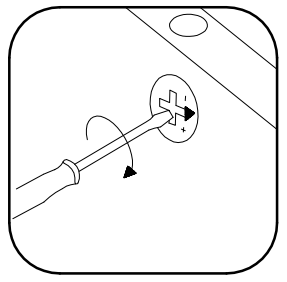
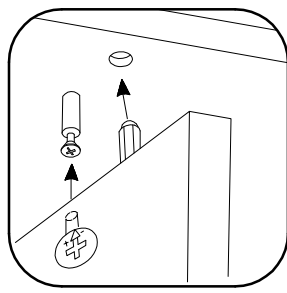
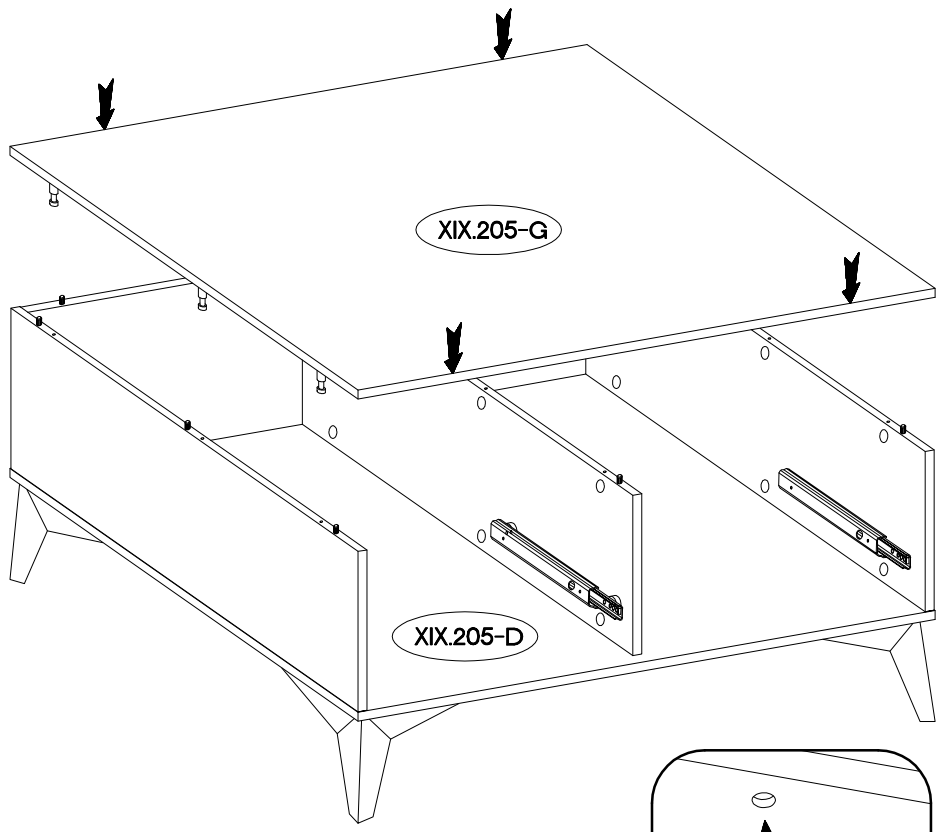

11

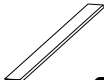

12

L=256mm	φ3.5x13mm	M4x9mm
 S	 P5	 U1
1	2	4

