

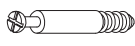





















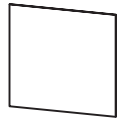



## Assembly Instructions

### 1 Hardware List

	A	M6x35mm	12pcs		B	Ø15x10mm	12pcs		C	Ø6x30mm	8pcs
	D	M3.5x12mm	32pcs		E	M4x35mm	12pcs		F	M6x28mm	8pcs
	G	M6x40mm	4pcs		H		2pcs		I		4pcs
	J	M4*12mm	4pc		K	M4mm	1pc		L		12pcs

### 2 Parts List

	①	1pc		②	1pc		③	1pc		④	1pc
	⑤	1pc		⑥	2pcs		⑦	2pcs		⑧	2pcs
	⑨	2pcs		⑩	2pcs		⑪	2pcs		⑫	2pcs
CR  DR 	⑬	2pcs	CL  DL 	⑭	2pcs						

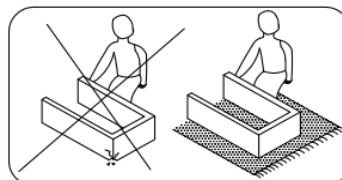
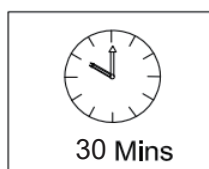
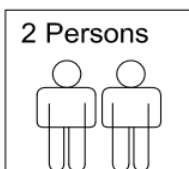

3

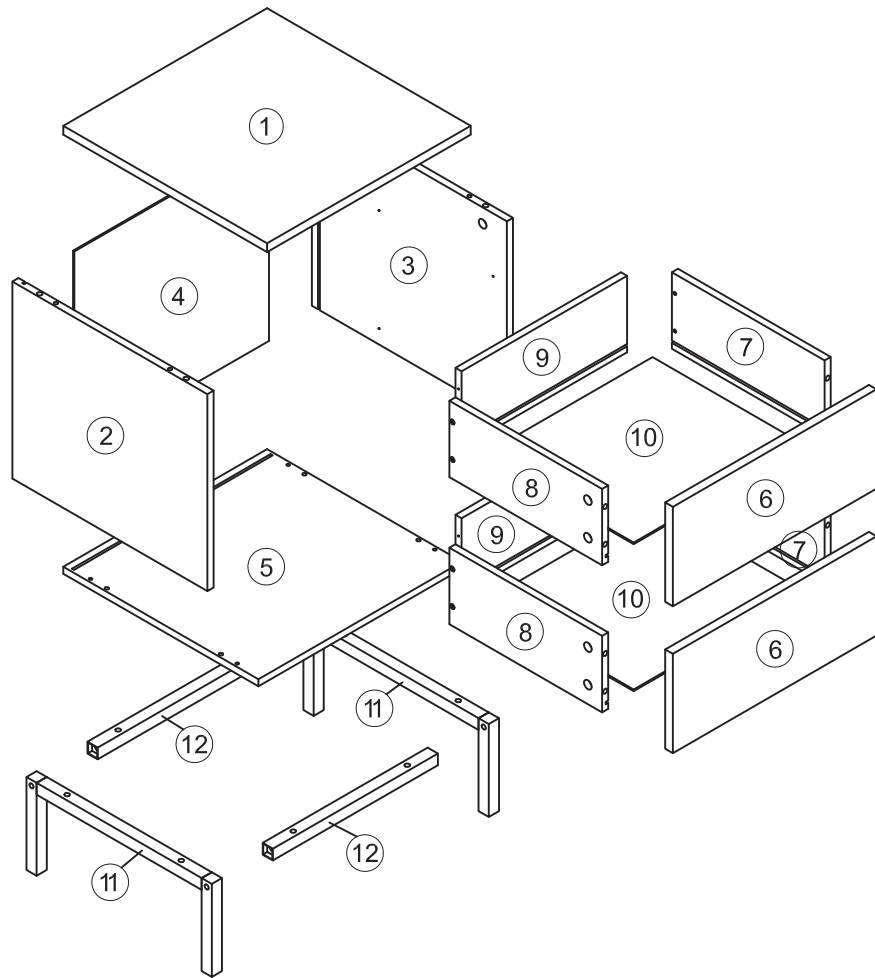



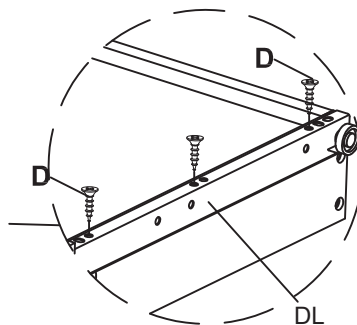
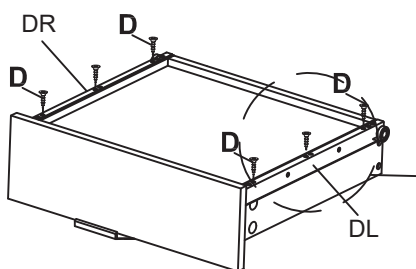
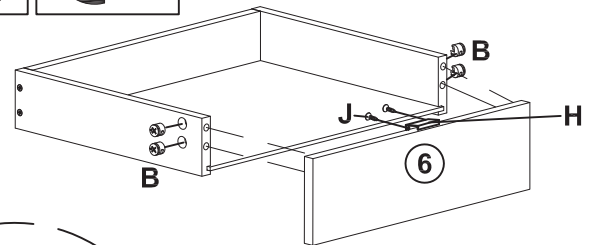
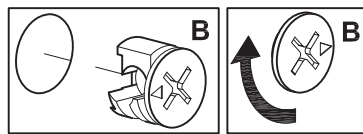
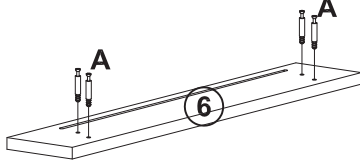
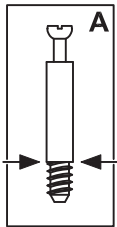
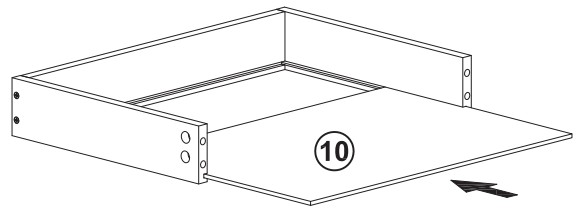
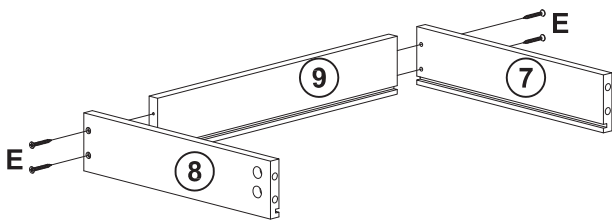

STEP 1 A - x 8 B - x 8 D - x 12 E - x 8 H - x 2 J - x 4

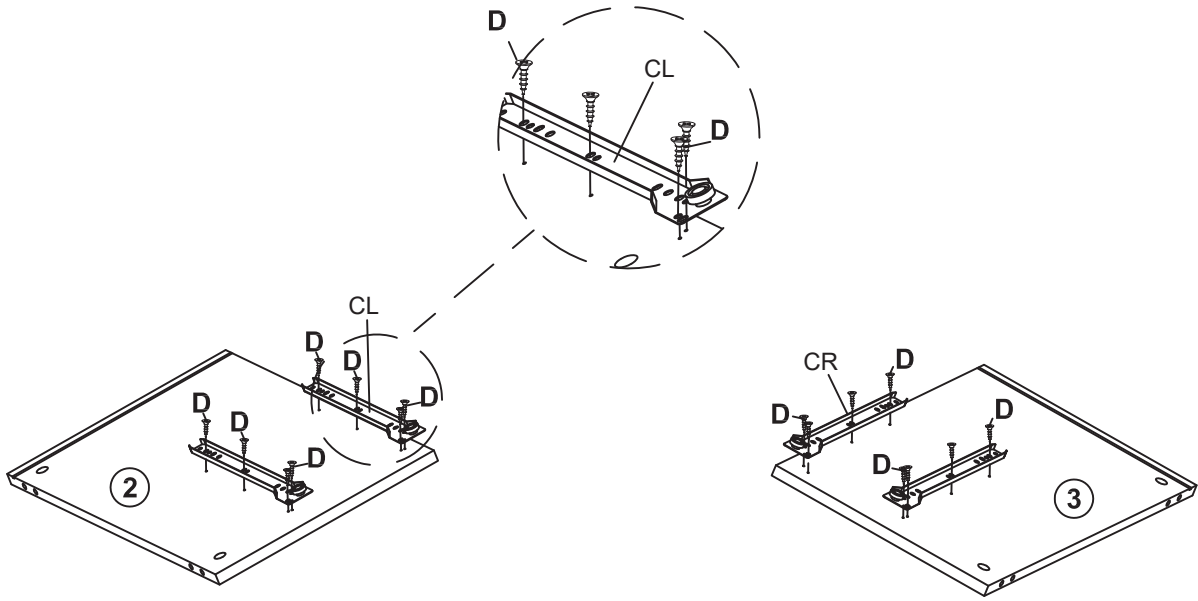

X2

STEP 2 **D -  x 16**



STEP 3 **A -  x 4** **B -  x 4** **C -  x 4**

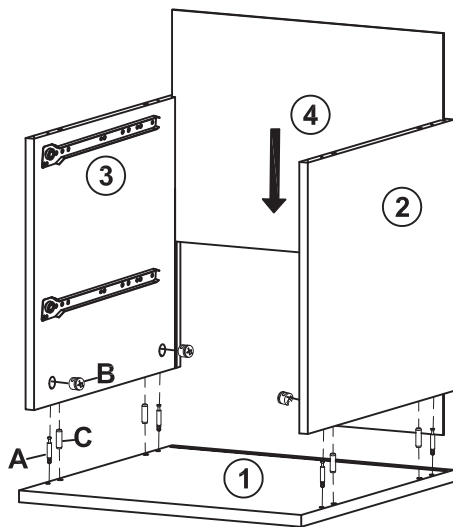

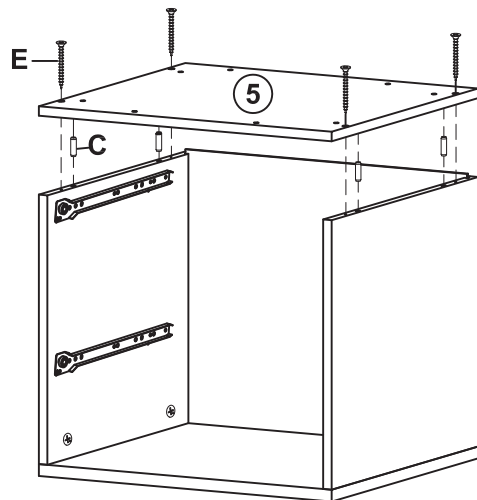

STEP 4 **C -  x 4** **E -  x 4**

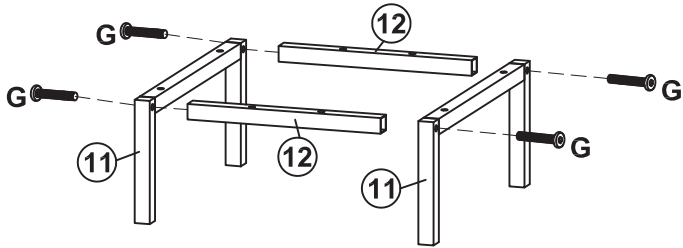

STEP 5 **G -  x 4** **K -  x 1**



STEP 6 **F -  x 8** **K -  x 1**

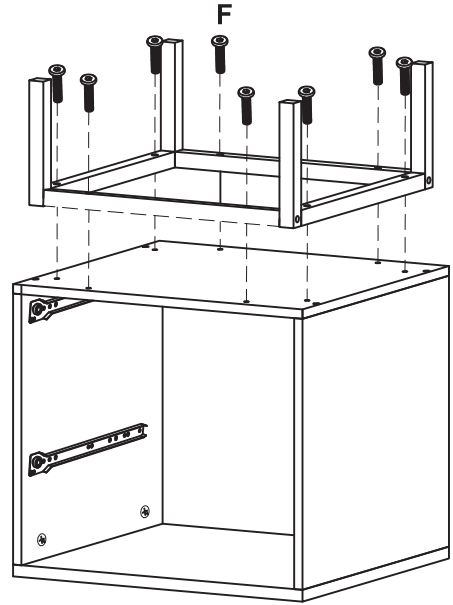

STEP 7 **L -  x 12**

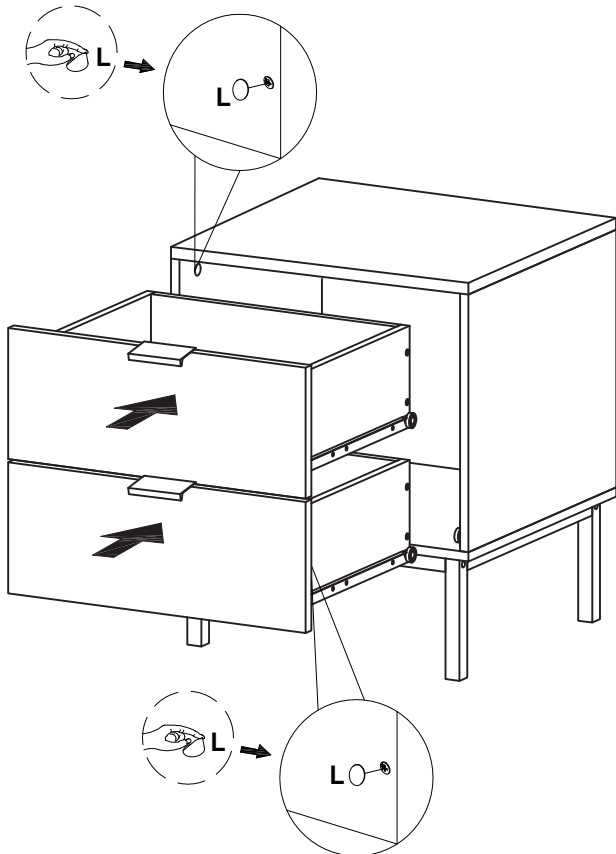

STEP 8 **D -  x 4** **I -  x 4**

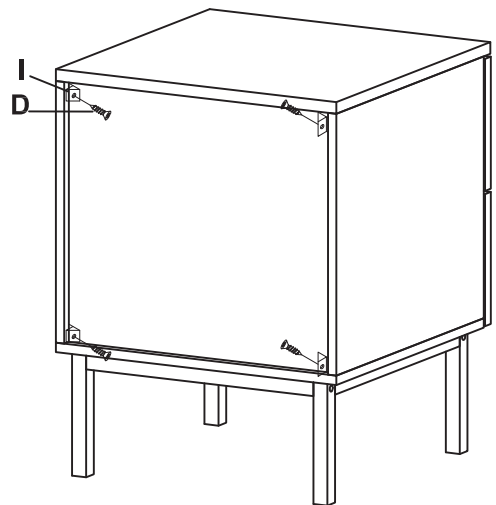

STEP 9

