

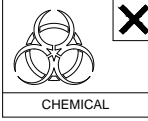

SOFT, DRY CLOTH

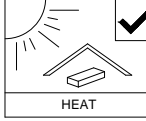

CHEMICAL



HEAT



KEEP DRY



HANDLE WITH CARE



DO NOT USE KNIFE

ASSEMBLY INSTRUCTION

MODEL : SC 864744 @ MILLIS DESCRIPTION : 3 DOORS SHOE CABINET

HARDWARE

A	B	C	D	E	F	G	H	I	J	K	L	M	N	O
WOOD DOWEL 8 X 25	MINIFIX - 12MM (HOUSING)	MINIFIX - 12MM (EURO 24)	MINIFIX CAP -12MM	CB SCREW M3X12MM	P/H SCREW M3.5X16MM	CB SCREW M4X20MM	NAIL 5/8	PVC NAIL WITH PIN 5/8	STOPPER 2 PIN	PVC HANDLE -64	2 TRAY SHOE CABINET -195 (LEFT)	2 TRAY SHOE CABINET -195 (RIGHT)	TRAY -NUT JOINER	TRAY -NUT JOINER
10	10	10	10	36	6	6	22	4	6	3	3	3	6	6

PART LIST

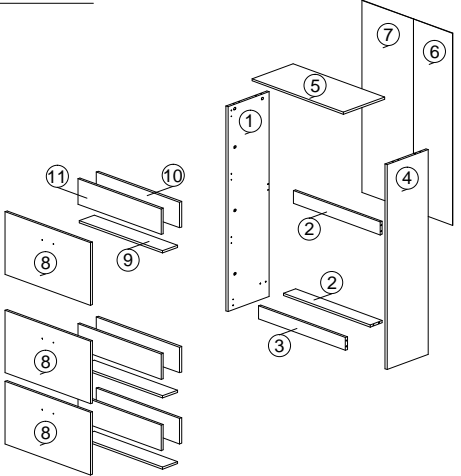

STEP 1

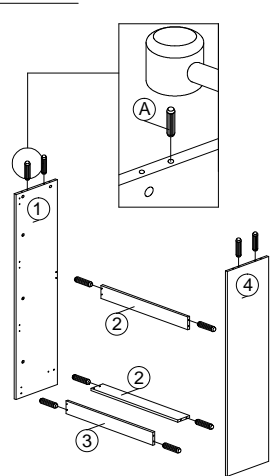

STEP 2

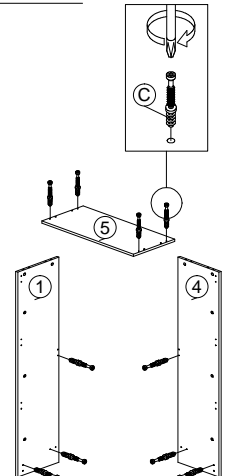

STEP 3

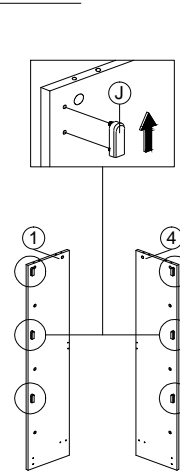

STEP 4

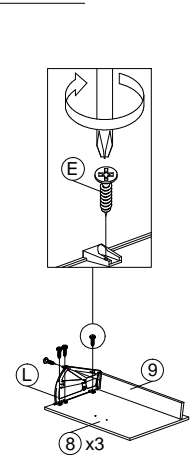

STEP 5

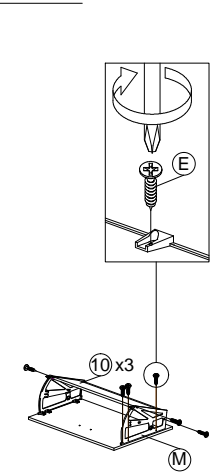

STEP 6

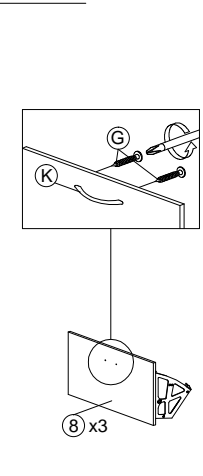

STEP 7

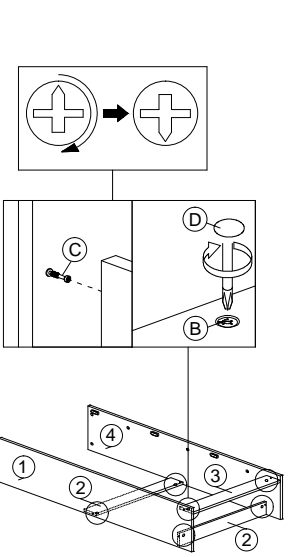

STEP 8

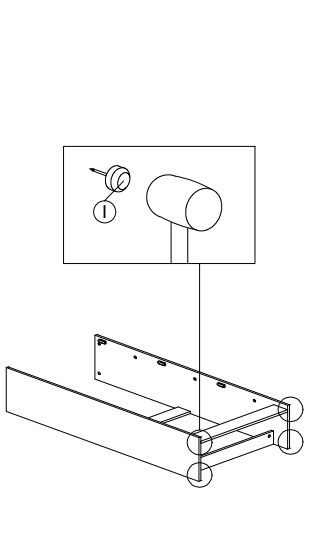

STEP 9

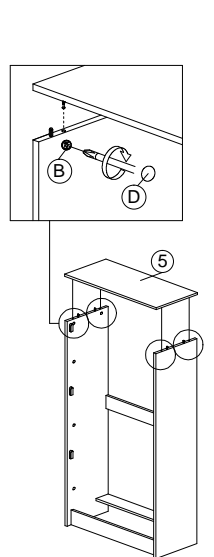

STEP 10

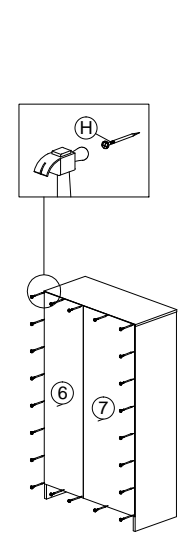

STEP 11

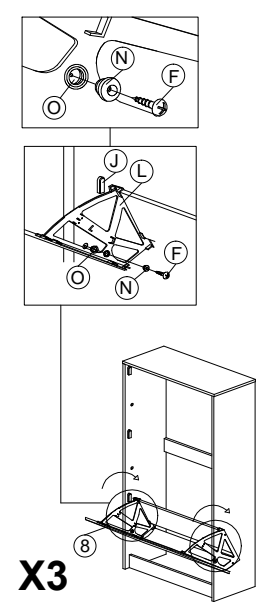

STEP 12

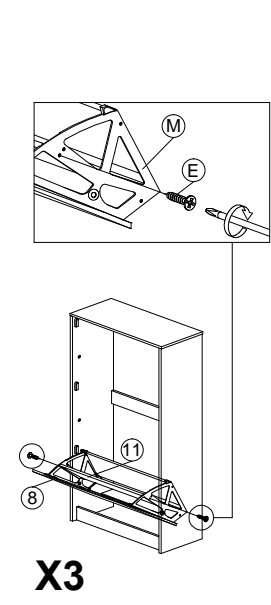

COMPLETED

