

60 DP-2100 2F

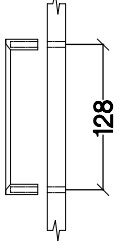

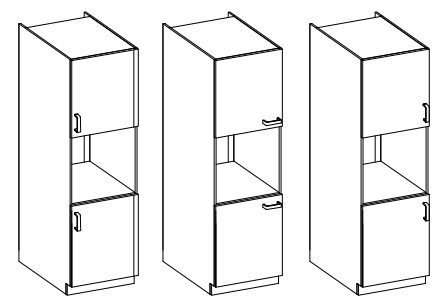

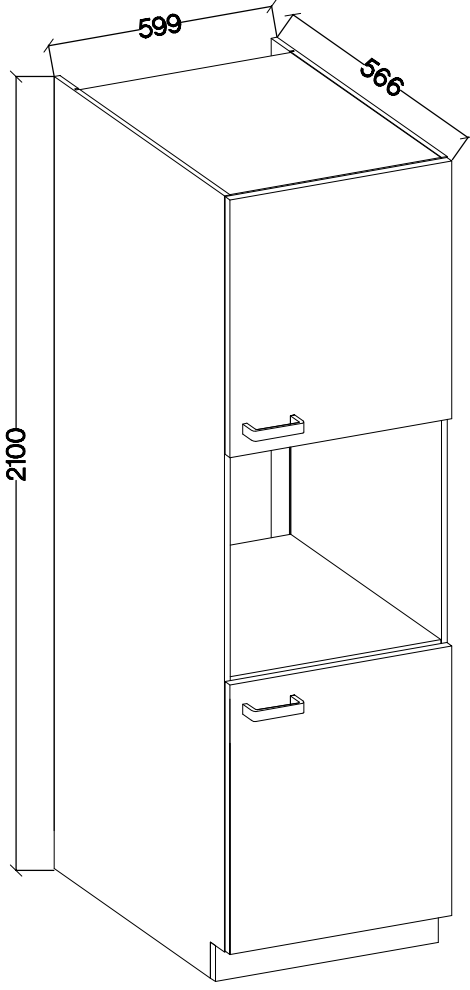
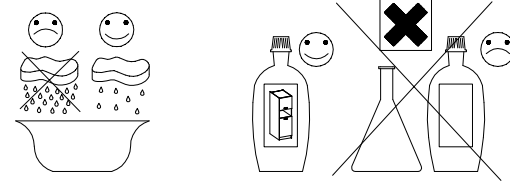
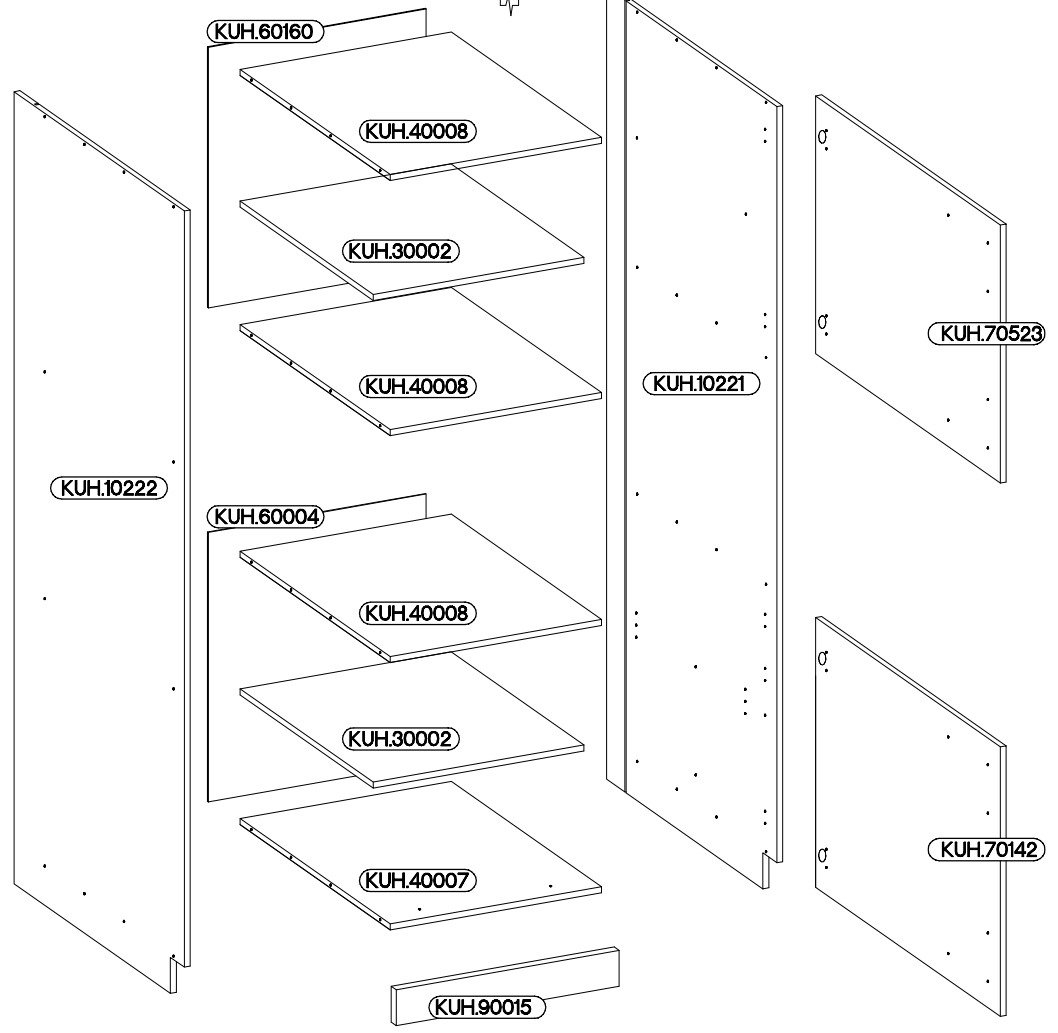
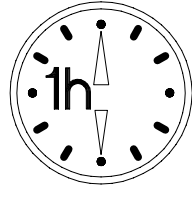

KUH.30002
KUH.40007
KUH.40008

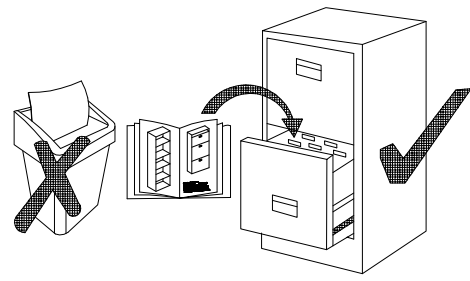

A	B	E1	E9	F2	HG	J
16	16	16	2	4	4	8
L25	O	P4	P5	P7	S23	U
1	1	2	10	15-20	2	4



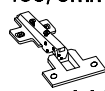

1

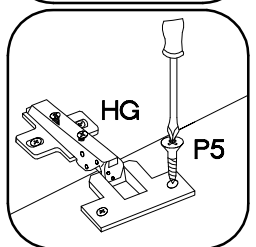
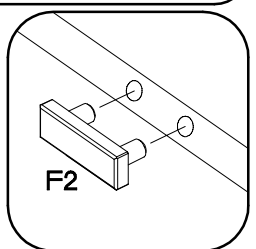
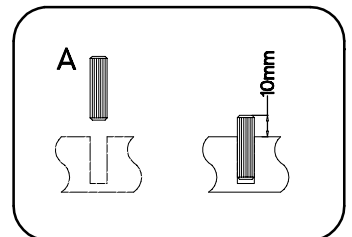
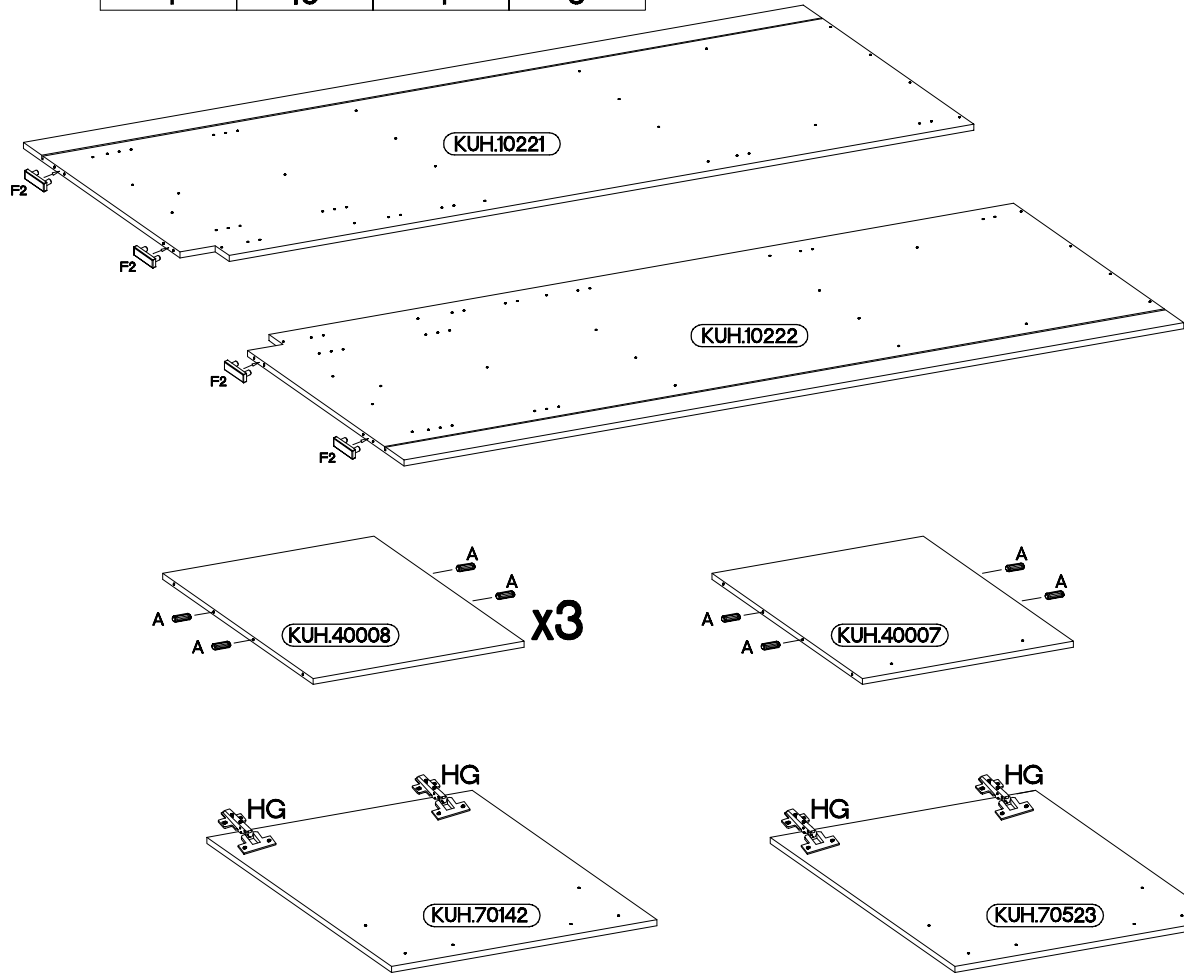
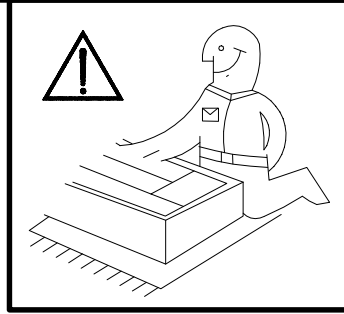
6.5x48x16	+8x30mm	+35/0mm	+3.5x13mm
			
F2	A	HG	P5
4	16	4	8

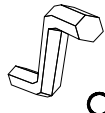

2

6,4 x 50mm			
	B	O	E1
	8	1	8

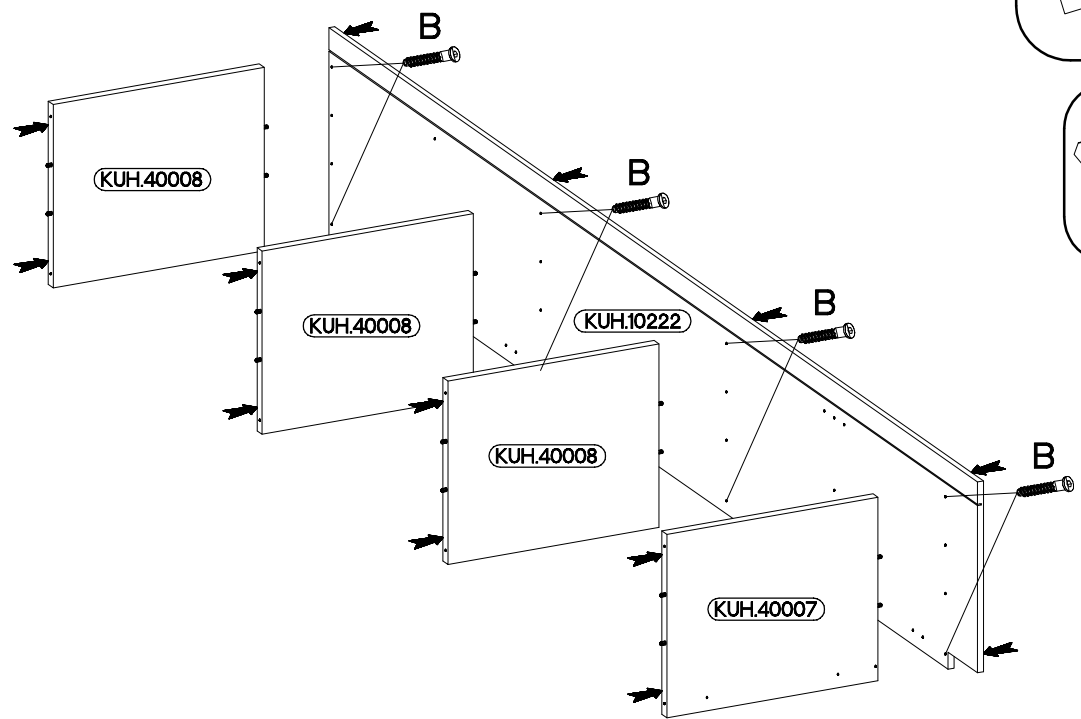
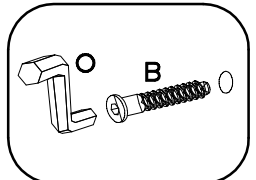
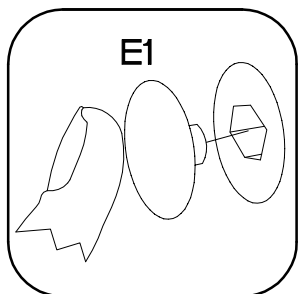

3

6,4 x 50mm

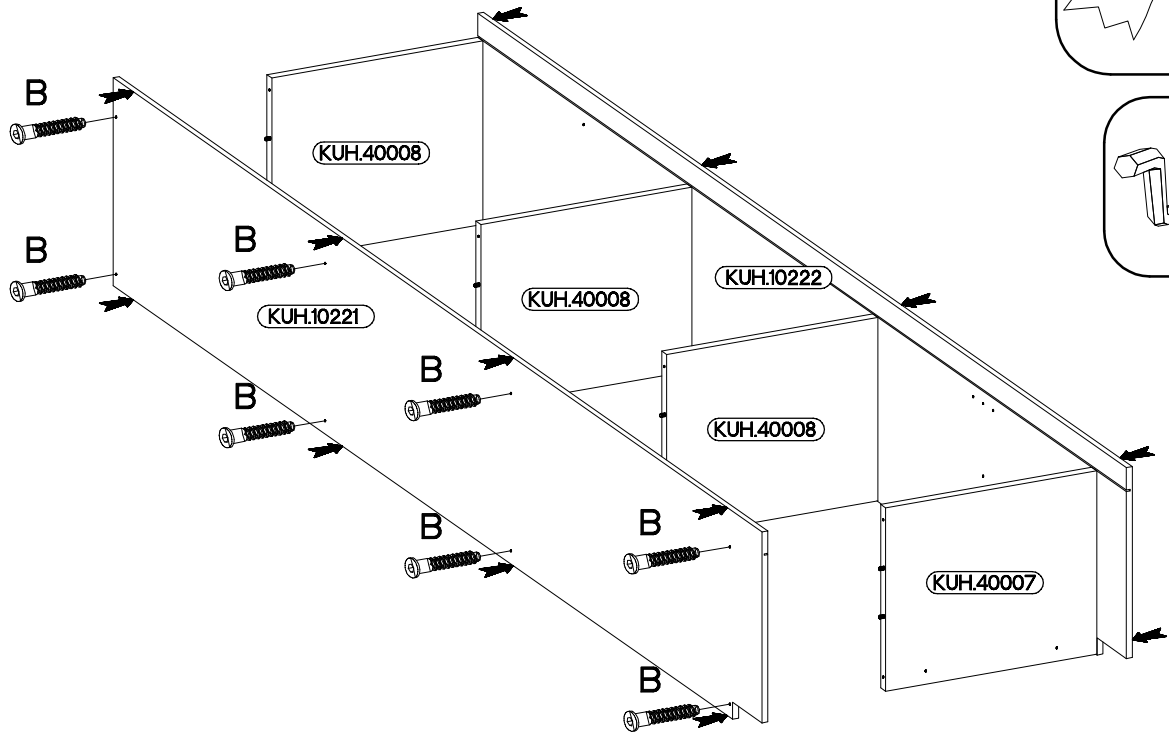
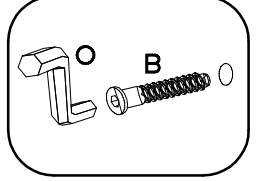
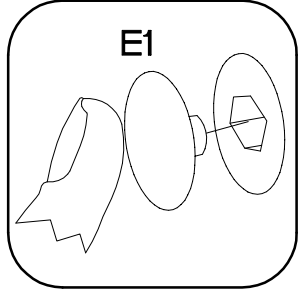
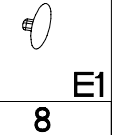
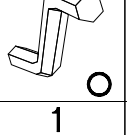
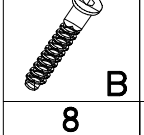

4

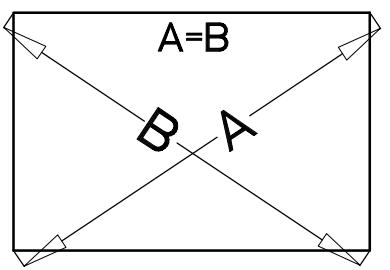
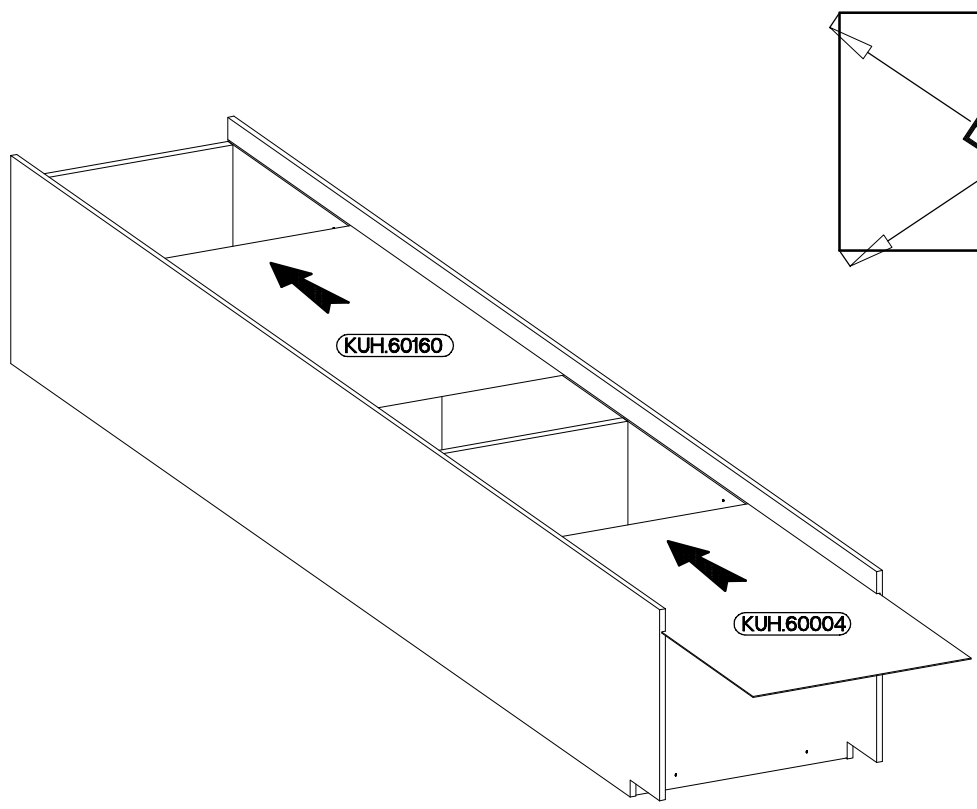

5

±3.0x20mm



P7

15-20

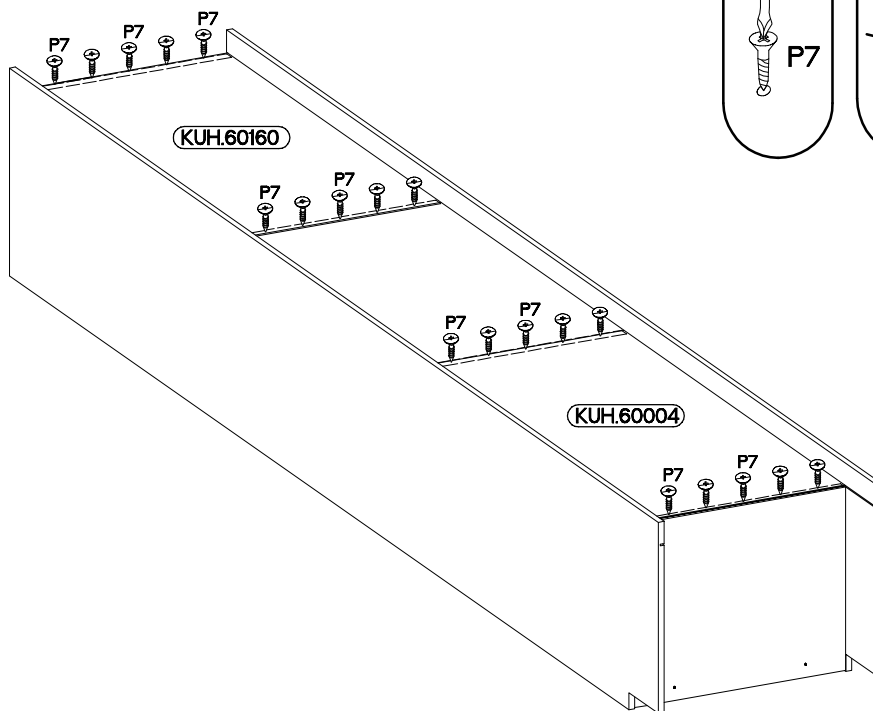
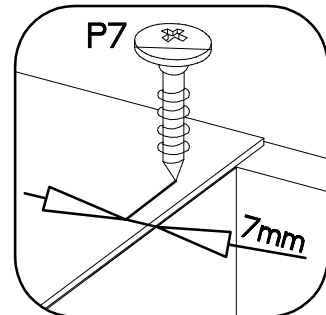
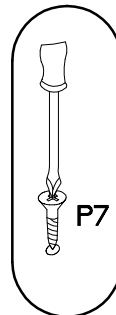

6

±4.0x45mm



P4

2



E9

2

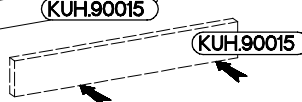
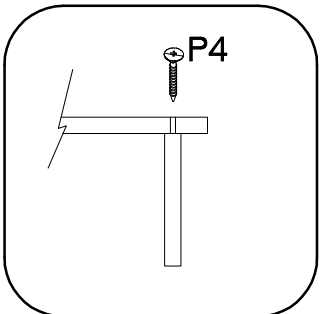
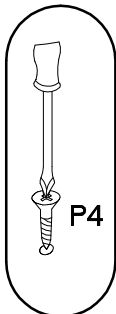
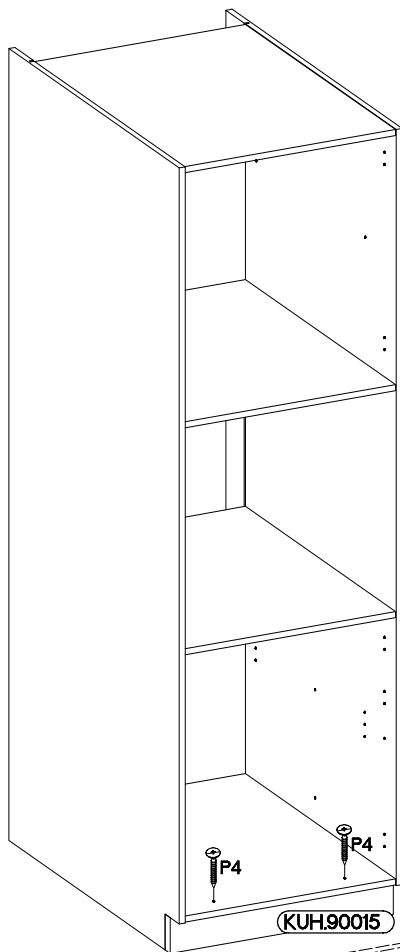

7

±5/19mm

J

8

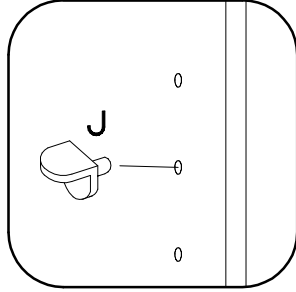
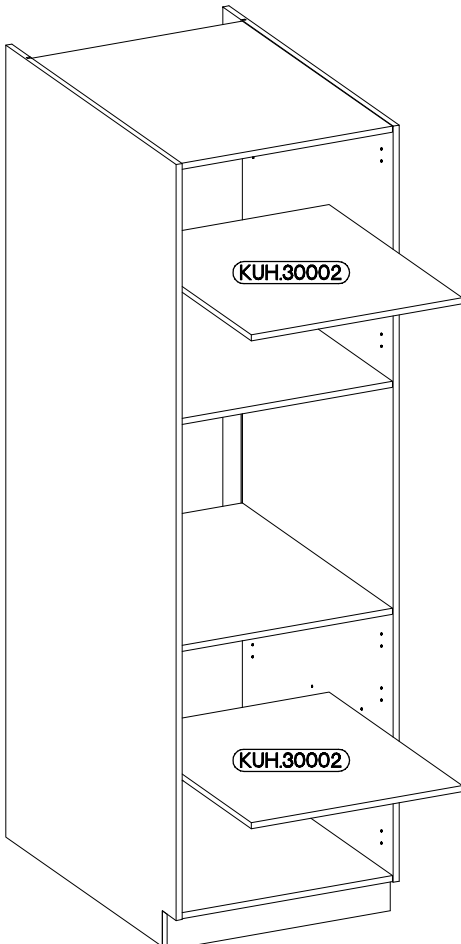

8

±3.5x13mm

L25

1

P5

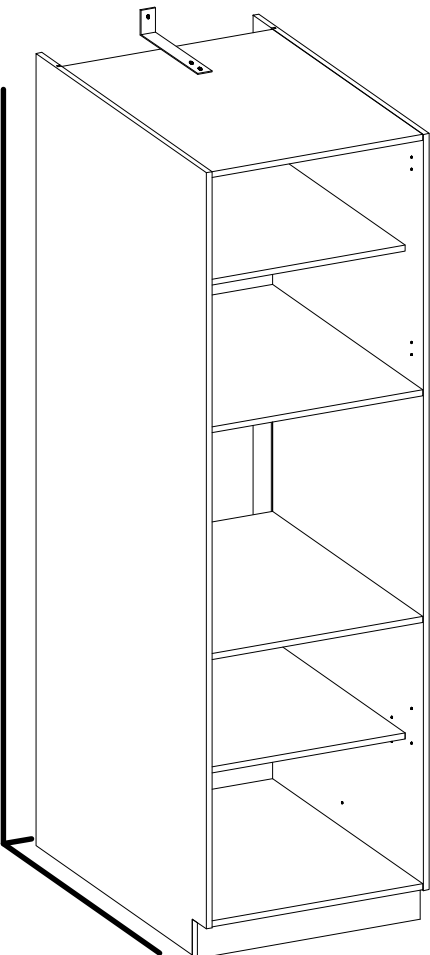

2

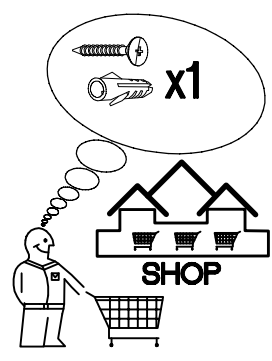
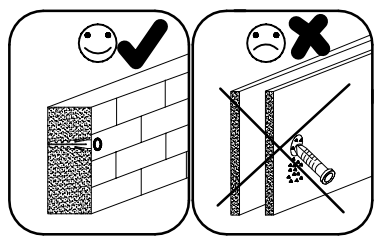

1. L25
2. Ø10mm
- 3.
4. L25
5. L25 P5 P5

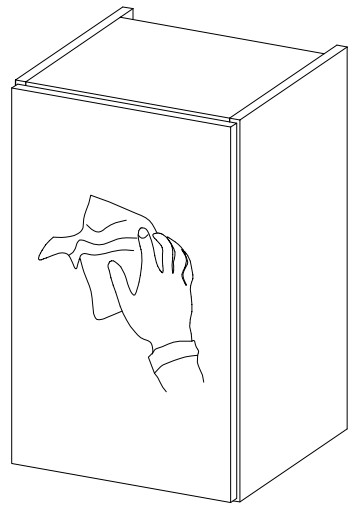
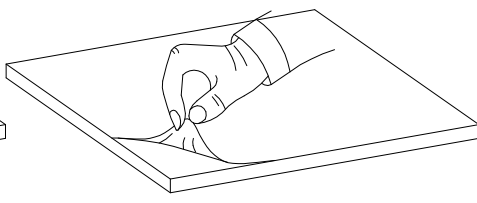
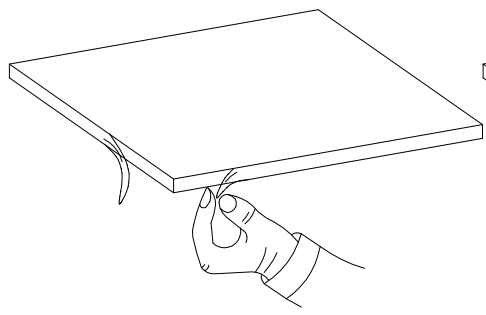
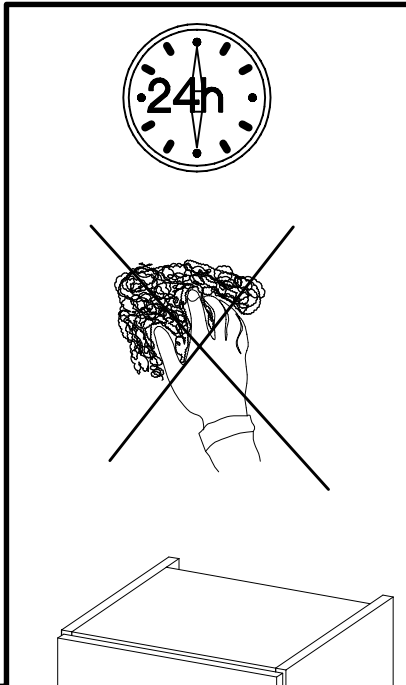
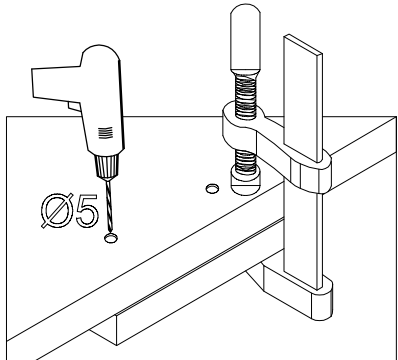
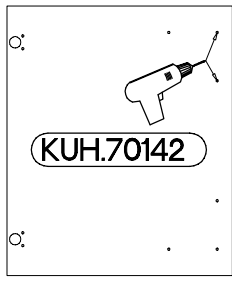
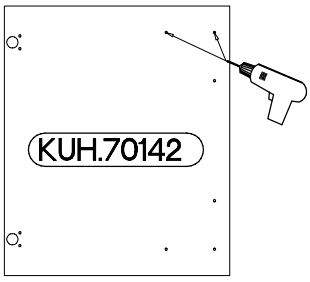
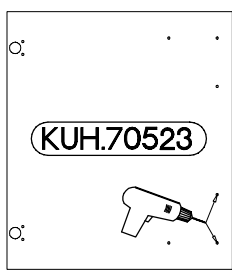
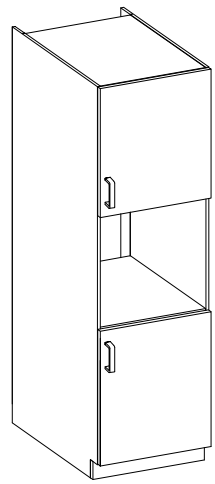
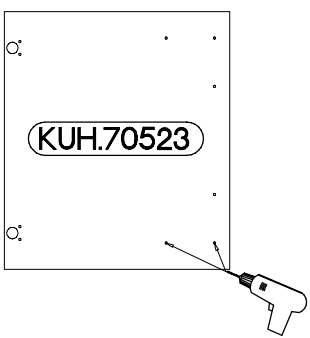
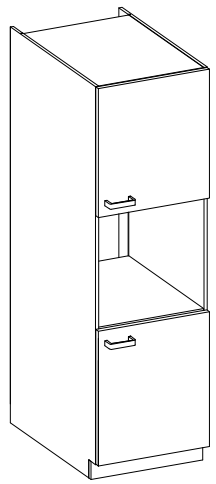
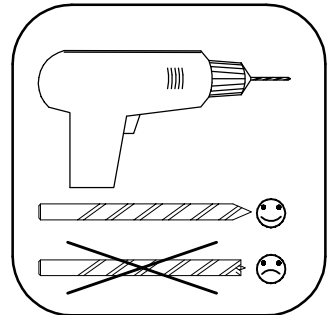
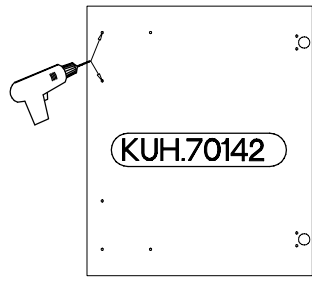
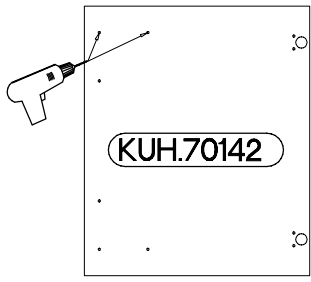
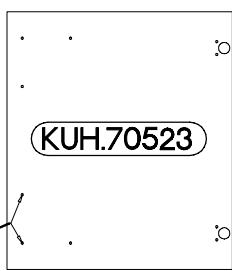
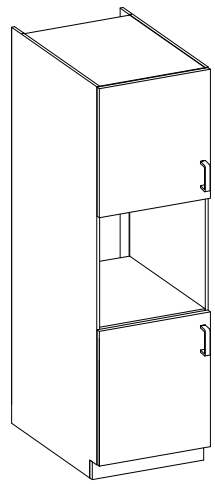
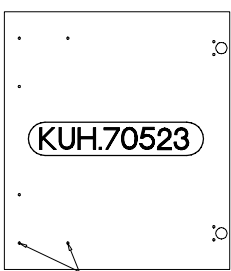
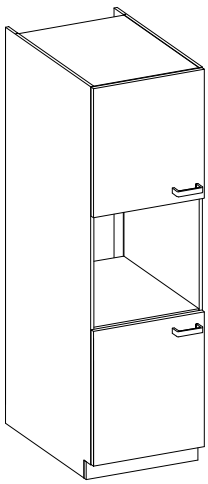



M4x22mm		
4	U	S23
		2

