

Edmond E

PL Instrukcja montażu
 DE Montageanleitung
 NL Handleiding voor de montage
 TR Montaj talimatı
 FR Notice de montage
 CZ Montážní návod
 HU Szerelési útmutató
 GB Assembly instructions
 RU Инструкция по монтажу
 IT Istruzioni di montaggio
 SK Návod na montáž
 RO Instrucțiuni de montaj
 ES Instrucciones de montaje
 PT Instruções de montagem

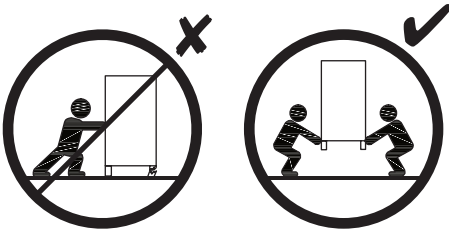
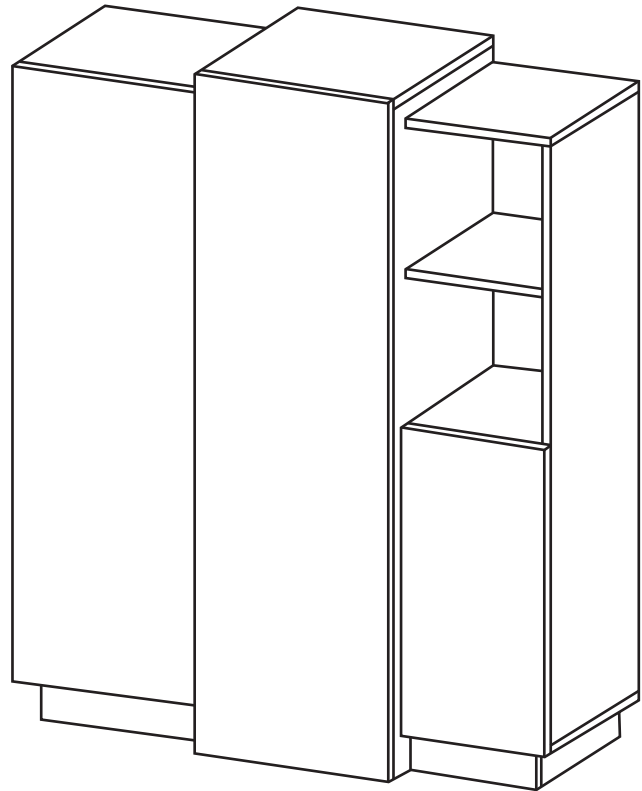

Producent - Produzent - Üretici - Producteur - Výrobce -
 Termelő - Producer - Produttore - Producător - Productor
MEBLE LASKI KACZOROWSKA
 Laski, ul. Kępińska 21, 63-620 Trzcinica
 meble-laski@meble-laski.com.pl

2025-01-03

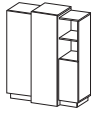

PL Przed rozpoczęciem montażu mebla wszystkie elementy należy sprawdzić czy nie są uszkodzone. W przypadku wykrycia uszkodzenia elementu należy odstąpić od montażu mebla i złożyć reklamację.

Nie wolno przekraczać podanych maksymalnych wartości obciążenia. W innym przypadku można mebel uszkodzić lub zniszczyć.

Przed zawieszeniem mebla, lub przymocowaniem go do ściany (w celu zabezpieczenia przed przewróceniem), sprawdź wcześniej rodzaj i wytrzymałość ściany. Dobierz odpowiednie kołki i wkręty do rodzaju ściany. W przypadku wątpliwości skontaktuj się ze specjalistą. Montaż musi zostać wykonany przez osobę kompetentną. Meble zawierające płyty drewnopochodne mogą emitować substancje zanieczyszczające do powietrza w pomieszczeniu. Dlatego zaleca się, po zamontowaniu mebli, częste wentrowanie pomieszczenia przez co najmniej cztery tygodnie.

DE Vor Beginn der Möbelmontage sollten alle Elemente auf Beschädigungen überprüft werden. Wenn ein Element des Produkts beschädigt ist, installieren Sie das Produkt bitte nicht und reichen Sie eine Beschwerde ein. Überschritten Siedieangegebenen Maximalbelastungen nicht. Andernfalls kann das Möbelstück beschädigt oder zerstört werden.

Bevor Sie ein Möbelstück an einer Wand aufhängen oder befestigen (um es gegen Umkippen zu sichern), prüfen Sie Art und Tragfähigkeit der Wand. Wählen Siediefür dieWand geeigneten Dübel und Schrauben. Im Zweifelsfall kontaktieren Sie bitte einen Fachmann. Die Montagemus durch eine sachkundige Person ausgeführt werden. Möbel mit Holzwerkstoffplatten können Schadstoffe in die Raumluft abgeben, daher Es wird empfohlen, den Raum nach dem Einbau der Möbel mindestens vier Wochen lang häufig zu lüften.

FR Avant de commencer l'assemblage du meuble, tous les éléments doivent être vérifiés pour détecter tout dommage. Si un élément du produit est endommagé, veuillez ne pas installer le produit et déposer une plainte.

Ne dépassez pas les charges maximum indiquées. Sinon, le meuble peut être endommagé ou détruit. Avant de suspendre le meuble ou de le fixer au mur (dans le but d'éviter un renversement), vérifiez au préalable le type et la résistance du mur. Utilisez les chevilles et les vis adaptées au type de mur. En cas de doute, veuillez contacter un spécialiste. Le montage doit être réalisé par une personne compétente.

Les meubles contenant des panneaux à base de bois peuvent émettre des substances polluantes dans l'air intérieur. Donc il est recommandé, après l'installation des meubles, d'aérer fréquemment la pièce pendant au moins quatre semaines.

CZ Před zahájením montáže nábytku je třeba zkontrolovat poškození všech prvků. Pokud je některý prvek produktu poškozen, zdržte se instalace produktu a podejte stížnost.

Nepřekračujte uvedené maximální zatížení. V opačném případě může dojít k poškození nebo zničení nábytku. Před zavěšením nábytku nebo jeho připevněním ke zdi (za účelem zajištění před převrácením) dříve zkontrolujte druh a odolnost stěny. Vyberte k druhu stěny vhodné hmoždinky a šrouby. V případě pochybností kontaktujte specialistu. Montáž musí být provedena kompetentní osobou.

Nábytek obsahující panely nabází dřevomateriálu mohou uvolňovat znečišťující látky dovnitř místnosti. Proto doporučujeme se po instalaci nábytku místnost pravidelně větrat po dobu nejméně čtyř týdnů.

HU A bútör szerelés megkezdése előtt ellenőrizni kell az összes elem sérülését. Ha a termék bármely eleme megsérült, kérjük, tartózkodjon a termék telepítésétől és nyújtson bepanaszt.

A megadott maximális terhelési értékeket nem szabad túllépni. Ellenkező esetben a bútör megsérülhet vagy megsemmisülhet. A bútör felfüggesztése illetve falhoz való rögzítése (megakadályozzván az eldőléseinek lehetőségét) előtt ellenőrizze a fal fajtáját és szilárdságát. Megfelelő, a falhoz illő tipjelket és csavarokat használjon. Ha kétségetámadna, konzultáljon szakemberrel. A felszerelés csakis egy hozzáértő szakember végezheti el.

A fa alapú paneleket tartalmazó bútörök szennyező anyagokat bocsáthatnak ki a beltéri levegőbe. Ezért Ajánlott a bútörök beszerelése után legalább négy hétig rendszeresen szellőztetni a helyiséget.

GB Before starting the furniture assembly, all elements should be checked for damage. If any element of the product is damaged, please refrain from installing the product and file a complaint.

The specified maximum load values must not be exceeded. Otherwise, the piece of furniture may be damaged or destroyed.

Before suspending or fixing furniture to the wall (in order to prevent falling over), check the type and strength of the wall. Select wall plugs and screws appropriate for the given type of the wall. In the case of doubts, contact a specialist. The installation must be performed by a competent person.

Furniture containing wood-based panels can emit polluting substances into the indoor air. Therefore recommended, after installing the furniture, to ventilate the room frequently for at least four weeks.

SK Pred začatím montáže nábytku by sa mali skontrolovať všetky prvky, či nie sú poškodené. Ak je niektorý prvok výrobku poškodený, neinstalujte výrobok a reklamujte ho.

Uvedené hodnoty maximálneho zaťaženia nesmú byť prekročené. V opačnom prípade môže dôjsť k poškodeniu alebo zničeniu nábytku.

Pred zavesením nábytku alebo jeho pripavením na stenu (za účelom zaistenia pred prevrátením) predtým zkontrolujte druh a odolnosť steny. Vyberte k druhu steny vhodné hmoždinky a skrutky. V prípade pochybností kontaktujte špecialistu. Montáž musí byť vykonaná kompetentnou osobou.

Nábytek obsahujúci dosky nabáza drevomateriálu môžu uvoľňovať znečisťujúce látky do vnútorného ovzdušia. Preto odporúča sa po inštalácii nábytku miestnosť pravidelne vetrať aspoň štyri týždne.

IT Prima di iniziare l'assemblaggio del mobile, tutti gli elementi dovrebbero essere controllati per danni. Se qualche elemento del prodotto è danneggiato, astenersi dall'installare il prodotto e presentare un reclamo.

I valori di carico massimo specificati non devono essere superati. In caso contrario, il mobile potrebbe essere danneggiato o distrutto.

Prima di appendere mobili, oppure attaccarli al muro (per proteggerli dal ribaltamento), verificare il tipo di muro e la resistenza del muro. Scegli i tasselli e i viti più adatti per il tipo di muro. In caso di dubbi contattare uno specialista. Il montaggio deve essere fatto da una persona competente.

I mobili contenenti pannelli a base di legno possono emettere sostanze inquinanti nell'aria interna. Perciò si consiglia, dopo aver installato i mobili, di aereare frequentemente il locale per almeno quattro settimane.

NL Voordat u met de meubelmontage begint, moeten alle elementen op schade worden gecontroleerd. Als een onderdeel van het product beschadigd is, installeer het dan niet en dien een klacht in.

Overschrijd de aangegeven maximale belastingen niet. Anders kan het meubelstuk worden beschadigd of vernield.

Voordat u het meubel ophangt of bevestigt tegen de muur (om het te beschermen tegen omvallen) dient u het type en de duurzaamheid van deze muur na te kijken. Maak gebruik van pluggen en schroeven die geschikt zijn voor het type muur. Neem in geval van twijfels contact op met een specialist. De assemblagedient te worden uitgevoerd door iemand met kennis van zaken.

Meubels met panelen op houtbasis kunnen vervuilstoffen in de binnenlucht uitstoten. Daarom Het is raadzaam om na het plaatsen van het meubilair de ruimte minimaal vier weken regelmatig te ventileren.

TR Mobilya montajına başlamadan önce tüm elemanlarda hasar olup olmadığını kontrol edilmelidir. Ürünün herhangi bir parçası hasar görmüşse, lütfen ürünü kurmayın ve şikayette bulunun.

Belirlenilen azami yük degerini asmayınız, aksi takdirde mobilya parçaları zarar görebilir veya kullanılamaz hale gelebilir.

Mobilyayı duvara asmadan veya montaj etmeden önce (devrilmesini önlemek için) duvarın türünü ve dayanıklılığını kontrol edin. Duvar auygun dübelleri ve vidaları seçin. Emin olamamanız durumunda bir uzman ile iletişime geçin. Kurulum yetkili bir kişi tarafından yapılmalıdır.

Aşğıpazlı paneller içeren mobilyalar için mekan havasını kirlendiren maddeler yayabilir. Öyleyse Mobilyaların kurulumundan sonra odanın azdört hafta boyunca sık havalandırılması önerilir.

RO Înainte de a începe asamblarea mobilierului, toate elementele trebuie verificate pentru a nu se deteriorează. Dacă vreun element al produsului este deteriorat, vă rugăm să vă abțineți de la instalarea produsului și să depuneți o reclamație.

Valoriile maxime de sarcină specificate nu trebuie depășite. În caz contrar, piesa de mobilier poate fi deteriorată sau distrusă.

Înainte de suspendarea unei piese de mobilier sau atașarea acestuia la perete (pentru a preveni bascularea), verificați în prealabil tipul și gradul de rezistență a peretelui. Montați diblurile și șuruburile adecvate pentru tipul de perete. În caz de îndoieli, consultați un specialist. Instalarea trebuie să fie efectuată de către o persoană competentă.

Mobilierul care conține panouri din lemn poate emite substanțe poluante în aerul interior. Prin urmare se recomandă, după montarea mobilierului, aerisirea frecventă a încăperii timp de cel puțin patru săptămâni.

ES Antes de comenzar el montaje de los muebles, todos los elementos deben comprobarse en busca de daños. Si algún elemento del producto está dañado, absténgase de instalar el producto y presente una queja.

No se deben exceder los valores de carga máxima especificados. De lo contrario, el mueble puede dañarse o destruirse.

Antes de colgar o fijar el mueble en el muro (a fin de proteger contra el vuelco del mueble), compruebe de antemano la naturaleza y la resistencia de la pared. Seleccione tacos y tornillos adecuados para el tipo de la pared. En caso de duda, consulte a un especialista, debiendo efectuar este montaje una persona competente.

Los muebles que contienen paneles de madera pueden emitir sustancias contaminantes al aire interior. Por lo tanto se recomienda, después de instalar los muebles, ventilar la habitación con frecuencia durante al menos cuatro semanas.

PT Antes de iniciar a montagem do móvel, todos os elementos devem ser verificados quanto a danos. Se algum elemento do produto estiver danificado, evite instalar o produto e apresente uma reclamação.

Os valores de carga máxima especificados não devem ser excedidos. Caso contrário, o móvel pode ficar danificado ou destruído.

Antes de suspender ou fixar móveis à parede (para evitar quedas), verifique o tipo e a resistência da parede. Selecione buchas e parafusos adequados ao tipo de parede. Em caso de dúvida, contate um especialista. A instalação deve ser realizada por uma pessoa competente.

Os móveis que contêm painéis de madeira podem emitir substâncias poluentes para o ar interior. Assim, recomenda-se, após a instalação dos móveis, ventilar o ambiente frequentemente durante pelo menos quatro semanas.

RU Прежде чем приступить к сборке мебели, следует проверить все элементы на предмет повреждений. Если какой-либо элемент продукта поврежден, воздержитесь от установки продукта и подайте жалобу.







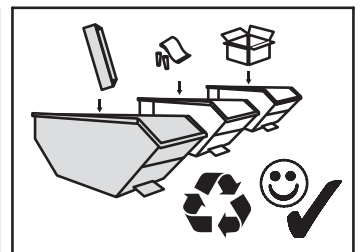
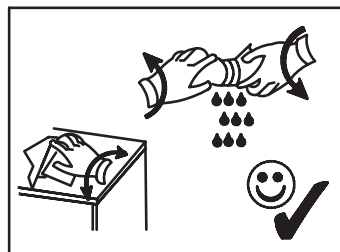
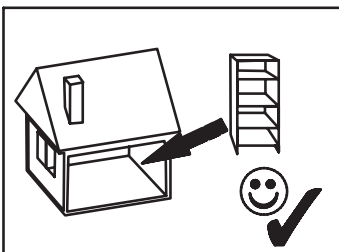
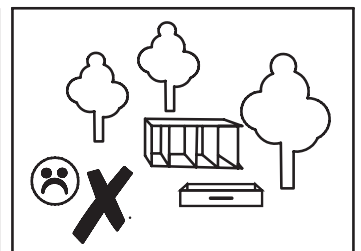
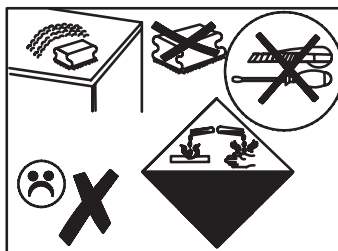
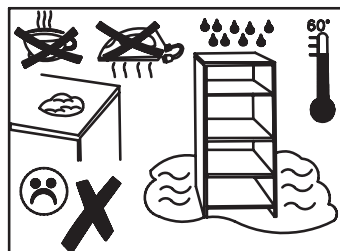
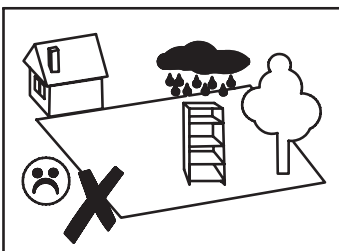

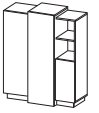
Указанные максимальные значения нагрузки превышать нельзя. В противном случае предмет мебели может быть поврежден или разрушен.

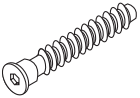
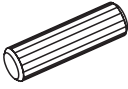
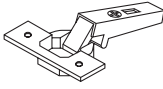
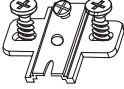
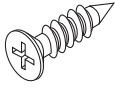
Прежде чем подвешивать или крепить мебель к стене (во избежание падения), проверьте тип и прочность стены. Выбирайте дюбели и шурупы, подходящие для данного типа стены. В случае сомнений обратитесь к специалисту. Установка должна выполняться компетентным лицом.

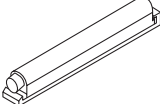
Мебель, состоящая из древесных плит, может выделять загрязняющие вещества в воздух в помещении. Поэтому рекомендуется после установки мебели часто проветривать помещение в течение как минимум четырех недель.



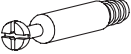
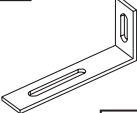
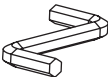

A  7 x 50 mm x 26	B  8 x 32 mm x 30	C  (P) x 6	DT  x 6	E  3,5 x 13 mm x 19	E2  3 x 20 mm x 48
G2  x 12	O2  x 3	P  x 28	Q2  Ø 20 x 14	R  H=11 mm x 10	U  L=24,3 mm x 10
W1  x 1	XA  x 1	ZA  Ø 4 x 22	ZR  Ø 15 x 10		

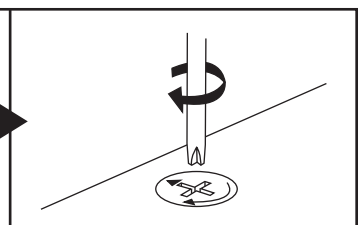
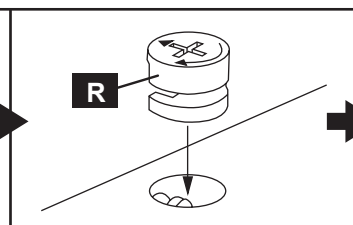
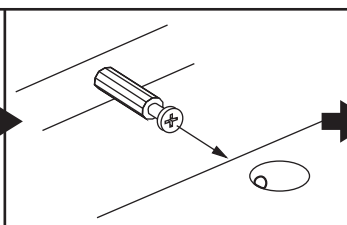
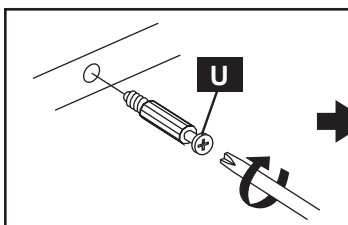
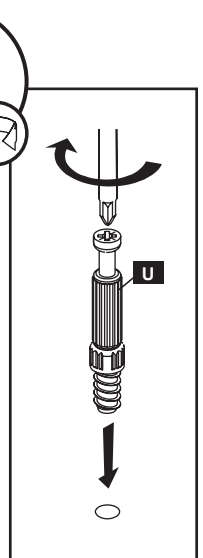
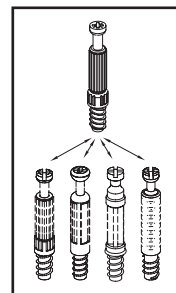
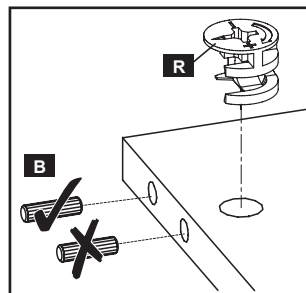
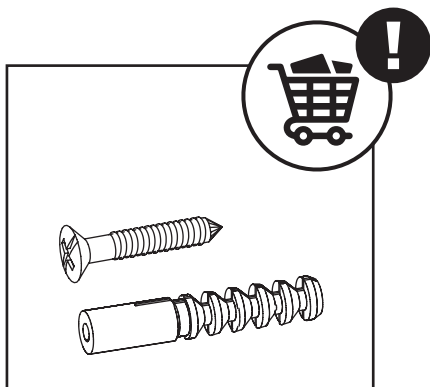
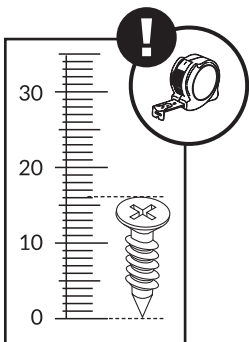
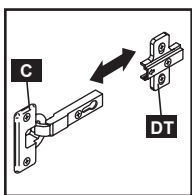

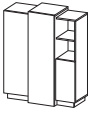

nr	↔ [mm]	↑ [mm]	↙ [mm]	Menge	Colli
E-1	344	80	16	x2	1/2
E-2	360	80	16	x1	1/2
E-3	260	80	16	x1	1/2
E-4	368	434	16	x1	2/2
E-5	368	434	16	x3	2/2
E-6	400	434	16	x1	2/2
E-7	1314	434	16	x1	2/2
E-8	1314	434	16	x1	2/2
E-9	400	384	16	x1	1/2
E-10	384	384	16	x2	1/2
E-11	400	384	16	x1	1/2
E-12	1168	384	16	x1	1/2
E-13	300	384	16	x1	2/2
E-14	284	384	16	x2	2/2
E-15	284	384	16	x1	2/2
E-16	300	384	16	x1	2/2
E-17	1168	384	16	x1	1/2
E-18	1196	396	16	x1	1/2
E-19	1326	396	16	x1	1/2
E-20	598	296	16	x1	1/2
E-21	404	1196	3	x1	2/2
E-22	382	1325	3	x1	2/2
E-23	305	1196	3	x1	2/2

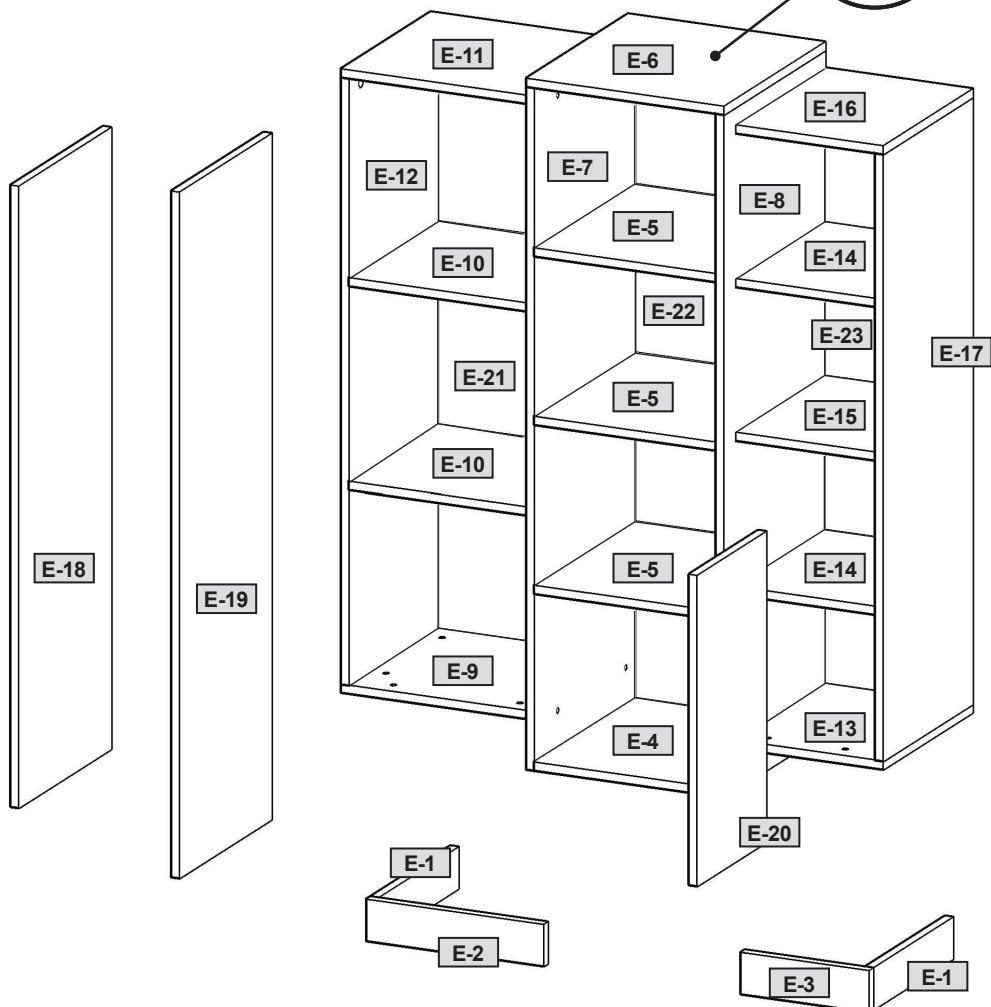
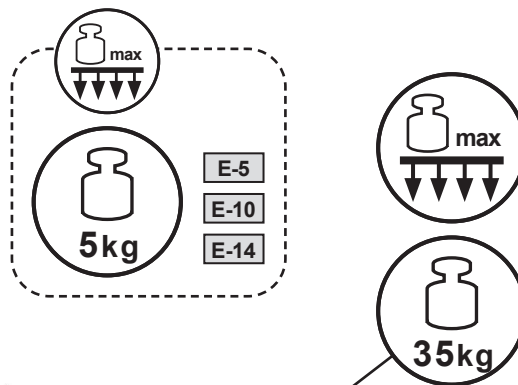

5

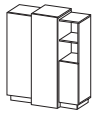

1

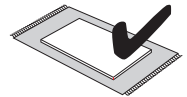
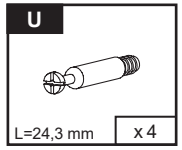
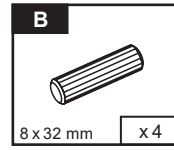
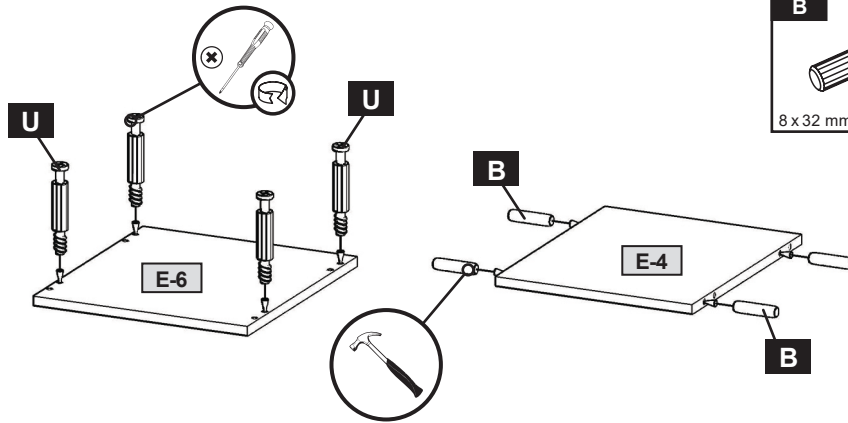
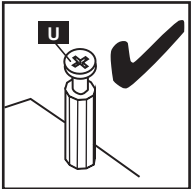
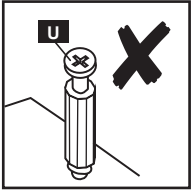

2

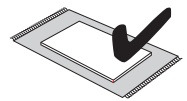
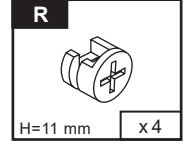
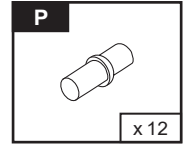
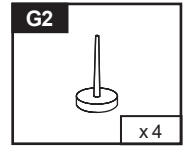
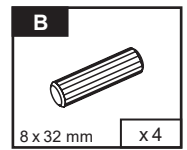
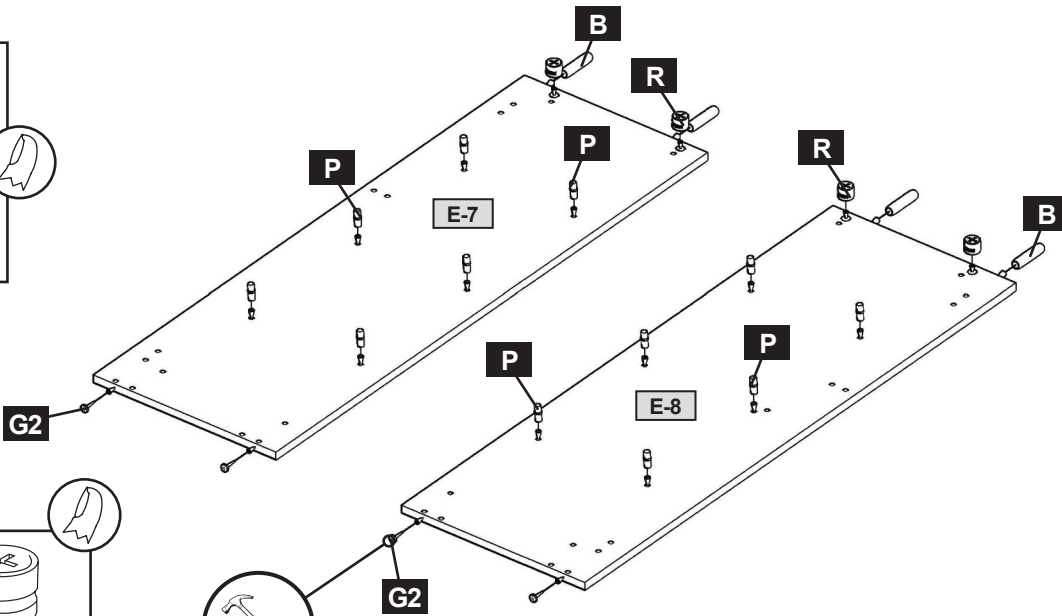
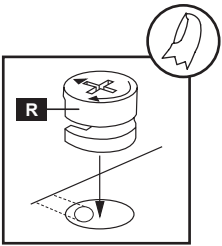
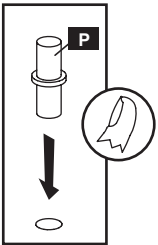

3

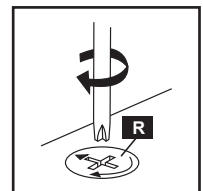
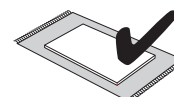
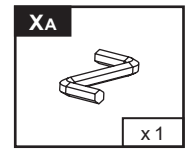
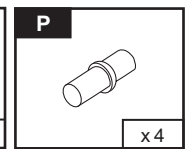
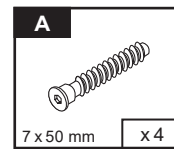
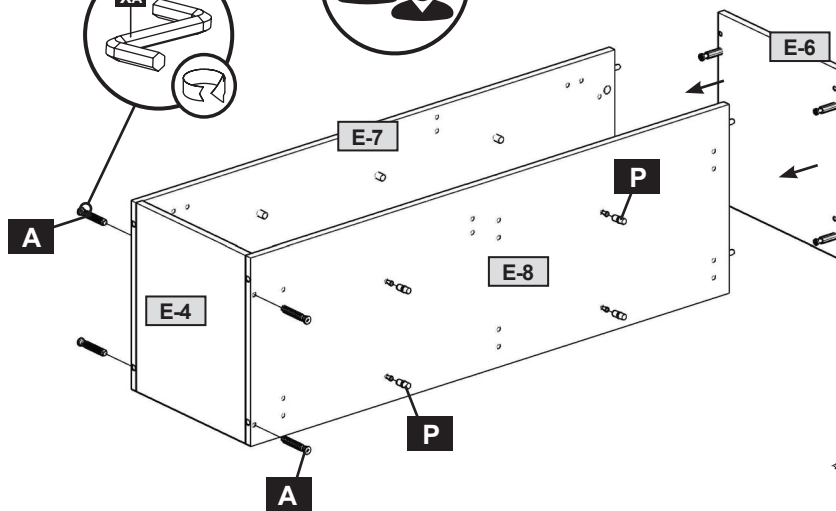
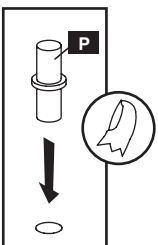
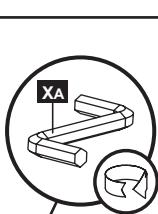

6

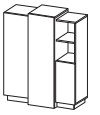

4

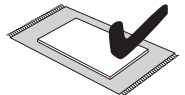
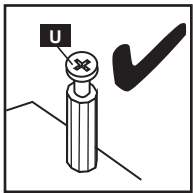
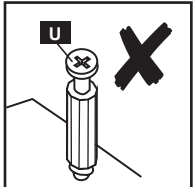
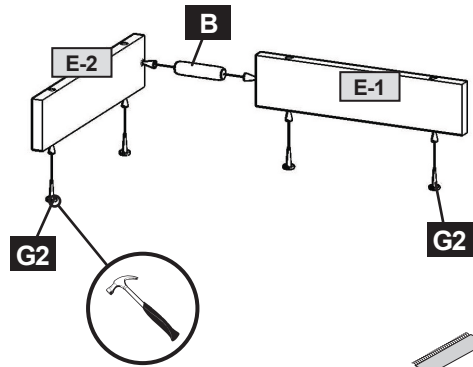
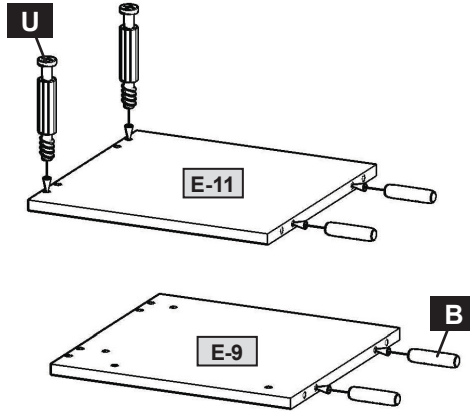
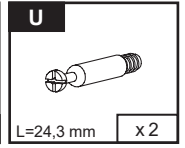
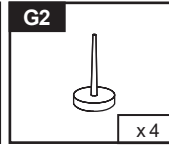
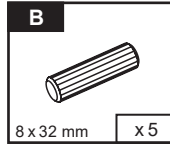

5

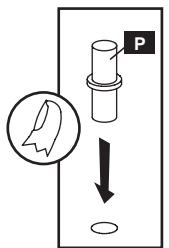
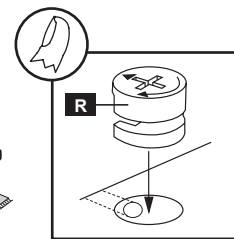
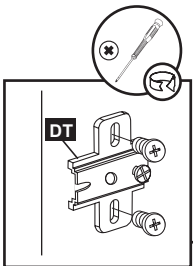
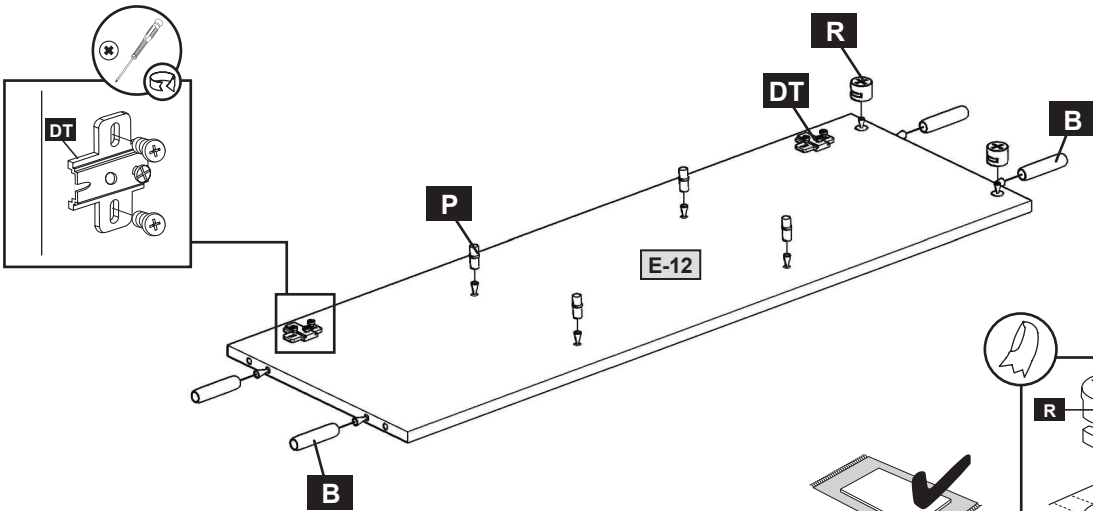
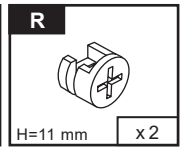
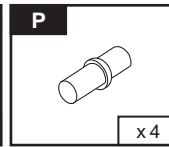
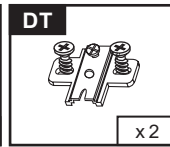
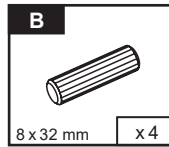

6

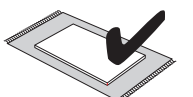
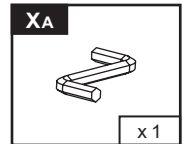
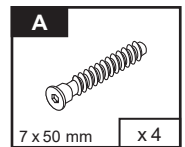
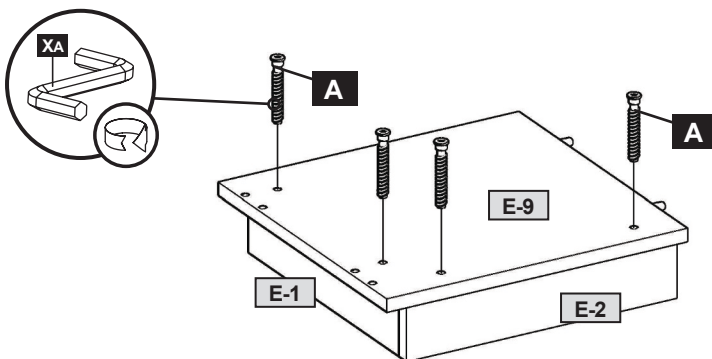

7

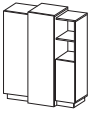

7

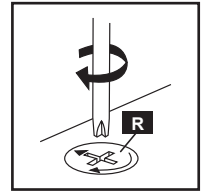
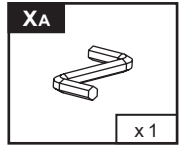
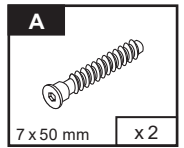
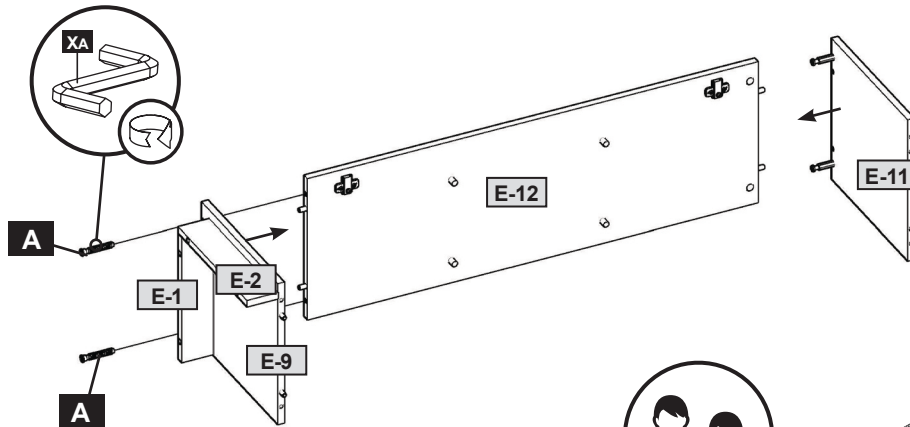

8

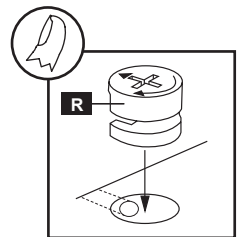
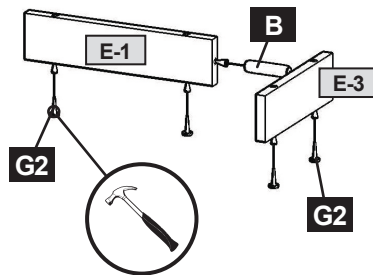
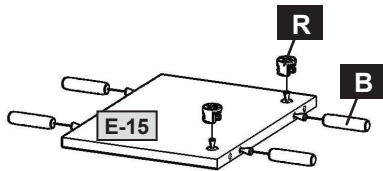
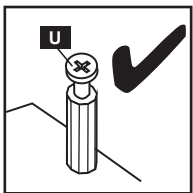
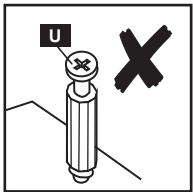
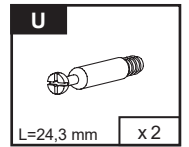
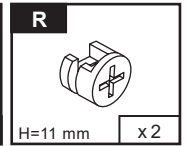
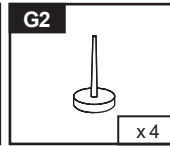
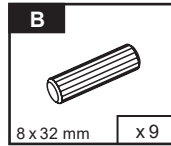
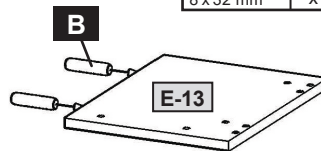
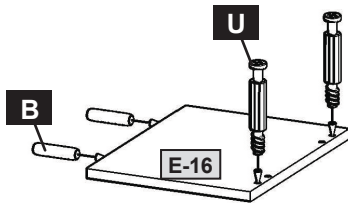

9

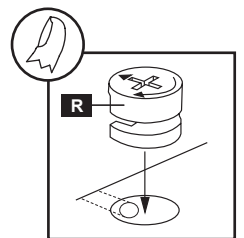
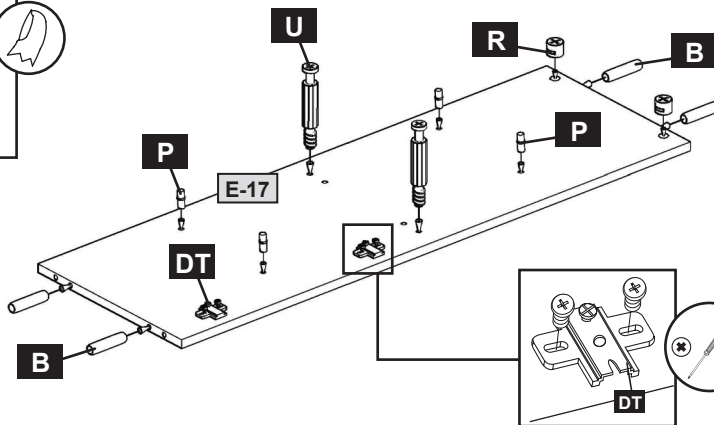
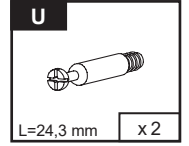
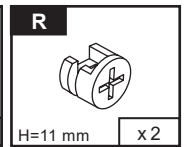
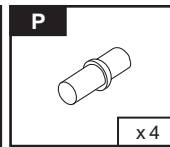
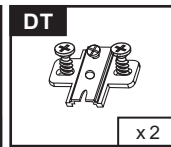
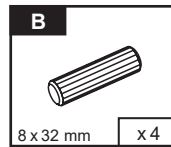
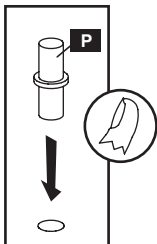
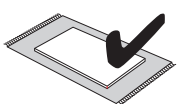
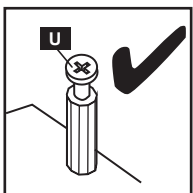
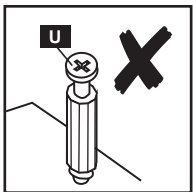

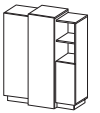

10

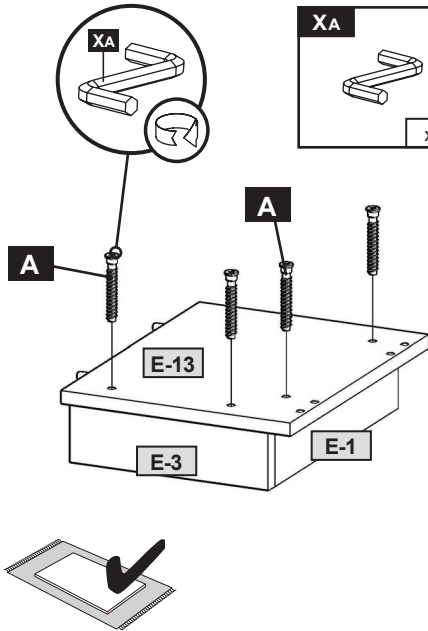
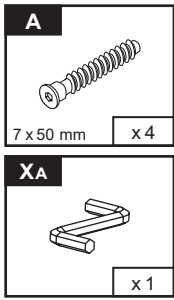

11

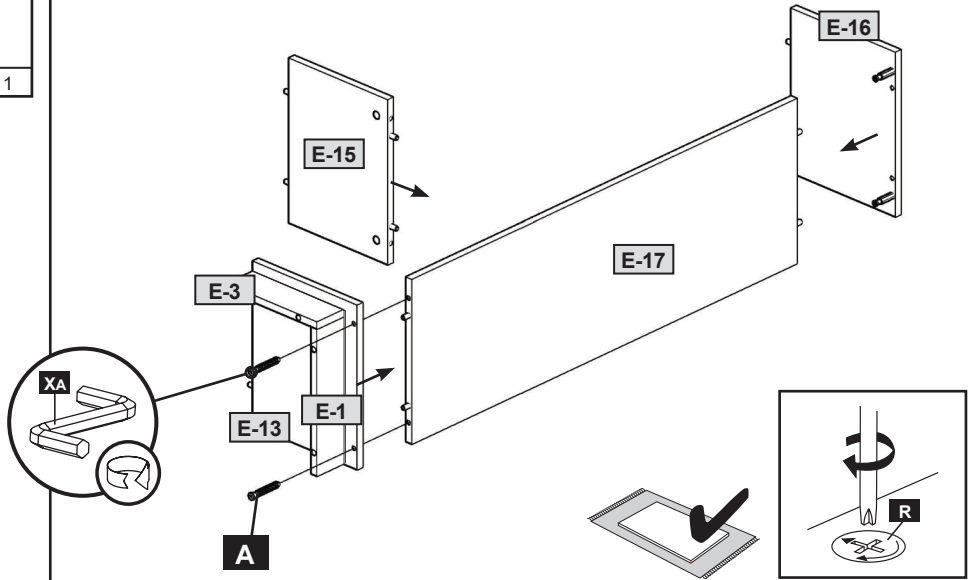
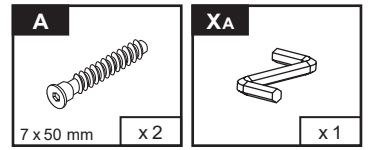

12

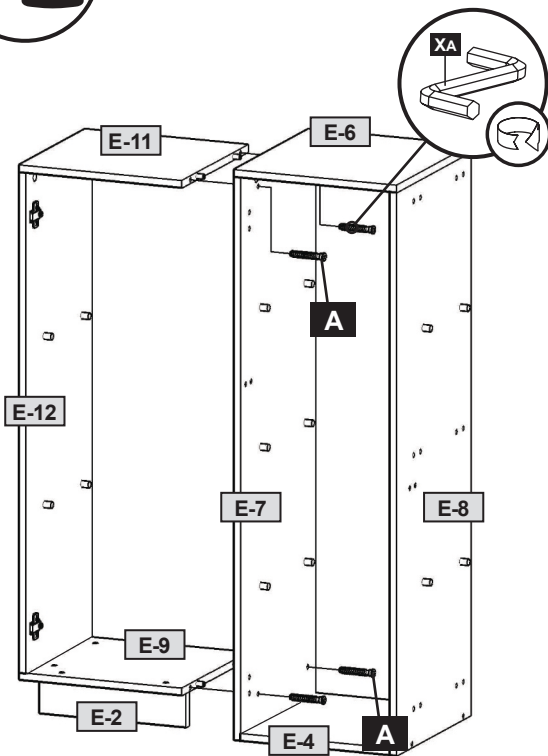
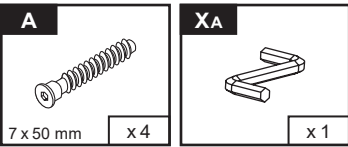

13

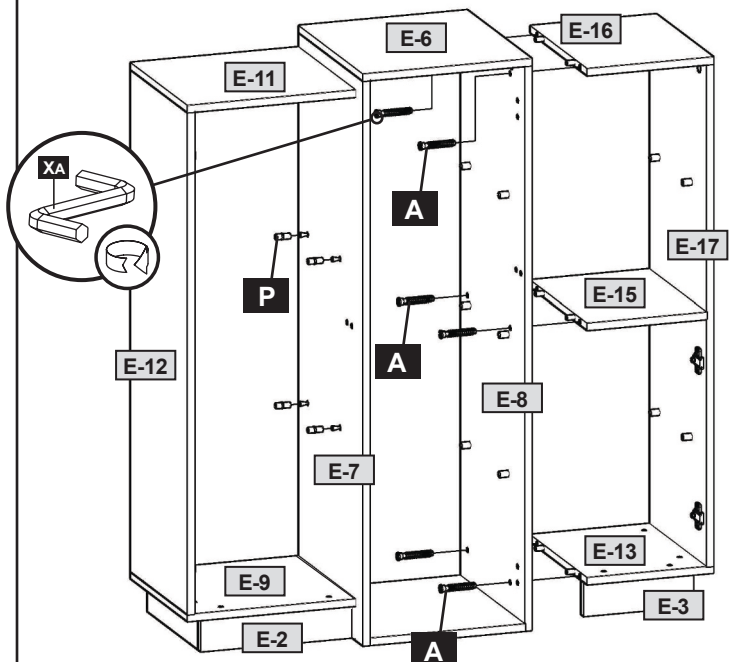
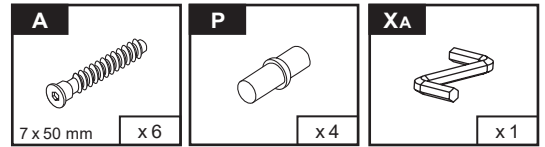

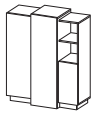

14

E2 3 x 20 mm x 48

Q2 Ø20 x 14

90°

A=B

ca. 592 mm

15

E 3,5x13mm x 12

C (P) x 6

16

E 3,5x13mm x 4

O2 x 2

ZA Ø4 x 22

ZR Ø15 x 10

A **R**

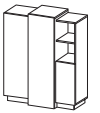

17

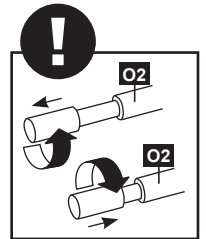
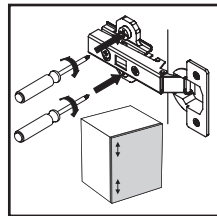
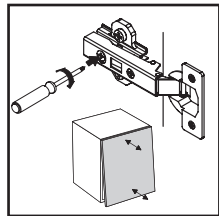
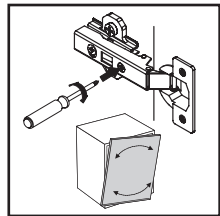
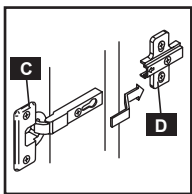
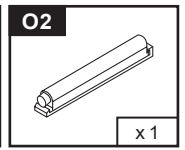
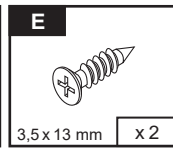
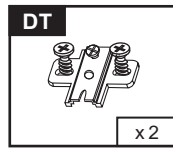
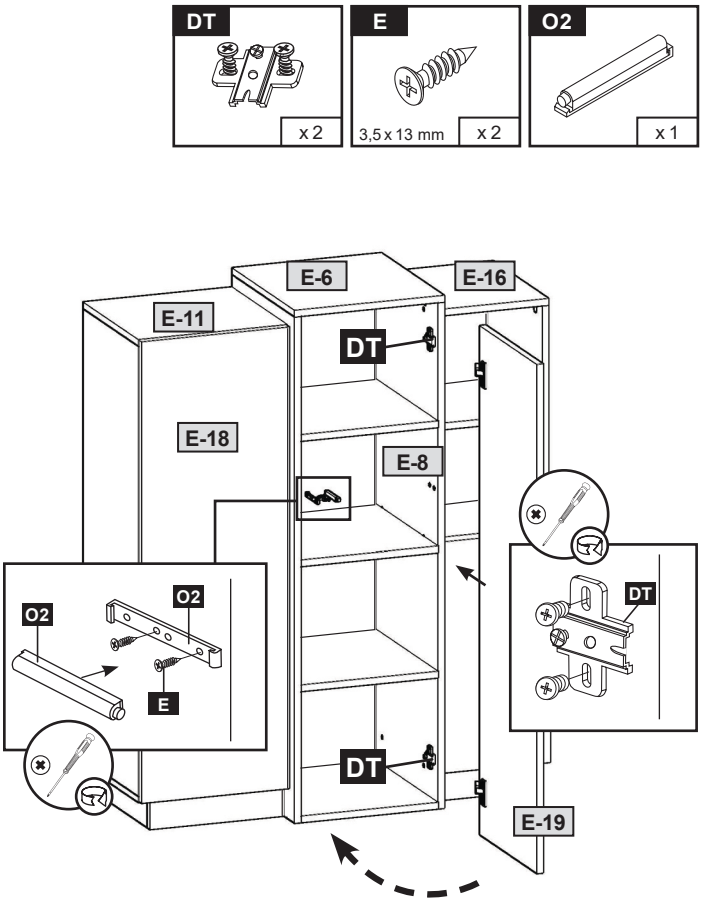
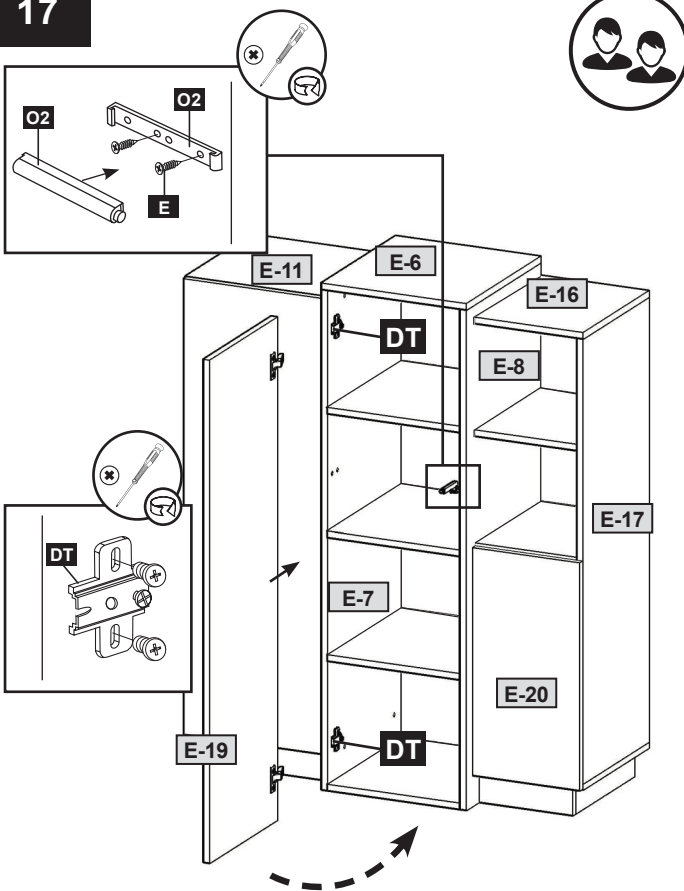

18

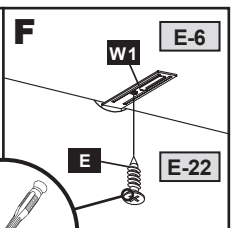
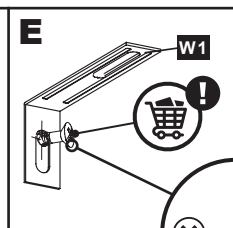
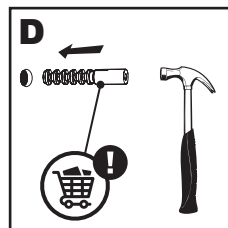
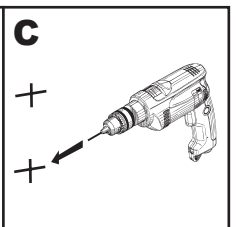
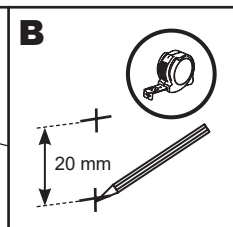
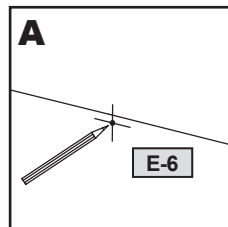
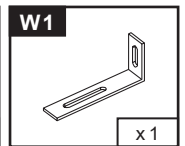
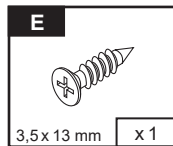
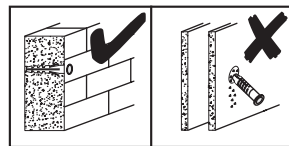
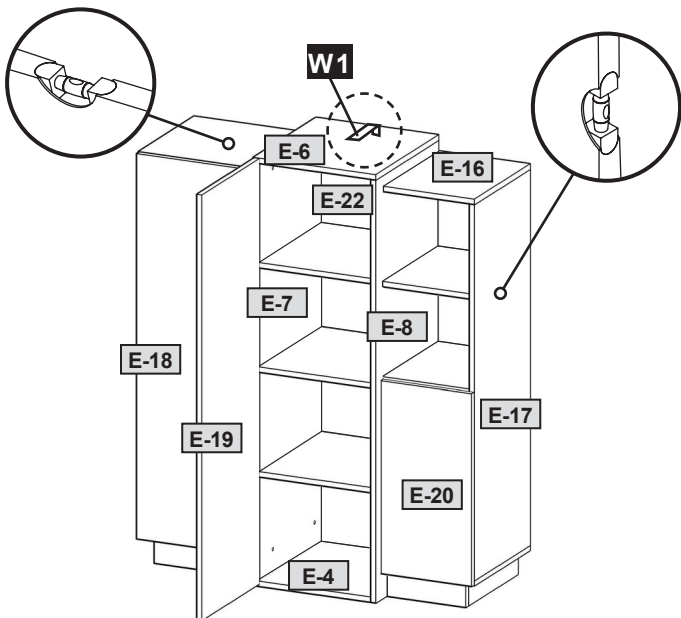

Name • Nom • Nome • Naam • Nazwa • Jméno • Názov • Név • Denumire • Isim • Название

Nr • No • N° • Номер • Č • Sz

Typ • Type • Tip • Típus • Tipo • Tun

E

D Unser Direktservice für Beschlagteile
Sollte Ihnen ein Beschlagteil fehlen, können Sie diese Servicekarte direkt an die untenstehende Nummer senden. Wir können allerdings nur Beschlagteile auf diesem Weg verschicken. Sollen Sie eine andere Beanstandung an Ihrem Möbelstück haben, so wenden Sie sich bitte direkt an Ihr Möbelhaus.

GB Our direct order service for fitting
If a fitting should be missing to you, you know this service map directly following number faxes. We can in this way send away however only fitting. If you should have another objection to your piece of furniture, then they turn please to your furniture house.

CZ Naše přímé služby pro kování
Chybí-li vám nějaký díl z kování, můžete tuto servisní kartu odfaxovat přímo na níže uvedeně číslo. Touto cestou však můžeme zoslat jen díly kování. Pokud byste reklamovali jiný díl nábytku, obraťte se přímo na svého prodejce nábytku.

F Bien étudier la notice de montage
Repérez les pièces constituant votre meuble. Regroupez et contrôlez la quincaillerie. Munissez - vous de l'outillage nécessaire. Aménagez - vous une zone de montage. Procédez au montage. Ne jamais forcer les assemblages. Resserrez les vis après quelques temps d'usage. Garder votre notice de montage, si une pièce venait à manquer, elle serait le plus clair moyen de communiquer avec votre magasin.

I Il nostro servizio diretto per l'ordine della ferramenta
Nel caso vi mancassero dei pezzi, potete spedire fax questa carta die servizi direttamente al seguente numero. Per altri reclami al vostro mobile, potete rivolgervi al vostro mobilificio.

BG Директно обслужаване на фиделителни "Обзор"
Ако ви недостават частковане, можете послати тута сервисна карта по факс на нисе указане число. Титуваваме да ви доставим само частковане. Ако имате друге претензии по отношение на мебелта, молиме да се обърнете директно на вашия магазин.

NL Onze directservice voor losse onderdelen
Wanneer er een onderdeel mist kunt u deze servicekaart direct aan onderstaand faxnummer sturen. Wij kunnen alleen langs deze weg onderdelen versturen. Mocht u een ander probleem aan uw meubel hebben verzeken wij u contact op te nemen met uw meubeldealer.

PL Nasz bezpośredni serwis części montażowych
Jeżeli brakuje części koniecznych do montażu, prosimy o przesłanie nam tej karty serwisowej na niżej podany numer faxu. Możemy w ten sposób przysłać państwu tylko brakujące części. W przypadku innych obiekacji dotyczących mebla, prosimy o zgłoszenie ich do salonu meblowego w którym został dokonany zakup.

HR Servis za okove
U slučaju da nedostaje neki od dijelova molimo vas da na doje navedeni Fax broj posaljete ovaj servisni obrazac. Na ovaj način mogu se dostaviti samo okovi. U slučaju da imate dodatne prigovore vezane uz komad namještaja molimo vas da se obratite izravno trgovini namještaja gdje je isti kupljen.

HU Direktszoállításunk vasalatok esetén
Ha hiányzik egy vasalat, ezt a kártyát közvetlenül elfaxolhatja az alább található faxszámra. Azonban csakis vasalatoskat tudunk így küldeni. Amennyiben másféle reklamációt áll fenn bútordarabját illetően, forduljon közvetlenül a bútornáhhoz.

SK Naše priamy servis pre časti kovania
Ak by Vám chýbala nejaká časť kovania, môžete poslať túto servisnú kartu poslať faxom priamo na nižšie uvedené faxové číslo. Díly kovania vieme poslať iba týmto spôsobom. Ak by ste mali inú reklamáciu ohľadom Vášho nábytku, obraťte sa priamo na Vašu predajnú nábytku.

SLO Naše direktno služne storitve za okovje
Če vam manjka kakšno okovje, lahko to servisno kartico pošljete po faksu direktno na spodnjo številko. Po tej poti vam lahko pošljemo samo okovje. Če želite reklamirati kakšen drug del pohištva, se obrnite neposredno na vašo trgovino pohitva.







RO Service-ul nostru direct pentru feronerie
În cazul în care vă lipsesc o piesă de feronerie puteți să trimiteți direct această card de service pe fax la numărul de mai jos. Noi nu putem expedia piese de feronerie decât pe această cale. Dacă aveți o altă reclamație referitoare la piesa de mobilier, atunci vă rugăm să vă adresați direct la magazinul dvs. de mobilă.

RUS Наш прямой сервис для поставок фурнитуры
Если окажется, что Вам не хватает того или иного элемента фурнитуры, Вы можете отправить сервисную карту по Факсу непосредственно на нижеприведенный номер. Однако, таким образом мы можем пересылать лишь фурнитуру. Если же у Вас возникнут иные претензии относительно приобретенной мебели, пожалуйста, обращайтесь непосредственно в организацию, осуществившую продажу.

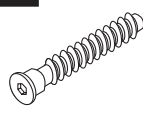
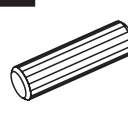
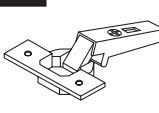
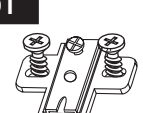
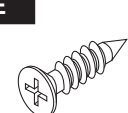
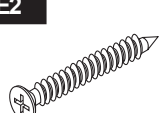
S Vår direktservice för beslagdelar
Om du saknar en beslagdel kan du faxa detta servicekort direkt till numret som anges ned. Tänk på att detta är den enda möjligheten att skicka beslagdelar till dig. Om du vill reklamera din möbel av en annan anledning måste du kontakta ditt möbelhus direkt.

ES Nuestro servicio directo para accesorios
Si le falta algún accesorio, puede enviar esta tarjeta de servicio directamente a la siguiente dirección. No obstante, por este método solo podemos enviar accesorios. Si tiene alguna otra objeción sobre su mueble, consulte directamente con su mueblera.

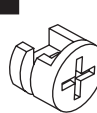
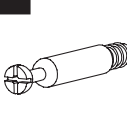
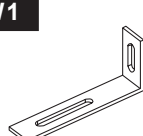
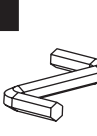
TR Donatılar için doğrudan servisimiz
Bir donatınız eksikse bu servis kartını doğrudan aşağıda bulunan adrese doğrudan mail yazabilirsiniz. Sadece bu yolla donatılar gönderilebilir. Mobilyanızda başka şikayetleriniz varsa lütfen doğrudan mobilya satıcınıza danışın.

A  7 x 50 mm X ...	B  8 x 32 mm X ...	C  (P) X ...
DT  X ...	E  3,5 x 13 mm X ...	E2  3 x 20 mm X ...
G2  X ...	O2  X ...	P  X ...
Q2  Ø 20 X ...	R  H=11 mm X ...	U  L=24,3 mm X ...
W1  X ...	XA  X ...	ZA  Ø 4 X ...
ZR  Ø 15 X ...		

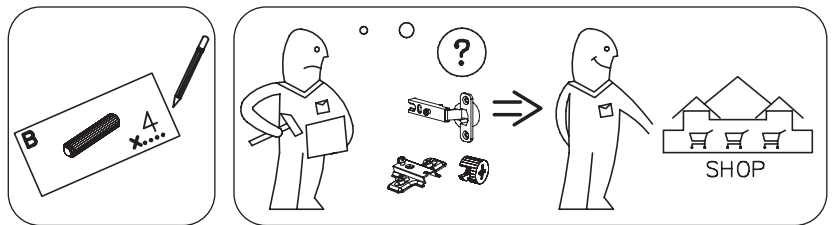

Name • Nom • Nome • Naam • Nazwa • Jméno • Názov • Név • Denumire • Isim • Название

Nr • No • N° • Номер • Č • Sz

Typ • Type • Tip • Típus • Tipo • Tun

--

E

D

Unser Direktservice für Beschlagteile
Sollte Ihnen ein Beschlagteil fehlen, können Sie diese Servicekarte direct an die untenstehende Nummer senden. Wir können allerdings nur Beschlagteile auf diesem Weg verschicken. Sollen Sie eine andere Beanstandung an Ihrem Möbelstück haben, so wenden Sie sich bitte direkt an Ihr Möbelhaus.

GB

Our direct order service for fitting
If a fitting should be missing to you, you know this service map directly following number faxes. We can in this way send away however only fitting. If you should have another objection to your piece of furniture, then they turn please to your furniture house.

CZ

Naše přímé služby pro kování
Chybí-li vám nějaký díl z kování, můžete tuto servisní kartu odfaxovat přímo na níže uvedené číslo. Touto cestou však můžeme zaslát jen díly z kování. Pokud byste reklamovali jiný díl nábytku, obraťte se přímo na svého prodejce nábytku.

F

Bien étudier la notice de montage
Respectez les pièces constituant votre meuble. Regroupez et contrôlez la quincaillerie. Munissez-vous de l'outillage nécessaire. Aménagez-vous une zone de montage. Procédez au montage. Ne jamais forcer les assemblages. Resserrez les vis après quelques temps d'usage. Garder votre notice de montage, si une pièce venait à manquer, elle serait le plus clair moyen de communiquer avec votre magasin.

I

Il nostro servizio diretto per l'ordine della ferramenta
Nel caso vi mancassero dei pezzi, potete spedire fax questa carta die servizi direttamente al seguente numero. Per altri reclami al vostro mobile, potete rivolgervi al vostro mobilificio.

BG

Директно обслужаване на електрични делци "Обзор"
Ако ви недостига некои од делцима, можете директно да испратите овај сервисни образац на бројот подолу. На овој начин не можеме да испратиме ништо друго осим делцима. Ако имате друга жалба на својот мебел, молиме да се обратите директно на продавача на мебелот.

NL

Onze directservice voor losse onderdelen
Wanneer er een onderdeel mist kunt u deze servicekaart direct aan onderstaand faxnummer sturen. Wij kunnen alleen langs deze weg onderdelen versturen. Mocht u een ander probleem aan uw meubel hebben verzoeken wij u contact op te nemen met uw meubeldealer.

PL

Nasz bezpośredni serwis części montażowych
Jeżeli brakuje części koniecznych do montażu, prosimy o przesłanie nam tej karty serwisowej na niżej podany numer faxu. Możemy w ten sposób przysłać państwu tylko brakujące części. W przypadku innych obiekcyj dotyczących mebla, prosimy o zgłoszenie ich do salonu meblowego w którym został dokonany zakup.

HR

Servis za okove
U slučaju da nedostaje neki od dijelova molimo vas da na dojde navešteni Fax broj posaljete ovaj servisni obrazac. Na ovaj način mogu se dostaviti samo okovi. U slučaju da imate dodatne prigovore vezane uz komad namještaja molimo vas da se obratite izravno trgovini namještaja gdje je isti kupljen.

HU

Direktszolgálatunk vasalatók esetén
Ha hiányzik egy vasalató, ezt a kártyát közvetlenül elfaxolhatja az alább található faxszámra. Azonban csakis vasalatókat tudunk így küldeni. Amennyiben másféle reklamáció áll fenn bútoráruházjait illetően, forduljon közvetlenül a bútorházzhoz.

SK

Naše priamy servis pre časti kovania
Ak by Vám chýbala nejaká časť kovania, môžete poslať túto servisnú kartu poslať faxom priamo na nižšie uvedené číslo. Dily kovania vieme poslať iba týmto spôsobom. Ak by ste mali inú reklamáciu ohľadom Vášho nábytku, obráťte sa priamo na Vašu predajnú nábytku.

SLO

Naše direktno služne storitve za okovje
Če vam manjka kakšno okovje, lahko to servisno kartico pošljete po faxu direktno na spodnjo številko. Po tej poti vam lahko pošljemo samo okovje. Če želite reklamirati kakšen drug del pohištva, se obrnite neposredno na vašo trgovino pohištva.

RO

Service-ul nostru direct pentru feronerie
In cazul in care va lipseste o piesa de feronerie puteti sa trimitezi direct acest card de service pe fax la numarul de mai jos. Noi nu putem expedia piese de feronerie decat pe acestasi cale. Decat avezi o alta reclamatie referitoare la piesa de mobilier, atunci va rugam sa va adresati direct la magazinul dvs. de mobilier.

RUS

Наш прямой сервис для поставок фурнитуры
Если окажется, что Вам не хватает того или иного элемента фурнитуры, Вы можете отправить сервисную карту по Факсу непосредственно на нижеприведенный номер. Однако, таким образом мы можем пересылать лишь фурнитуру. Если же у Вас возникнут иные претензии относительно приобретенной мебели, пожалуйста, обращайтесь непосредственно в организацию, осуществляющую продажу.

S

Vår direktservice för beslagdelar
Om du saknar en beslagdel kan du faxa detta servicekort direkt till numret som anges ned. Tänk på att detta är den enda möjligheten att skicka beslagdelar till dig. Om du vill reklamera din möbel av en annan anledning måste du kontakta ditt möbelhus direkt.

ES

Nuestro servicio directo para accesorios
Si le falta algún accesorio, puede enviar esta tarjeta de servicio directamente a la siguiente dirección. No obstante, por este método solo podemos enviar accesorios. Si tiene alguna otra objeción sobre su mueble, consulte directamente con su mueblería.

TR

Donatilar için doğrudan servisimiz
Bir donatınız eksikse bu servis kartını doğrudan aşağıda bulunan adrese doğrudan mail yazabilirsiniz. Sadece bu yolla donatılar gönderilebilir. Mobilyanızda başka şikayetleriniz varsa lütfen doğrudan mobilya satıcınıza danışın.

nr	↔ [mm]	↑ [mm]	↙ ↗ [mm]	Menge	Colli
E-1	344	80	16	x 2	1/2
E-2	360	80	16	x 1	1/2
E-3	260	80	16	x 1	1/2
E-4	368	434	16	x 1	2/2
E-5	368	434	16	x 3	2/2
E-6	400	434	16	x 1	2/2
E-7	1314	434	16	x 1	2/2
E-8	1314	434	16	x 1	2/2
E-9	400	384	16	x 1	1/2
E-10	384	384	16	x 2	1/2
E-11	400	384	16	x 1	1/2
E-12	1168	384	16	x 1	1/2
E-13	300	384	16	x 1	2/2
E-14	284	384	16	x 2	2/2
E-15	284	384	16	x 1	2/2
E-16	300	384	16	x 1	2/2
E-17	1168	384	16	x 1	1/2
E-18	1196	396	16	x 1	1/2
E-19	1326	396	16	x 1	1/2
E-20	598	296	16	x 1	1/2
E-21	404	1196	3	x 1	2/2
E-22	382	1325	3	x 1	2/2
E-23	305	1196	3	x 1	2/2

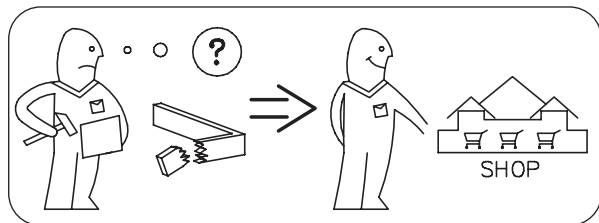
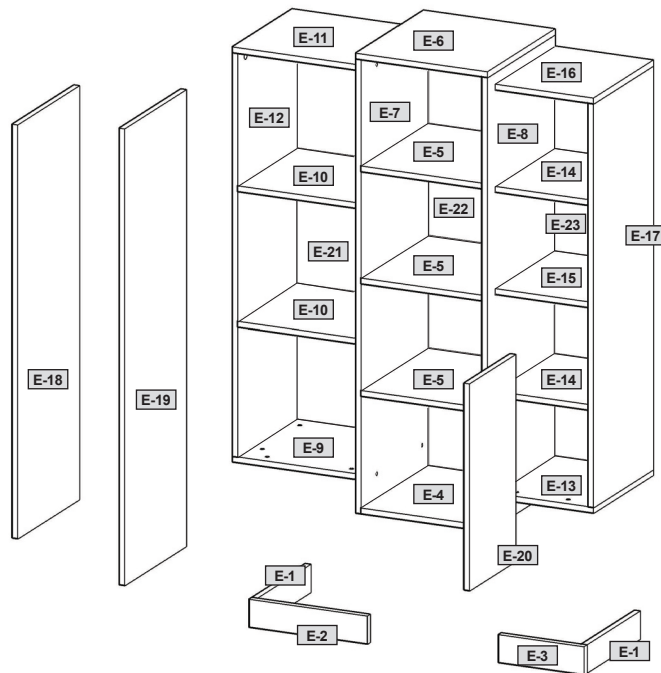



Uwaga - Upozornění - Achtung - Attention - Caution - Figyelem
 Attenzione - Opgelet - Atenție - Upozornenie - Dikkat

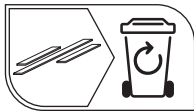
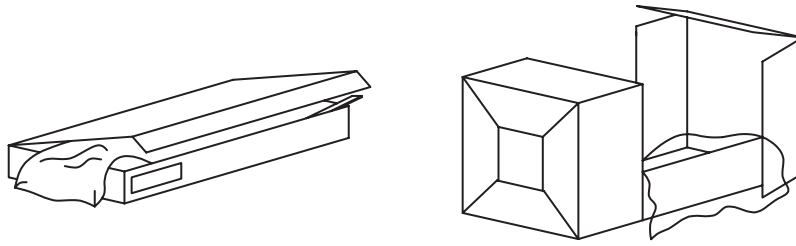

50
FOR

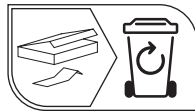

20
CFAP

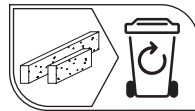

06
PS

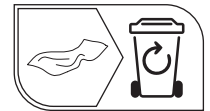

03
PVC

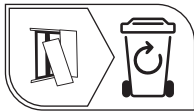
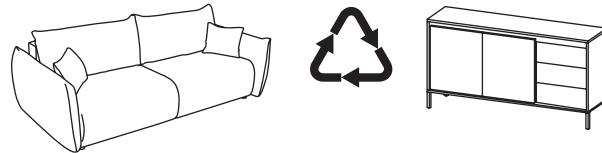

50
FOR



61
TEX

62
TEX

01
PET

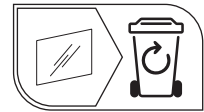

70
GLS

78
GLS

79
GLS

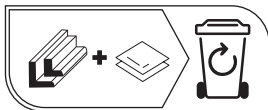

40
FE

41
ALU

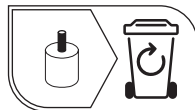

50
FOR

40
FE

03
PVC

03
PCW

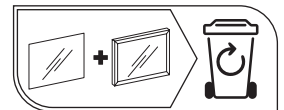

96
GLS + ALU

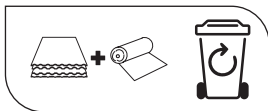

05
PP

05
PEHD

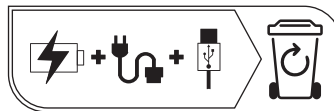

19
Alkaline

11
NiMH

10
NiCD

08
Lead

12
Li

40
FE

03
PVC

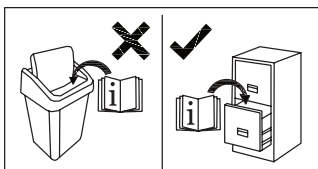

Producent - Produzent - Üretici - Producteur - Výrobce -
 Termelő - Producer - Produttore - Producător - Productor

MEBLE LASKI KACZOROWSKAPSK.

Laski, ul. Kępińska 21, 63-620 Trzcinica
 meble-laski@meble-laski.com.pl



Uwaga - Upozornění - Achtung - Attention - Caution - Figyelem
 Attenzione - Opgelet - Atenție - Upozornenie - Dikkat

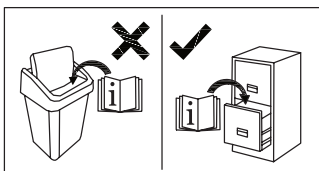
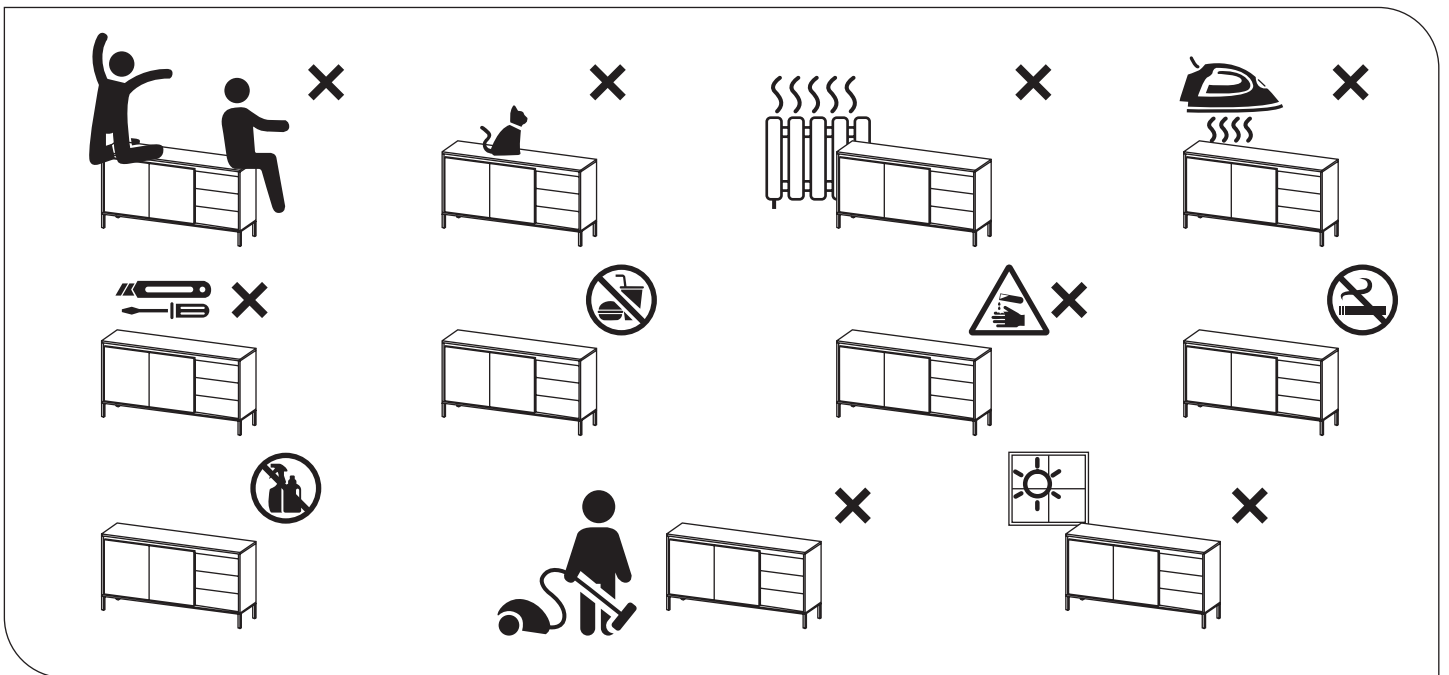
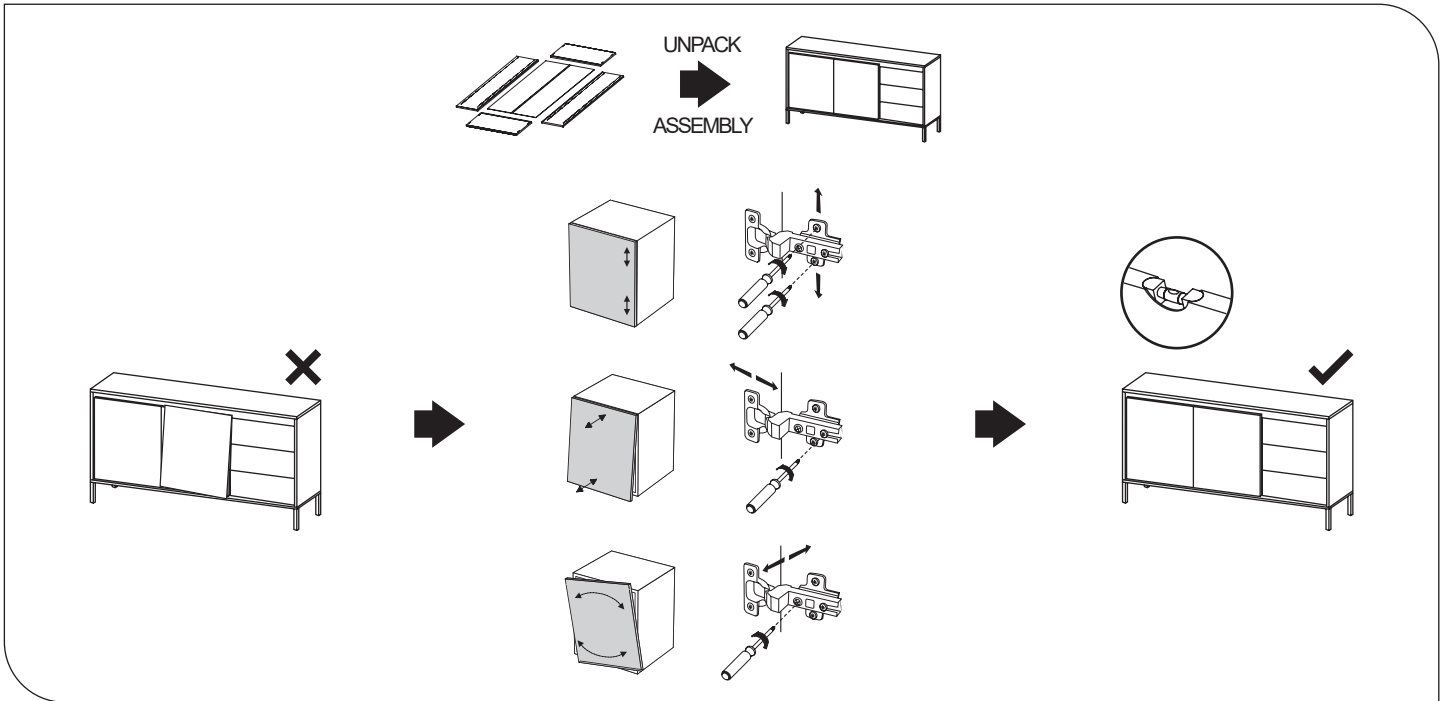
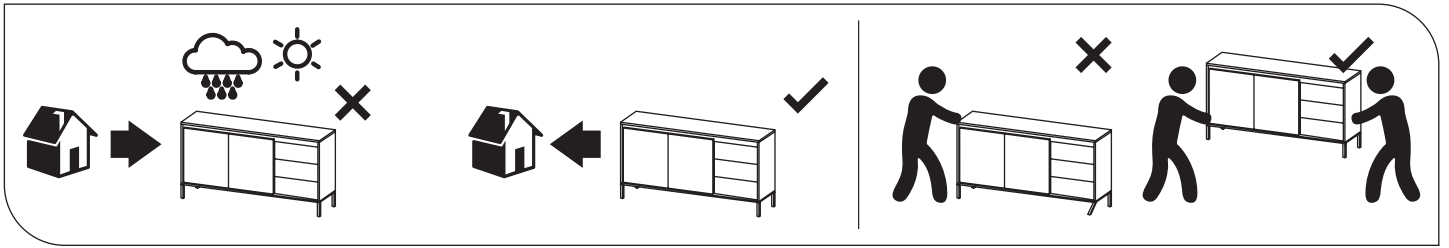

Producent - Produzent - Üretici - Producteur - Výrobce -
 Termelő - Producer - Produttore - Producător - Productor
MEBLE LASKI KACZOROWSKA SP. K.
 Laski, ul. Kępińska 21, 63-620 Trzcinica
 meble-laski@meble-laski.com.pl